

Owner's Manual & Safety Instructions

Save This Manual Keep this manual for the safety warnings and precautions, assembly, operating, inspection, maintenance and cleaning procedures. Write the product's serial number in the back of the manual near the assembly diagram (or month and year of purchase if product has no number). Keep this manual and the receipt in a safe and dry place for future reference.

CENTRALPNEUMATIC®

40 lb. capacity floor blast cabinet



Visit our website at: <http://www.harborfreight.com>
Email our technical support at: tech@harborfreight.com

ITEM 93608

When unpacking, make sure that the product is intact and undamaged. If any parts are missing or broken, please call 1-800-444-3353 as soon as possible.

Copyright© 2011 by Harbor Freight Tools®. All rights reserved.
No portion of this manual or any artwork contained herein may be reproduced in any shape or form without the express written consent of Harbor Freight Tools. Diagrams within this manual may not be drawn proportionally. Due to continuing improvements, actual product may differ slightly from the product described herein. Tools required for assembly and service may not be included.

⚠ WARNING





**Read this material before using this product.
Failure to do so can result in serious injury.
SAVE THIS MANUAL.**

Table of Contents

Safety	2	Maintenance	16
Specifications	6	Parts List and Diagram	18
Setup	7	Warranty	20
Operation.....	14		

CENTRALPNEUMATIC®

WARNING SYMBOLS AND DEFINITIONS

	This is the safety alert symbol. It is used to alert you to potential personal injury hazards. Obey all safety messages that follow this symbol to avoid possible injury or death.
	Indicates a hazardous situation which, if not avoided, will result in death or serious injury.
	Indicates a hazardous situation which, if not avoided, could result in death or serious injury.
	Indicates a hazardous situation which, if not avoided, could result in minor or moderate injury.
	Addresses practices not related to personal injury.

IMPORTANT SAFETY INSTRUCTIONS

INSTRUCTIONS PERTAINING TO A RISK OF FIRE, ELECTRIC SHOCK, OR INJURY TO PERSONS

WARNING – When using tools, basic precautions should always be followed, including the following:

General

To reduce the risks of electric shock, fire, and injury to persons, read all the instructions before using the tool.

Work Area

1. **Keep the work area clean and well lighted.** Cluttered benches and dark areas increase the risks of electric shock, fire, and injury to persons.
2. **Do not operate the tool in explosive atmospheres, such as in the presence of flammable liquids, gases, or dust.** The tool is able to create sparks resulting in the ignition of the dust or fumes.
3. **Keep bystanders, children, and visitors away while operating the tool.** Distractions are able to result in the loss of control of the tool.

Personal Safety

1. **Stay alert. Watch what you are doing and use common sense when operating the tool. Do not use the tool while tired or under the influence of drugs, alcohol, or medication.** A moment of inattention while operating the tool increases the risk of injury to persons.
2. **Dress properly. Do not wear loose clothing or jewelry. Contain long hair. Keep hair, clothing, and gloves away from moving parts.** Loose clothes, jewelry, or long hair increases the risk of injury to persons as a result of being caught in moving parts.
3. **Avoid unintentional starting. Be sure the trigger is released before connecting to the air supply.** Do not connect the tool to the air supply with the switch on.
4. **Remove adjusting keys and wrenches before turning the tool on.** A wrench or a key that is left attached to a rotating part of the tool increases the risk of personal injury.

5. **Do not overreach. Keep proper footing and balance at all times.** Proper footing and balance enables better control of the tool in unexpected situations.
6.  **Use safety equipment.** A dust mask, non-skid safety shoes and a hard hat must be used for the applicable conditions.
7.  **Always wear eye protection.** Wear ANSI-approved safety goggles.
8.  **Always wear hearing protection when using the tool.** Prolonged exposure to high intensity noise is able to cause hearing loss.

Tool Use and Care

1. **Use clamps or another practical way to secure and support the workpiece to a stable platform.** Holding the work by hand or against the body is unstable and is able to lead to loss of control.
2. **Do not force the tool.** Use the correct tool for the application. The correct tool will do the job better and safer at the rate for which the tool is designed.
3. **Do not use the tool if the switch does not turn the tool on or off.** Any tool that cannot be controlled with the switch is dangerous and must be repaired.
4. **Disconnect the tool from the air source before making any adjustments, changing accessories, or storing the tool.** Such preventive safety measures reduce the risk of starting the tool unintentionally. Turn off and detach the air supply, safely discharge any residual air pressure, and release the throttle and/or turn the switch to its off position before leaving the work area.
5. **Store the tool when it is idle out of reach of children and other untrained persons.** A tool is dangerous in the hands of untrained users.
6. **Maintain the tool with care.**
7. **Check for misalignment or binding of moving parts, breakage of parts, and any other condition that affects the tool's operation.** If damaged, have the tool serviced before using. Many accidents are caused by poorly maintained tools. There is a risk of bursting if the tool is damaged.
8. **Use only accessories that are identified by the manufacturer for the specific tool model.** Use of an accessory not intended for use with the specific tool model, increases the risk of injury to persons.

Service

1. **Tool service must be performed only by qualified repair personnel.**
2. **When servicing a tool, use only identical replacement parts. Use only authorized parts.**

Air Source

1.  **Never connect to an air source that is capable of exceeding 200 psi.** Over pressurizing the tool may cause bursting, abnormal operation, breakage of the tool or serious injury to persons.
Use only clean, dry, regulated compressed air at the rated pressure or within the rated pressure range as marked on the tool. Always verify prior to using the tool that the air source has been adjusted to the rated air pressure or within the rated air-pressure range.
2. **Never use oxygen, carbon dioxide, combustible gases or any bottled gas as an air source for the tool.** Such gases are capable of explosion and serious injury to persons.





SAVE THESE INSTRUCTIONS.

Symbols and Specific Safety Instructions

Symbol Definitions

Symbol	Property or statement
PSI	Pounds per square inch of pressure
ft-lb	Foot-pounds of torque
NPT	National pipe thread, tapered
	WARNING marking concerning Risk of Eye Injury. Wear ANSI-approved eye protection.

Symbol	Property or statement
	WARNING marking concerning Risk of Hearing Loss. Wear hearing protection.
	WARNING marking concerning Risk of Respiratory Injury. Wear NIOSH-approved dust mask/respirator.
	WARNING marking concerning Risk of Explosion.

Specific Safety Instructions

1. The warnings and precautions discussed in this manual cannot cover all possible conditions and situations that may occur. It must be understood by the operator that common sense and caution are factors which cannot be built into this product, but must be supplied by the operator.
2. **WARNING:** This product, when used for abrasive blasting and similar applications, produces chemicals known to the State of California to cause cancer and birth defects (or other reproductive harm). (California Health & Safety Code § 25249.5, et seq.)
WARNING: The brass components of this product contain lead, a chemical known to the State of California to cause birth defects (or other reproductive harm). (California Health & Safety code § 25249.5, et seq.)
3. Obey the manual for the air compressor used to power this tool.
4. Install an in-line shutoff valve to allow immediate control over the air supply in an emergency, even if a hose is ruptured.

Assembly Precautions

1. Assemble only according to these instructions. Improper assembly can create hazards.
2. Wear ANSI-approved safety goggles and heavy-duty work gloves during assembly.
3. Keep assembly area clean and well lit.
4. Keep bystanders out of the area during assembly.
5. Do not assemble when tired or when under the influence of drugs or medication.

Silicosis and Aluminum Oxide Warnings

WARNING! Abrasive blasting with sand containing crystalline silica can cause serious or fatal respiratory disease. Exposure to crystalline silica may cause silicosis (a serious lung disease), cancer and death. Exposure to aluminum oxide (a dust generated from material removing processes) can result in eye, skin and breathing irritation. Always use a NIOSH (National Institute for Occupational Safety and Health) approved respirator and safety goggles. Avoid skin exposure. Proper ventilation in the work area is required. Read and understand the 10 recommended measures below to reduce crystalline silica exposures in the workplace and prevent silicosis and silicosis related deaths.

NIOSH recommends the following measures to reduce crystalline silica exposures in the workplace and prevent silicosis and silicosis-related deaths:

1. Prohibit silica sand (or other substances containing more than 1% crystalline silica) as an abrasive blasting material and substitute less hazardous materials.
2. Conduct air monitoring to measure worker exposures.
3. Use containment methods such as blast-cleaning machines and cabinets to control the hazard and protect adjacent workers from exposure.
4. Practice good personal hygiene to avoid unnecessary exposure to silica dust.
5. Wear washable or disposable protective clothes at the work site. Shower and change into clean clothes before leaving the work site to prevent contamination of cars, homes and other work areas.
6. Use respiratory protection when source controls cannot keep silica exposures below the NIOSH REL.
7. Provide periodic medical examinations for all workers who may be exposed to crystalline silica.
8. Post signs to warn workers about the hazard and to inform them about required protective equipment.
9. Provide workers with training that includes information about health effects, work practices and protective equipment for crystalline silica.
10. Report all cases of silicosis to State health departments and to OSHA or the Mine Safety and Health Administration (MSHA).

Vibration Precautions

This tool vibrates during use. Repeated or long-term exposure to vibration may cause temporary or permanent physical injury, particularly to the hands, arms and shoulders. To reduce the risk of vibration-related injury:

1. Anyone using vibrating tools regularly or for an extended period should first be examined by a doctor and then have regular medical check-ups to ensure medical problems are not being caused or worsened from use. Pregnant women or people who have impaired blood circulation to the hand, past hand injuries, nervous system disorders, diabetes, or Raynaud's Disease should not use this tool. If you feel any symptoms related to vibration (such as tingling, numbness, and white or blue fingers), seek medical advice as soon as possible.
2. Do not smoke during use. Nicotine reduces the blood supply to the hands and fingers, increasing the risk of vibration-related injury.
3. Use tools with the lowest vibration when there is a choice.
4. Include vibration-free periods each day of work.
5. Grip tool as lightly as possible (while still keeping safe control of it). Let the tool do the work.
6. To reduce vibration, maintain tool as explained in this manual. If abnormal vibration occurs, stop immediately.



SAVE THESE INSTRUCTIONS.

Functional Description Specifications

Average Air Consumption	9.5 CFM @ 90 PSI
Maximum Working Pressure	125 PSI
Air Inlet	1/4" -18 NPT
Abrasive Capacity	40 lb.
Dust Port	4-3/4" OD
Viewing Window	21" W x 10" H
Working Area	33-1/2" W x 22" D x 18" H
Overall Dimensions	36-1/2" W x 23" D x 54-1/2" H

Components and Controls

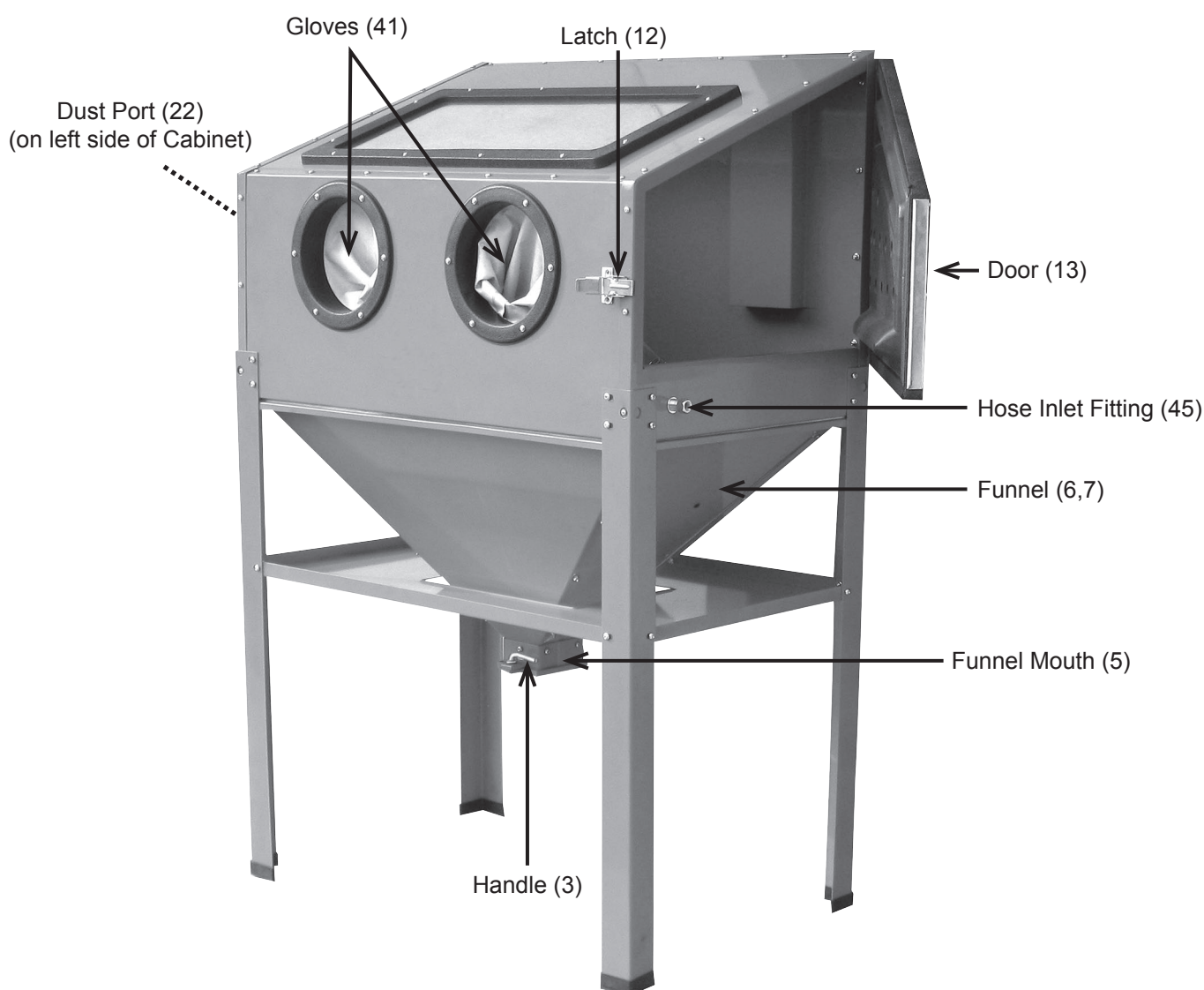

Figure A: Components and Controls

Initial Tool Set up / Assembly



Read the **ENTIRE IMPORTANT SAFETY INFORMATION** section at the beginning of this manual including all text under subheadings therein before set up or use of this product.

Note: For additional information regarding the parts listed in the following pages, refer to the Assembly Diagram near the end of this manual.

Foam Gaskets

Locate the Cabinet (48), the Cabinet Funnel (8) and the Screen Frame (7). Peel off the paper backing from the Foam Gasket that is attached to the Screen Frame. Note: The gasket will fit between the Screen Frame and the upper edge of the Cabinet Funnel. Use a punch or nail to make holes in the Foam Gasket for bolt installation

Attach the Light Clamps (37) to the inside of the Cabinet Rear Plate (19) using the Bolts (50), Flat Washers (59) and Hex Nuts (54).

Gloves

1. Secure the Glove Mounting Rings (33) and Glove Seal Rings (30) to the Cabinet Front Plate (17) using the Bolts (48), Flat Washers (59) and Hex Nuts (54).
2. Slide the Gloves (41) over the Glove Mounting Rings and secure in place with the Glove Clamps (31).

Dust Port

Attach the Dust Port (22) to the outside of the Left Cabinet Plate (18) using the Bolts (50), Flat Washers (59) and Hex Nuts (54).

Cabinet

Note: Align the three middle holes along the roof edges first, then align the remaining holes when assembling. Leave all connections loose until all bolts are in place. Use the Flange Bolts (47), Flat Washers (58) and Nuts (53) to secure the sections in place.

1. Attach the Front Cabinet Plate (17), and the Back Cabinet Plate (19) to the top edges of the Roof (16) overlapping the front and back flanges over the edges of the Roof.
2. Place the Left Cabinet Plate (18) over the edges of the Front and Back Cabinet Plates and the Roof. Align the holes of the Hinge (24) along the back edge of the Cabinet Plate and secure in place.
3. Place the Door Frame to the other side of the Front and Back Cabinet Plates and the Roof. Place the Hinge (24) over the back edge of the Door (13), aligning all holes. Secure in place.
4. After all hardware is in place, tighten all connections.

Light and Switch

1. Place the Light (39) in the Light Clamps (37) and secure with the Cable Ties (61).
2. Guide the wire of the Light out through the hole of the Cabinet Left Plate (18), and tighten the plastic nuts with the Left Plate.
3. Insert the end of the wire into the Switch (21).
4. Install the Switch (21) and Switch Cover (20) on the Cabinet Left Plate (18) with the Bolts (50), Flat Washers (59) and Nuts (54).
5. Install the Latch (12) on the Cabinet Front Plate (17) with the Bolts (50), Flat Washers (59) and Nuts (54).

Funnel

SAFETY

SETUP

OPERATION

MAINTENANCE

1. Place the Funnel Left and Right Plates (7) on the inside flanges of the Funnel Front and Rear Plates (6) and secure in place with the Bolts (47), Flat Washers (58) and Nuts (53).
2. Slide the Funnel Mouth (5) over the bottom of the assembly and secure in place with the Bolts (47), Flat Washers (58) and Nuts (53).

Legs

Align the holes of the two rear Legs (43) and Cabinet holes as shown at right, and secure in place with the Bolts (43), Flat Washers (57) and Nuts (52). Repeat with the front Legs (43), sliding the Shims (34) between the Legs and Cabinet before inserting the Bolts and securing in place.

Connecting the Funnel, Hose and Cabinet

1. Place the Bottom Plate (9), Screen Frame (10) and Steel Screen (11) on top of the Funnel and secure the assembly to the bottom of the Cabinet with the Bolts (44), Flat Washers (57) and Nuts (52).
2. Attach the Abrasive Gun Air Inlet Hose to the inside lower right side of the Cabinet and the Hose Inlet Fitting (45) to the outside, using the Flat Washers (56).
3. Slide the Suction Hose (8) end into the Funnel through the Screen.

Lower Shelf and Window

SAFETY

1. Install the Lower Shelf (2) with the Bolts (43), Flat Washers (57) and Nuts (52).
2. Layer the Protective Film (25), Glass (27), Acrylic Glass (26) and Frame (28) over the opening on the Cabinet Roof and secure in place with the Bolts (49), Flat Washers (59) and Nuts (54).

SETUP

OPERATION

MAINTENANCE

Note: This air tool may be shipped with a protective plug covering the air inlet. Remove this plug before set up.

Air Supply

⚠ WARNING



TO PREVENT SERIOUS INJURY FROM EXPLOSION:

Use only clean, dry, regulated, compressed air to power this tool.

Do not use oxygen, carbon dioxide, combustible gases, or any other bottled gas as a power source for this tool.

1. Incorporate a filter, regulator with pressure gauge, dryer, in-line shutoff valve, and quick coupler for best service, as shown on Figure K on page 12 and Figure L on page 13. **An in-line shutoff ball valve is an important safety device because it controls the air supply even if the air hose is ruptured. The shutoff valve should be a ball valve because it can be closed quickly.**
2. Attach an air hose to the compressor's air outlet. Connect the air hose to the air inlet of the tool. Other components, such as a coupler plug and quick coupler, will make operation more efficient, but are not required.
3. Turn the tool's throttle or switch to the off position; refer to Operation section for description of controls.
4. Close the in-line shutoff valve between the compressor and the tool.
5. Turn on the air compressor according to the manufacturer's directions and allow it to build up pressure until it cycles off.
6. Adjust the air compressor's output regulator so that the air output is enough to properly power the tool, but the output will not exceed the tool's maximum air pressure at any time. Adjust the pressure gradually, while checking the air output gauge to set the right pressure range.
7. Inspect the air connections for leaks. Repair any leaks found.
8. If the tool will not be used at this time, turn off and detach the air supply, safely discharge any residual air pressure, and release the throttle and/or turn the switch to its off position to prevent accidental operation.

Note: An oiler system should not be used with this tool. The oil will mix with the material being propelled, causing poor results.

⚠ WARNING! TO PREVENT SERIOUS INJURY FROM ACCIDENTAL OPERATION:

Do not install a female quick coupler on the tool.

Such a coupler contains an air valve that will allow the air tool to retain pressure and operate accidentally after the air supply is disconnected.

Note: Air flow, and therefore tool performance, can be hindered by undersized air supply components. The air hose must be long enough to reach the work area with enough extra length to allow free movement while working.

Note: Residual air pressure should not be present after the tool is disconnected from the air supply. However, it is a good safety measure to attempt to discharge the tool in a safe fashion after disconnecting to ensure that the tool is disconnected and not powered.

Figure B: Portable Air Supply Setup

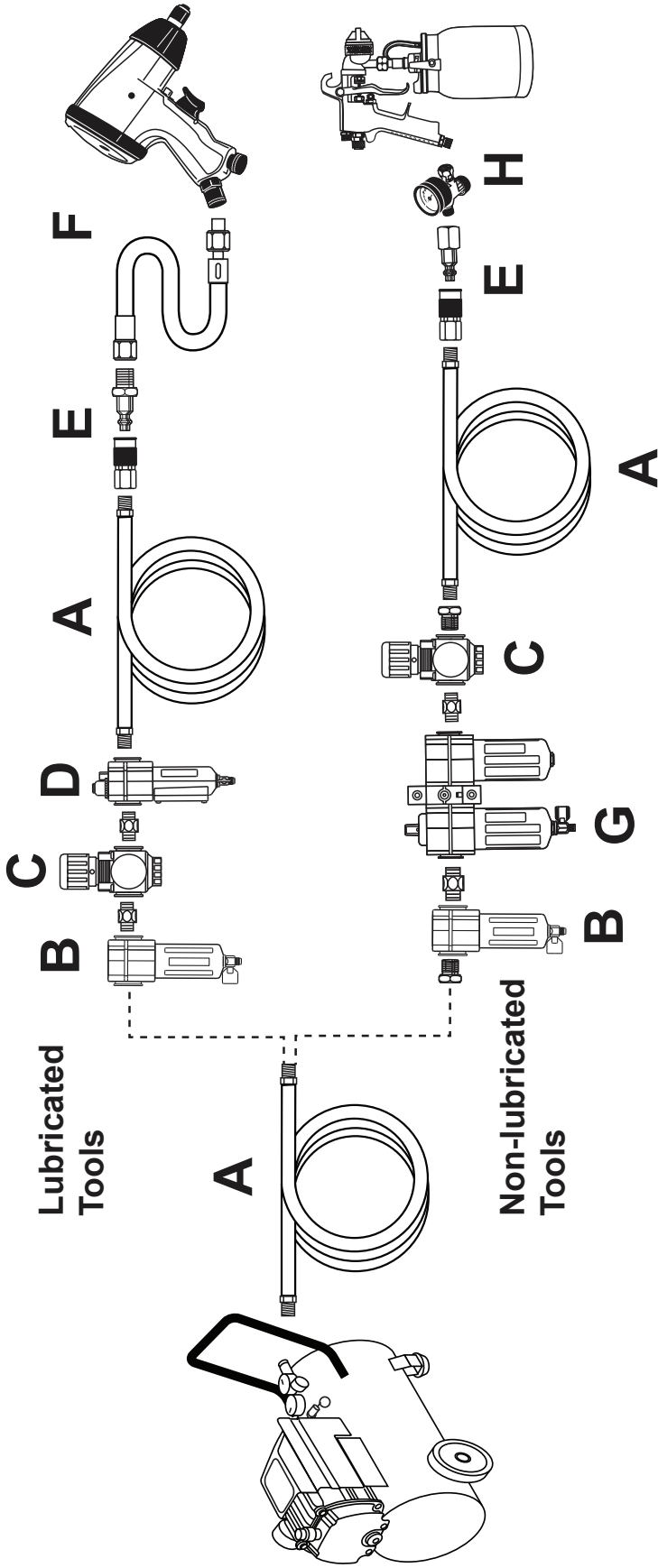

	Description	Function
A	Air Hose	Connects air to tool
B	Filter	Prevents dirt and condensation from damaging tool or work piece
C	Regulator	Adjusts air pressure to tool
D	Lubricator (optional)	For air tool lubrication
E	Coupler and Plug	Provides quick connection and release
F	Leader Hose (optional)	Increases coupler life
G	Air Cleaner / Dryer (optional)	Prevents water vapor from damaging work piece
H	Air Adjusting Valve (optional)	For fine tuning airflow at tool

Figure C: Stationary Air Supply Setup

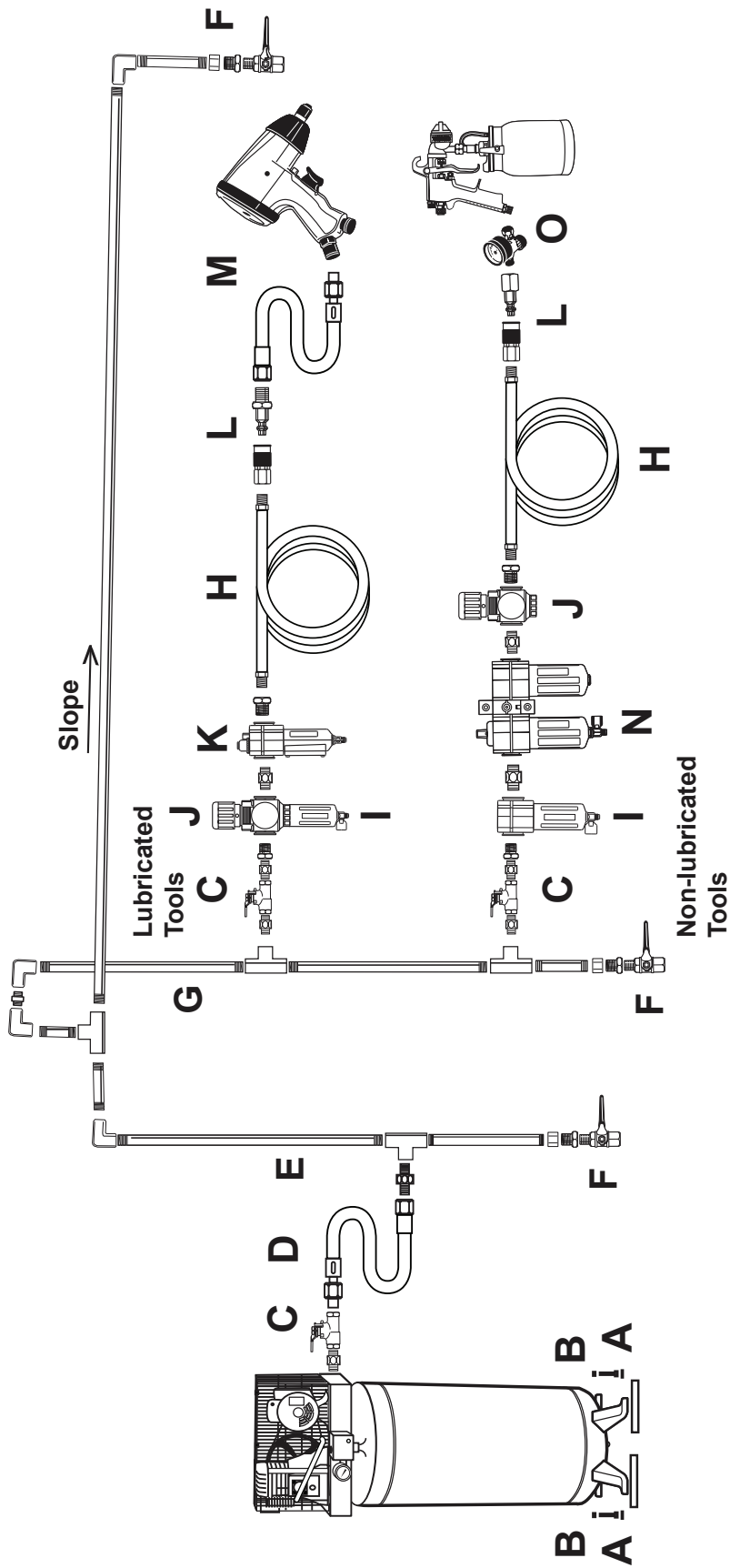

Description	Function
A	Vibration Pads For noise and vibration reduction
B	Anchor Bolts Secures air compressor in place
C	Ball Valve Isolates sections of system for maintenance
D	Isolation Hose For vibration reduction
E	Main Air Line - 3/4" minimum recommended
F	Ball Valve To drain moisture from system
G	Branch Air Line - 1/2" minimum recommended
H	Air Hose Connects air to tool
I	Filter Prevents dirt and condensation from damaging tool or work piece
J	Regulator Adjusts air pressure to tool
K	Lubricator (optional) For air tool lubrication
L	Coupler and Plug Provides quick connection and release
M	Leader Hose (optional) Increases coupler life
N	Air Cleaner / Dryer (optional) Prevents water vapor from damaging work piece
O	Air Adjusting Valve (optional) For fine tuning airflow at tool

Operating Instructions



Read the **ENTIRE IMPORTANT SAFETY INFORMATION** section at the beginning of this manual including all text under subheadings therein before set up or use of this product.

Inspect tool before use, looking for damaged, loose, and missing parts. If any problems are found, do not use tool until repaired.

Tool Set Up

⚠️ WARNING

TO PREVENT SERIOUS INJURY FROM ACCIDENTAL OPERATION:

Turn off the tool, detach the air supply, safely discharge any residual air pressure in the tool, and release the throttle and/or turn the switch to its off position before performing any inspection, maintenance, or cleaning procedures.

TO PREVENT SERIOUS INJURY:

Do not adjust or tamper with any control or component in a way not specifically explained within this manual. Improper adjustment can result in tool failure or other serious hazards.

1. Remove the Dust Port Cover (29) on the left side of the Cabinet and install a dust collection system (sold separately) to the Dust Port opening to remove media dust while blasting.
2. Fill the bottom of the Cabinet with no more than 40 pounds of fine abrasive material. Fill the funnel area about 1/2 full. To prevent clogging, do not overfill. Do not use harsh abrasive media, such as steel shot or aluminum oxide.

If not using a dust collection system, check that the Dust Port Cover is in place over the Dust Port opening on the left side of the Cabinet.

WARNING! Do not use sand or abrasives that contain crystalline silica. Abrasive blasting with sand containing crystalline silica can cause serious or fatal respiratory disease. See "Silicosis and Aluminum Oxide Warnings" on page 5.

Work Piece and Work Area Set Up

1. Designate a work area that is clean and well-lit. The work area must not allow access by children or pets to prevent distraction and injury.
2. Route the air hose along a safe route to reach the work area without creating a tripping hazard or exposing the air hose to possible damage. The air hose must be long enough to reach the work area with enough extra length to allow free movement while working.

General Operating Instructions

1. If an automatic oiler is not used, add a few drops of Pneumatic Tool Oil to the airline connection before use. Add a few drops more after each hour of continual use.
2. Connect the air compressor hose to the Hose Inlet Fitting (45).
3. Plug in and turn on the Cabinet light.
4. Turn on the vacuum of the dust collection system (sold separately).

Note: When using a vacuum dust collector, clean the filter periodically to maintain adequate suction and effectiveness of the vacuum.

5. Open the Door of the Blast Cabinet and place the workpiece in the center of the Cabinet.
6. Close the door and secure the latch.
7. Set the compressor's air pressure between 90 and 125 PSI.
8. Place your hands into the Gloves inside the Cabinet. Make sure your fingers are in the proper positions and that you can easily move your hands and grip objects.
9. Hold the workpiece in one hand, positioning your fingers so that the glove is not in the way of the area you will be blasting. While working, reposition your grip as needed to ensure that all areas of the workpiece will be contacted with the blast material.
10. Grip the Abrasive Gun with the other hand and point the nozzle at the bottom of the Cabinet.
11. Squeeze the trigger.
12. Check that the abrasive media is flowing through the suction hose with no leaks. Release the trigger and correct any leaks if needed. Otherwise begin blasting the workpiece.

WARNING! Do not aim the nozzle at your fingers or the Blast Gloves. If Gloves are punctured or your feel air blowing in the Glove, replace them immediately. Do not use a damaged or punctured Glove.

13. If the tool requires more force to accomplish the task, verify that the tool receives sufficient, unobstructed airflow (CFM) and increase the pressure (PSI) output of the regulator up to the maximum air pressure rating of this tool.

CAUTION! TO PREVENT INJURY FROM TOOL OR ACCESSORY FAILURE:

Do not exceed the tool's maximum air pressure rating.

If the tool still does not have sufficient force at maximum pressure and sufficient airflow, then a larger tool may be required.

14. When finished, or to check the progress of your blasting,
 - a. Release the trigger, lay the workpiece on the floor of the Cabinet and remove your hands from the gloves.
 - b. Turn off the compressor and dust collection system (if equipped). Wait for the air inside the Cabinet to clear.
 - c. Open the Cabinet door and remove the workpiece. If the workpiece needs more blasting, resume from step 4 of these operating instructions.
15. To prevent accidents, release the trigger, detach the air supply, then squeeze and release the trigger once more to safely discharge any residual air pressure in the tool. Empty the Funnel of blast media (see User-Maintenance Instructions section). Clean external surfaces of the tool with clean, dry cloth, and apply a thin coat of tool oil. Then store the tool indoors out of children's reach.

User-Maintenance Instructions



Procedures not specifically explained in this manual must be performed only by a qualified technician.

⚠️ WARNING

TO PREVENT SERIOUS INJURY FROM ACCIDENTAL OPERATION:

Turn off the tool, detach the air supply, safely discharge any residual air pressure in the tool, and release the throttle and/or turn the switch to its off position before performing any inspection, maintenance, or cleaning procedures.

TO PREVENT SERIOUS INJURY FROM TOOL FAILURE:

Do not use damaged equipment. If abnormal noise, vibration, or leaking air occurs, have the problem corrected before further use.

Cleaning, Maintenance, and Lubrication

Note: These procedures are in addition to the regular checks and maintenance explained as part of the regular operation of the air-operated tool.

1. **Daily - Air Supply Maintenance:**

Every day, maintain the air supply according to the component manufacturers' instructions. Drain the moisture filter regularly. Performing routine air supply maintenance will allow the tool to operate more safely and will also reduce wear on the tool.

2. After use, empty the Cabinet Funnel of blast media:

CAUTION! Wear ANSI-approved Safety Goggles and NIOSH-approved dust mask/respirator when emptying the abrasive media.

- a. Place a container (sold separately), which is large enough to hold all the blast media, under the mouth of the Funnel.
- b. Turn the handle on the Funnel Mouth to open the Funnel and allow all the abrasive media to flow into the container.
- c. Close the Funnel Mouth.

Troubleshooting

Problem	Possible Causes	Likely Solutions
Decreased output.	<ol style="list-style-type: none"> 1. Not enough air pressure and/ or air flow. 2. Obstructed trigger. 3. Blocked air inlet screen (if equipped). 4. Air leaking from loose housing. 5. Mechanism contaminated. 6. Vane wear or damage. 7. Abrasive media level too low. 	<ol style="list-style-type: none"> 1. Check for loose connections and make sure that air supply is providing enough air flow (CFM) at required pressure (PSI) to the tool's air inlet. Do not exceed maximum air pressure. 2. Clean around trigger to ensure free movement. 3. Clean air inlet screen of buildup. 4. Make sure housing is properly assembled and tight. 5. Have qualified technician clean and lubricate mechanism. Install in-line filter in air supply as stated in Setup: Air Supply. 6. Replace all vanes. 7. Add more abrasive media to the Funnel.
Housing heats during use.	<ol style="list-style-type: none"> 1. Incorrect lubrication or not enough lubrication. 2. Worn parts. 	<ol style="list-style-type: none"> 1. Lubricate using air tool oil and grease according to directions. 2. Have qualified technician inspect internal mechanism and replace parts as needed.
Severe air leakage. (Slight air leakage is normal, especially on older tools.)	<ol style="list-style-type: none"> 1. Cross-threaded housing components. 2. Loose housing. 3. Damaged valve or housing. 4. Dirty, worn or damaged valve. 	<ol style="list-style-type: none"> 1. Check for incorrect alignment and uneven gaps. If cross-threaded, disassemble and replace damaged parts before use. 2. Tighten housing assembly. If housing cannot tighten properly, internal parts may be misaligned. 3. Replace damaged components. 4. Clean or replace valve assembly.
Abrasive media not effective	Abrasive media has become worn down from use.	Replace abrasive media.
Abrasive media does not fire from Abrasive Gun	<ol style="list-style-type: none"> 1. Abrasive media size is too large for Nozzle. 2. Abrasive media too moist and is sticking together. 	<ol style="list-style-type: none"> 1. Replace Nozzle with a nozzle large enough to handle abrasive media size or use finer media. 2. Replace media with dry, fresh media. Incorporate an air drier on the air supply.
Light inside Cabinet does not work	<ol style="list-style-type: none"> 1. Bulb is burned out. 2. Power cord is not plugged in. 3. Switch is off. 4. Outlet is non-functioning. 	<ol style="list-style-type: none"> 1. Replace light bulb. 2. Check that the power cord is properly plugged into an outlet. 3. Turn the Light Power Switch on. 4. Have electrical outlet serviced by a qualified electrician.



Follow all safety precautions whenever diagnosing or servicing the tool. Disconnect air supply before service.

CENTRAL PNEUMATIC®

Parts List and Diagram

PLEASE READ THE FOLLOWING CAREFULLY

THE MANUFACTURER AND/OR DISTRIBUTOR HAS PROVIDED THE PARTS LIST AND ASSEMBLY DIAGRAM IN THIS MANUAL AS A REFERENCE TOOL ONLY. NEITHER THE MANUFACTURER OR DISTRIBUTOR MAKES ANY REPRESENTATION OR WARRANTY OF ANY KIND TO THE BUYER THAT HE OR SHE IS QUALIFIED TO MAKE ANY REPAIRS TO THE PRODUCT, OR THAT HE OR SHE IS QUALIFIED TO REPLACE ANY PARTS OF THE PRODUCT. IN FACT, THE MANUFACTURER AND/OR DISTRIBUTOR EXPRESSLY STATES THAT ALL REPAIRS AND PARTS REPLACEMENTS SHOULD BE UNDERTAKEN BY CERTIFIED AND LICENSED TECHNICIANS, AND NOT BY THE BUYER. THE BUYER ASSUMES ALL RISK AND LIABILITY ARISING OUT OF HIS OR HER REPAIRS TO THE ORIGINAL PRODUCT OR REPLACEMENT PARTS THERETO, OR ARISING OUT OF HIS OR HER INSTALLATION OF REPLACEMENT PARTS THERETO.

Parts List

Part	Description	Qty
1	Frame	1
2	Glass	1
3	Glass Board	1
4	Sealing Strip	1
5	Sealing Strip	2
6	Steel Screen	1
7	Screen Frame with Foam Gasket	1
8	Cabinet Funnel	1
9	Abrasive Suction Pipe	1
10	Abrasive Removal Cover	1
11	Cover Lock	1
12	Shelf	1
13	Legs	4
14	Plastic Door	1
15	Hinge	1
16	Intake Vent Cover	1
17	Light Clamp	1
18	Sealed Ribbon	1
19	Lighting Protection film	1
20	Glass Window	1
21	Suction Flange	1
22	Hose Inlet Fitting	1
23	Latch	1
24	Metal Liner	1
25	Abrasive Gun	1

Part	Description	Qty
26	Suction Hose	1
27	Glove Mounting Ring	2
28	Glove Clamp	2
29	Gloves (Pair)	1
30	Feet	4
31a	Long Bolts M6 X 24 Screws, Nuts, Washers	14 sets
31b	Short Bolts M6 X 12 Screws, Nuts, Washers	36 sets
32	Light	2
33	Intake Vent	1
34	Intake Cover	1
35	Lightening Switch	1
36	Ceramic Nozzle*	4
37	Nozzle Cover Nut	1
42	Air Intake Connector	2
43	Hose Clamp	2
44	Air Inlet Hose	1
45	Flat Gasket	2
46	Hose Clamp	1
47	Glove Holder Clamp	1
48	Cabinet	1
49	Protective Film	1
50	Lighting Housing	1
51	Electric Cord and Plug	1

* Includes 4, 5, 6 and 7 mm Nozzles.

Record Product's Serial Number Here: _____

Note: If product has no serial number, record month and year of purchase instead.

Note: Some parts are listed and shown for illustration purposes only, and are not available individually as replacement parts.

Part	Description	Qty
1	Frame	1
2	Glass	1
3	Glass Board	1
4	Sealing Strip	1
5	Sealing Strip	2
6	Steel Screen	1
7	Screen Frame with Foam Gasket	1
8	Cabinet Funnel	1
9	Abrasive Suction Pipe	1
10	Abrasive Removal Cover	1
11	Cover Lock	1
12	Shelf	1
13	Legs	4
14	Plastic Door	1
15	Hinge	1
16	Intake Vent Cover	1
17	Light Clamp	1
18	Sealed Ribbon	1
19	Lighting Protection film	1
20	Glass Window	1
21	Suction Flange	1
22	Hose Inlet Fitting	1
23	Latch	1
24	Metal Liner	1

Part	Description	Qty
25	Abrasive Gun	1
26	Suction Hose	1
27	Glove Mounting Ring	2
28	Glove Clamp	2
29	Gloves (Pair)	1
30	Feet	4
31a	Long Bolts M6 X 24	14
31b	Short Bolts M6 X 12	36
32	Light	2
33	Intake Vent	1
34	Intake Cover	1
35	Lightening Switch	1
36	Ceramic Nozzle*	4
37	Nozzle Cover Nut	1
42	Air Intake Connector	2
43	Hose Clamp	2
44	Air Inlet Hose	1
45	Flat Gasket	2
46	Hose Clamp	1
47	Glove Holder Clamp	1
48	Cabinet	1
49	Protective Film	1
50	Lighting Housing	1
51	Electric Cord and Plug	1

* Includes 4, 5, 6 and 7 mm Nozzles.

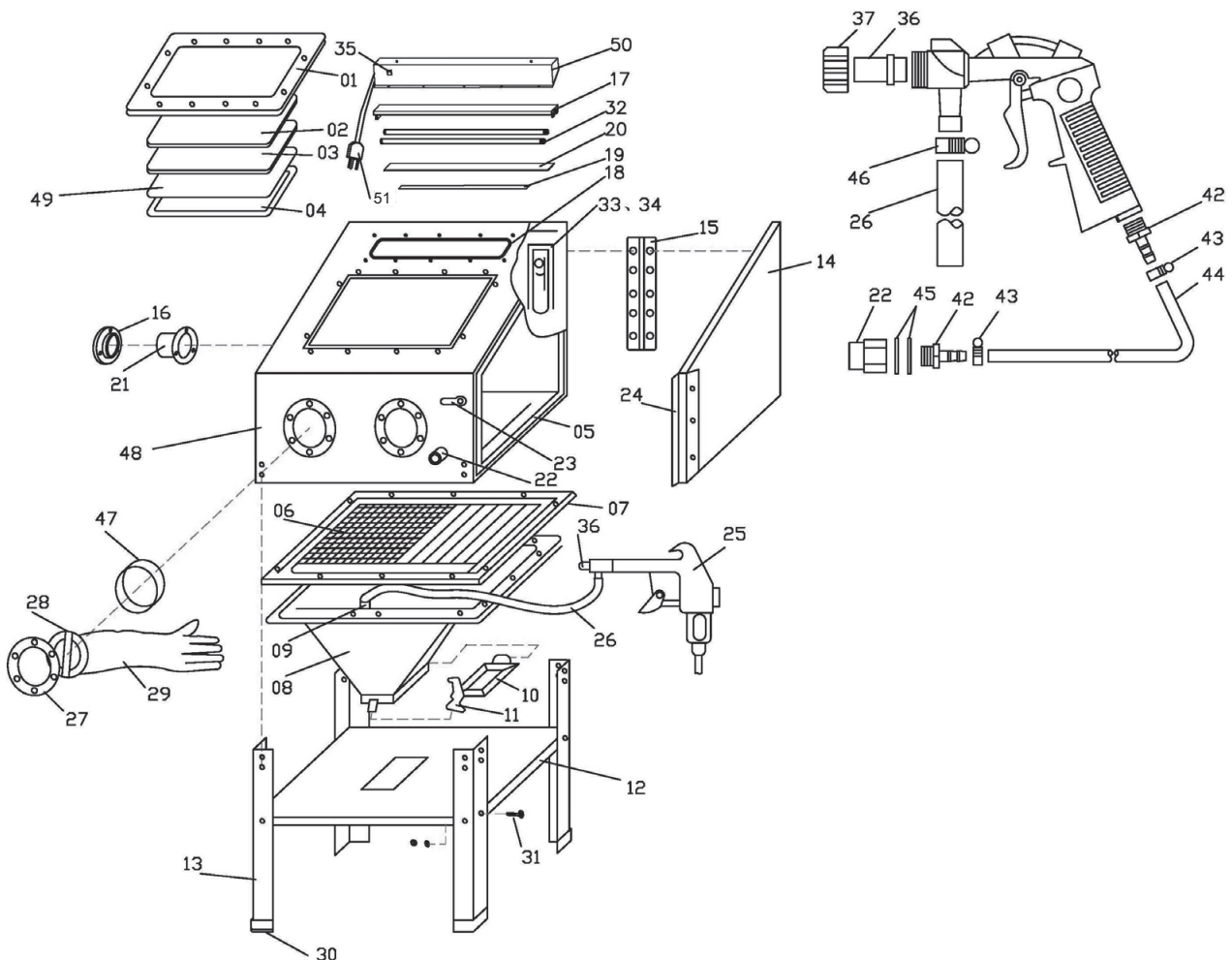

90 Day Warranty

Harbor Freight Tools Co. makes every effort to assure that its products meet high quality and durability standards, and warrants to the original purchaser that this product is free from defects in materials and workmanship for the period of 90 days from the date of purchase. This warranty does not apply to damage due directly or indirectly, to misuse, abuse, negligence or accidents, repairs or alterations outside our facilities, criminal activity, improper installation, normal wear and tear, or to lack of maintenance. We shall in no event be liable for death, injuries to persons or property, or for incidental, contingent, special or consequential damages arising from the use of our product. Some states do not allow the exclusion or limitation of incidental or consequential damages, so the above limitation of exclusion may not apply to you. THIS WARRANTY IS EXPRESSLY IN LIEU OF ALL OTHER WARRANTIES, EXPRESS OR IMPLIED, INCLUDING THE WARRANTIES OF MERCHANTABILITY AND FITNESS.

To take advantage of this warranty, the product or part must be returned to us with transportation charges prepaid. Proof of purchase date and an explanation of the complaint must accompany the merchandise. If our inspection verifies the defect, we will either repair or replace the product at our election or we may elect to refund the purchase price if we cannot readily and quickly provide you with a replacement. We will return repaired products at our expense, but if we determine there is no defect, or that the defect resulted from causes not within the scope of our warranty, then you must bear the cost of returning the product.

This warranty gives you specific legal rights and you may also have other rights which vary from state to state.

CENTRALPNEUMATIC®

3491 Mission Oaks Blvd. • PO Box 6009 • Camarillo, CA 93011 • (800) 444-3353