

# Owner's Manual & Safety Instructions

**Save This Manual** Keep this manual for the safety warnings and precautions, assembly, operating, inspection, maintenance and cleaning procedures. Write the product's serial number in the back of the manual near the assembly diagram (or month and year of purchase if product has no number). Keep this manual and the receipt in a safe and dry place for future reference.

19b

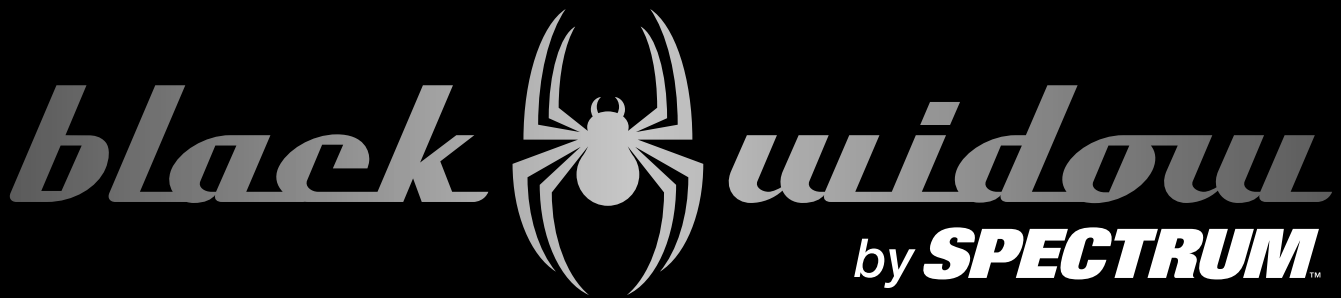

## PROFESSIONAL SPRAY GUN

56152 - 1.7mm HVLP

56153 - 1.3mm HTE



56153 Shown

### NOTICE

#### CLEAN IMMEDIATELY

Clean the Spray Gun IMMEDIATELY after EVERY use and when it will be idle for more than 30 minutes.

Delayed or inadequate cleaning will permanently clog the Spray Gun.

Visit our website at: <http://www.harborfreight.com>  
Email our technical support at: [productsupport@harborfreight.com](mailto:productsupport@harborfreight.com)

When unpacking, make sure that the product is intact and undamaged. If any parts are missing or broken, please call 1-888-866-5797 as soon as possible.

Copyright© 2019 by Harbor Freight Tools®. All rights reserved.  
No portion of this manual or any artwork contained herein may be reproduced in any shape or form without the express written consent of Harbor Freight Tools. Diagrams within this manual may not be drawn proportionally. Due to continuing improvements, actual product may differ slightly from the product described herein.  
Tools required for assembly and service may not be included.

### ⚠ WARNING

Read this material before using this product. Failure to do so can result in serious injury. SAVE THIS MANUAL.

## NOTICE

Clean the Spray Gun and Cup IMMEDIATELY after EVERY use and when it will be idle for more than 30 minutes. Delayed or inadequate cleaning will permanently clog the Spray Gun.  
**DO NOT USE LATEX PAINT IN THIS SPRAY GUN.**

## Table of Contents

|                      |   |                              |    |
|----------------------|---|------------------------------|----|
| Safety .....         | 2 | Maintenance .....            | 16 |
| Specifications ..... | 5 | Parts List and Diagram ..... | 19 |
| Setup .....          | 6 | Warranty .....               | 20 |
| Operation .....      | 8 |                              |    |

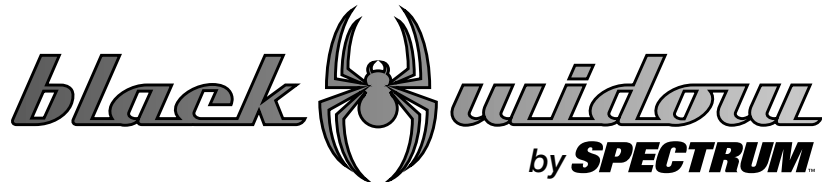

### WARNING SYMBOLS AND DEFINITIONS

|  |  |
|--|--|
|  | This is the safety alert symbol. It is used to alert you to potential personal injury hazards. Obey all safety messages that follow this symbol to avoid possible injury or death. |
|  | Indicates a hazardous situation which, if not avoided, will result in death or serious injury.   |
|  | Indicates a hazardous situation which, if not avoided, could result in death or serious injury.  |
|  | Indicates a hazardous situation which, if not avoided, could result in minor or moderate injury.   |
|  | Addresses practices not related to personal injury.  |

## IMPORTANT SAFETY INSTRUCTIONS

### INSTRUCTIONS PERTAINING TO A RISK OF FIRE, ELECTRIC SHOCK, OR INJURY TO PERSONS

The warnings and precautions discussed in this manual cannot cover all possible conditions and situations that may occur. It must be understood by the operator that common sense and caution are factors which cannot be built into this product, but must be supplied by the operator.

**WARNING** – When using tools, basic precautions should always be followed, including the following:



### Work Area

- Keep the work area clean and well lighted.** Cluttered benches and dark areas increase the risks of electric shock, fire, and injury to persons.
- Keep bystanders, children, and visitors away while operating the tool.** Distractions are able to result in the loss of control of the tool.

## NOTICE

Clean the Spray Gun and Cup **IMMEDIATELY** after **EVERY** use and when it will be idle for more than 30 minutes. Delayed or inadequate cleaning will permanently clog the Spray Gun.  
**DO NOT USE LATEX PAINT IN THIS SPRAY GUN.**

## Personal Safety

- a. **Stay alert. Watch what you are doing and use common sense when operating the tool. Do not use the tool while tired or under the influence of drugs, alcohol, or medication.** A moment of inattention while operating the tool increases the risk of injury to persons.
- b. **Dress properly. Do not wear loose clothing or jewelry. Contain long hair. Keep hair, clothing, and gloves away from moving parts.** Loose clothes, jewelry, or long hair increases the risk of injury to persons as a result of being caught in moving parts.
- c. **Do not overreach. Keep proper footing and balance at all times.** Proper footing and balance enables better control of the tool in unexpected situations.
- d.  **Use safety equipment.** Wear protective paint spraying gloves and a NIOSH-approved respirator during use. Non-skid safety shoes and a hard hat must be used for the applicable conditions.
- e.  **Always wear eye protection.** Wear ANSI-approved safety goggles.

## Tool Use and Care

- a. **Do not force the tool.** Use the correct tool for the application. The correct tool will do the job better and safer at the rate for which the tool is designed.
- b. **Disconnect the tool from the air source before making any adjustments, changing accessories, or storing the tool.** Such preventive safety measures reduce the risk of starting the tool unintentionally. Turn off and detach the air supply, safely discharge any residual air pressure, and release the throttle and/or turn the switch to its off position before leaving the work area.
- c. **Store the tool when it is idle out of reach of children and other untrained persons.** A tool is dangerous in the hands of untrained users.
- d. **Check for misalignment or binding of moving parts, breakage of parts, and any other condition that affects the tool's operation.** If damaged, have the tool serviced before using. Many accidents are caused by poorly maintained tools. There is a risk of bursting if the tool is damaged.
- e. **Use only accessories that are identified by the manufacturer for the specific tool model.** Use of an accessory not intended for use with the specific tool model, increases the risk of injury to persons.

## Service

- a. **Tool service must be performed only by qualified repair personnel.**
- b. **When servicing a tool, use only identical replacement parts. Use only authorized parts.**

## NOTICE

Clean the Spray Gun and Cup IMMEDIATELY after EVERY use and when it will be idle for more than 30 minutes. Delayed or inadequate cleaning will permanently clog the Spray Gun.  
**DO NOT USE LATEX PAINT IN THIS SPRAY GUN.**

### Air Source





- a.  **Never connect to an air source that is capable of exceeding 200 psi.**  
Over pressurizing the tool may cause bursting, abnormal operation, breakage of the tool or serious injury to persons.  
Use only clean, dry, regulated compressed air at the rated pressure or within the rated pressure range as marked on the tool. Always verify prior to using the tool that the air source has been adjusted to the rated air pressure or within the rated air-pressure range.
- b. **Never use oxygen, carbon dioxide, combustible gases or any bottled gas as an air source for the tool.** Such gases are capable of explosion and serious injury to persons.



**SAVE THESE INSTRUCTIONS.**

### Symbol Definitions

| Symbol      | Property or Statement                             |
|-------------|---|
| <b>PSI</b>  | Pounds per square inch of pressure                |
| <b>CFM</b>  | Cubic Feet per Minute flow                        |
| <b>SCFM</b> | Cubic Feet per Minute flow at standard conditions |
| <b>NPT</b>  | National pipe thread, tapered                     |
| <b>NPS</b>  | National pipe thread, straight                    |

| Symbol  | Property or Statement   |
|---|---|
|  | WARNING marking concerning Risk of Eye Injury.<br>Wear ANSI-approved eye protection.      |
|  | WARNING marking concerning Risk of Respiratory Injury.<br>Wear NIOSH-approved respirator. |
|  | WARNING marking concerning Risk of Explosion.   |
|  | WARNING marking concerning Risk of Fire.<br>Do not use solvents improperly.               |

## NOTICE

Clean the Spray Gun and Cup IMMEDIATELY after EVERY use and when it will be idle for more than 30 minutes. Delayed or inadequate cleaning will permanently clog the Spray Gun.  
**DO NOT USE LATEX PAINT IN THIS SPRAY GUN.**

### Specific Safety Instructions

1. Do not direct spray at people or animals.
2. Do not exceed maximum air pressure.
3. Do not spray near open flames, pilot lights, stoves, heaters, the air compressor, or any other heat source. Most solvents and coatings are highly flammable, particularly when sprayed. Maintain a distance of at least 25 feet from the air compressor. If possible, locate the air compressor in a separate room.
4. Read all of the information concerning coating products and cleaning solvents.  
**Do not use chlorinated solvents (e.g. 1-1-1 trichloroethylene and dichloromethane, also known as methylene chloride) to clean spray guns. Many spray guns contain aluminum, which reacts strongly to chlorinated solvents. Contact the solvent or coating manufacturer as needed regarding potential chemical reactions.**
5. RISK OF INJECTION - Do not point spray gun at any person or any part of the body. In case of skin injection, seek medical attention immediately.
6. Industrial applications must follow OSHA requirements.
7. Spraying hazardous materials may result in serious injury or death. Do not spray pesticide, acid, corrosive material, fertilizer, or toxic chemicals.
8. Paints and solvents may be harmful or fatal if swallowed or inhaled. Avoid prolonged skin contact with solvents or paints as they will irritate skin. After any contact, immediately wash off exposed area with hot, soapy water.
9. Attach all accessories properly to the tool before connecting the air supply. A loose accessory may detach or break during operation.
10. Install an in-line shutoff valve to allow immediate control over the air supply in an emergency, even if a hose is ruptured.
11. Air hose fittings may get hot during use. Allow fittings to cool before disconnecting.

### Specifications

|   | 56152                                 | 56153                                |
|---|---------------------------------------|--------------------------------------|
| Working Air Pressure (with Trigger fully depressed) | HVLP Compliant from 14 - 28 (Max) PSI | HTE Compliant from 14 - 35 (Max) PSI |
| Air Inlet   | 1/4" - 18 NPS                         | 1/4" - 18 NPS                        |
| Air Consumption                                     | 12.4 CFM @ 28 PSI                     | 11.8 CFM @ 35 PSI                    |
| Cup Capacity  | 20 oz.                                | 20 oz.                               |
| Tip Size  | 1.7mm                                 | 1.3mm                                |

## NOTICE

Clean the Spray Gun and Cup IMMEDIATELY after EVERY use and when it will be idle for more than 30 minutes. Delayed or inadequate cleaning will permanently clog the Spray Gun.  
**DO NOT USE LATEX PAINT IN THIS SPRAY GUN.**

### Initial Set Up



Read the **ENTIRE IMPORTANT SAFETY INFORMATION** section at the beginning of this manual including all text under subheadings therein before set up or use of this product.

**Note:** For additional information regarding the parts listed in the following pages, refer to the Assembly Diagram near the end of this manual.

### Before Setup

This air tool may be shipped with a protective plug covering the air inlet. Remove this plug before set up.

### Air Supply Setup

#### ⚠ WARNING



**TO PREVENT SERIOUS INJURY FROM EXPLOSION:**

Use only clean, dry, regulated, compressed air to power this tool.

Do not use oxygen, carbon dioxide, combustible gases, or any other bottled gas as a power source for this tool.

1. Incorporate a filter, regulator with pressure gauge, in-line shutoff ball valve, and quick coupler for best service, as shown on Figure A on page 7. **An in-line shutoff ball valve is an important safety device because it controls the air supply even if the air hose is ruptured. The shutoff valve should be a ball valve because it can be closed quickly.**
2. Attach an air hose to the compressor's air outlet.
3. The air hose must be long enough to reach the work area with enough extra length to allow free movement while working.
4. Turn on the air compressor according to the manufacturer's directions and allow it to build up pressure until it cycles off.
5. Adjust the air compressor's regulator so that the air output is:
  - a. 60 PSI for 56152
  - b. 70 PSI for 56153Adjust the pressure gradually, while checking the regulator, to set the right pressure.
6. Inspect the air connections for leaks. Repair any leaks found.
7. If the tool will not be used at this time, turn off the compressor.

**NOTICE:** Do not use an automatic oiler system or add oil to airline. The oil will contaminate the material being propelled, ruining the final result.

**Note:** Air flow, and therefore tool performance, can be hindered by undersized air supply components.

# NOTICE

**Clean the Spray Gun and Cup IMMEDIATELY after EVERY use and when it will be idle for more than 30 minutes. Delayed or inadequate cleaning will permanently clog the Spray Gun. DO NOT USE LATEX PAINT IN THIS SPRAY GUN.**

**Figure A: Portable Air Supply Setup**

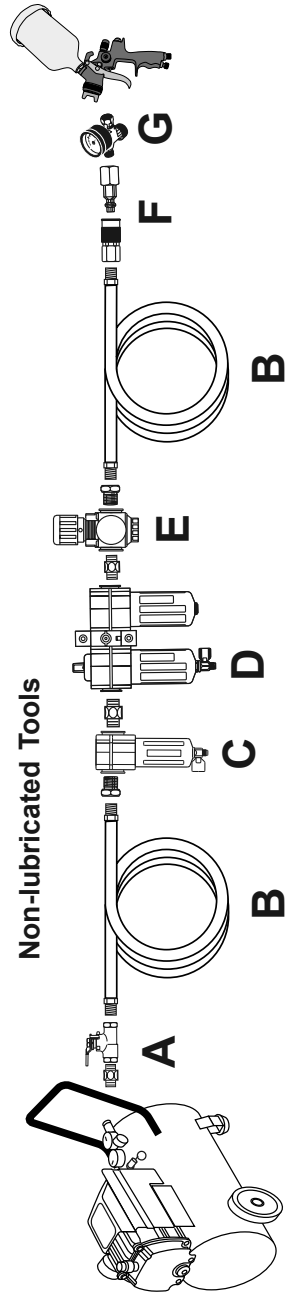

| Description            | Function   |
|------------------------|--|
| A Shutoff Ball Valve   | Isolates sections of system for maintenance                    |
| B Air Hose             | Connects air to tool   |
| D Filter               | Prevents dirt and condensation from damaging tool or workpiece |
| E Compressor Regulator | Adjusts air pressure to tool                                   |
| F Coupler and Plug*    | Provides quick connection and release                          |
| C Air Cleaner / Dryer* | Prevents water vapor from damaging workpiece                   |
| G Spray Gun Regulator  | For fine tuning airflow at tool                                |

\*Optional components.

## NOTICE

Clean the Spray Gun and Cup IMMEDIATELY after EVERY use and when it will be idle for more than 30 minutes. Delayed or inadequate cleaning will permanently clog the Spray Gun.  
**DO NOT USE LATEX PAINT IN THIS SPRAY GUN.**

### Operating Instructions



Read the ENTIRE IMPORTANT SAFETY INFORMATION section at the beginning of this manual including all text under subheadings therein before set up or use of this product.

Inspect tool before use, looking for damaged, loose, and missing parts. If any problems are found, do not use tool until repaired.

### Workpiece and Work Area Set Up

1. Designate a work area that is clean and well lit. The work area must not allow access by children or pets to prevent distraction and injury.
2. Route the air hose along a safe path to reach the work area without creating a tripping hazard or exposing the air hose to possible damage. The air hose must be long enough to reach the work area with enough extra length to allow free movement while working.
3. Before spraying, mask nearby objects not being sprayed and lay cloths (not included) on the floors.

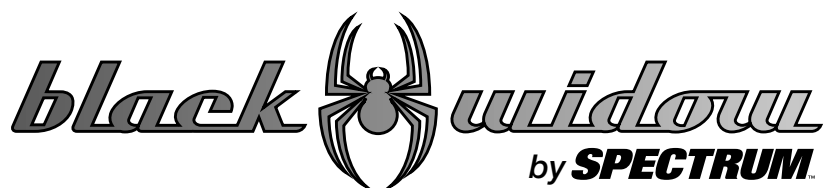



# NOTICE

Clean the Spray Gun and Cup IMMEDIATELY after EVERY use and when it will be idle for more than 30 minutes. Delayed or inadequate cleaning will permanently clog the Spray Gun. **DO NOT USE LATEX PAINT IN THIS SPRAY GUN.**

## Components and Controls

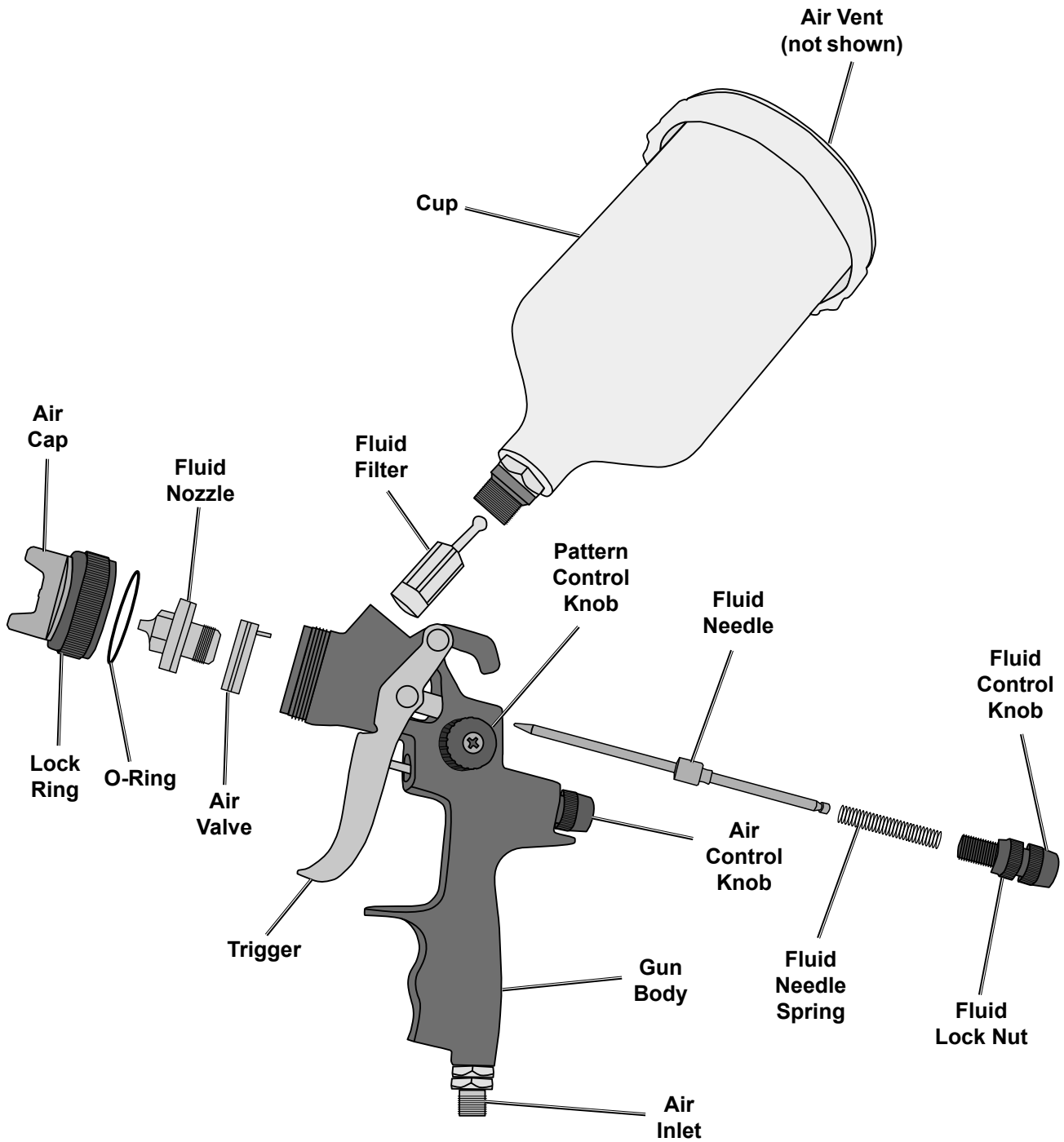

SAFETY

SETUP

OPERATION

MAINTENANCE

## NOTICE

Clean the Spray Gun and Cup IMMEDIATELY after EVERY use and when it will be idle for more than 30 minutes. Delayed or inadequate cleaning will permanently clog the Spray Gun.  
**DO NOT USE LATEX PAINT IN THIS SPRAY GUN.**

## Before First Use

**⚠ WARNING** TO PREVENT SERIOUS INJURY: Do not adjust or tamper with any control or component in a way not specifically explained within this manual. Improper adjustment can result in tool failure or other serious hazards.

**CAUTION!** To prevent injection injuries, keep hands away from Trigger while making adjustments.

**NOTICE:** Before first use, clean the Spray Gun thoroughly.

If not removed, the material used for testing and corrosion prevention will contaminate paint.

## Assembly

1. Place Fluid Filter inside Fluid Inlet.
2. Thread the Cup to the top of the Gun Body and tighten until the Cup is securely in place.
3. Pull out Air Vent to open.

**Note:** When Spray Gun is idle, push in Air Vent to close.

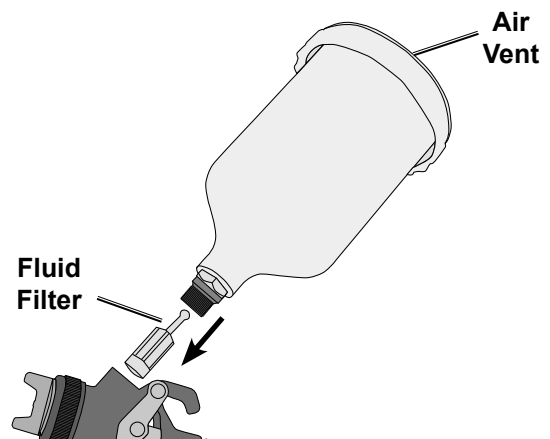

## Air Adjustment

**⚠ WARNING!** TO PREVENT SERIOUS INJURY FROM ACCIDENTAL OPERATION: Do not install a female quick coupler on the tool. Such a coupler contains an air valve that will allow the air tool to retain pressure and operate accidentally after the air supply is disconnected.

1. Attach spray gun regulator (sold separately) to Air Inlet.
2. Attach air hose to regulator.
3. Turn on air compressor according to the manufacturer's directions and allow it to build up pressure until it cycles off.
4. Adjust the air compressor's regulator so that the air output is:
  - a. 60 PSI for 56152
  - b. 70 PSI for 56153
5. Open Air Control Knob fully (counterclockwise).
6. Fully depress Trigger, then set Spray Gun's regulator to:
  - a. 28 PSI (maximum) for 56152
  - b. 35 PSI (maximum) for 56153

**Note:** If Spray Gun's regulator cannot reach maximum pressure, slowly adjust compressor's regulator until maximum pressure is achieved at the Spray Gun's regulator.

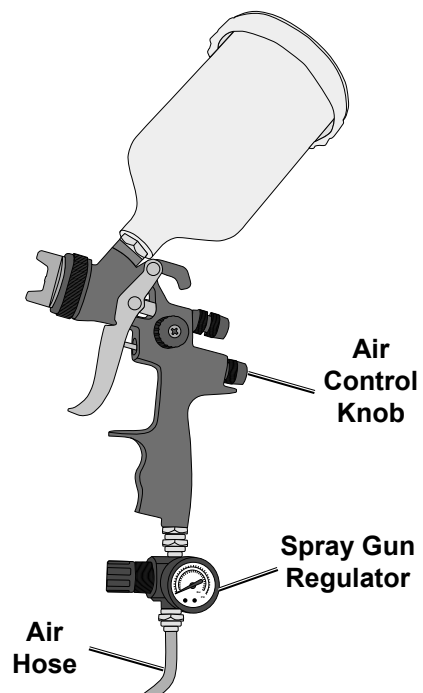

## NOTICE

Clean the Spray Gun and Cup IMMEDIATELY after EVERY use and when it will be idle for more than 30 minutes. Delayed or inadequate cleaning will permanently clog the Spray Gun. **DO NOT USE LATEX PAINT IN THIS SPRAY GUN.**

### Pre-Cleaning



**WARNING! TO PREVENT FIRE, IF A FLAMMABLE SOLVENT NEEDS TO BE USED, ADHERE TO THE FOLLOWING:**

- Follow solvent manufacturer's clean up instructions and safety precautions.
- Flush Spray Gun a full hose length from air compressor.
- If collecting flushed solvents in metal container, transfer to nonmetal container, and flush metal container.
- Work far away from any ignition sources in a vapor free area.
- Keep class ABC fire extinguisher nearby.

**NOTICE:** Do not immerse Spray Gun Body in solvent. Do not allow solvent to enter the air inlet.

- Designate a container for spent solvent.
- Remove Cup's Lid and add 2 - 4 ounces of solvent-based cleaner (sold separately).
- Replace Lid and pull out Air Vent to open.
- Open Fluid Control Knob and Fluid Lock Nut (counterclockwise) until four threads are showing. Turn Fluid Lock Nut clockwise until it stops against the Spray Gun body.
- Open Air Control Knob fully.
- After disconnecting, point the Spray Gun into the spent solvent container and depress the Trigger again to make sure no air remains.
- Remove Regulator.
- Remove Cup and Lid and allow to dry.
- Turn Lock Ring counterclockwise by hand to remove Air Cap and allow to dry.
- Depress Trigger to open passageway, then blow clean compressed air into the Fluid Inlet.

**Note:** When Spray Gun is idle, push in Air Vent to close.

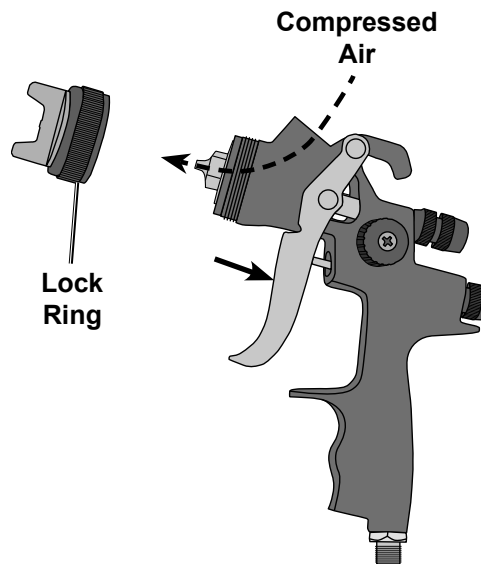
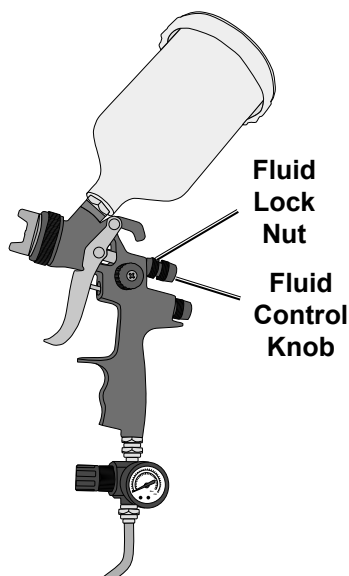

- Point Spray Gun at interior side of spent solvent container. Depress Trigger and slightly shake Spray Gun while spraying solvent into the container.
- Disconnect Spray Gun from the air source.

13. Reassemble Spray Gun.

**NOTICE:** Do not use any kind of lubricant in air supply or air inlet. The lubricant will mix with paint, causing poor results.

### Spent solvent disposal

After cleaning, dispose of spent solvent according to the solvent manufacturer's directions and local hazardous waste standards.

## NOTICE

Clean the Spray Gun and Cup IMMEDIATELY after EVERY use and when it will be idle for more than 30 minutes. Delayed or inadequate cleaning will permanently clog the Spray Gun.  
**DO NOT USE LATEX PAINT IN THIS SPRAY GUN.**

## Spray Gun Setup and Adjustment

### ⚠️ WARNING

**TO PREVENT SERIOUS INJURY:** Do not adjust or tamper with any control or component in a way not specifically explained within this manual. Improper adjustment can result in tool failure or other serious hazards.

### Paint Preparation and Filling

**NOTICE:** This Spray Gun can only be used for spraying thin waterborne and solvent-based paints. **DO NOT USE LATEX PAINT!**

**Note:** Proper paint mixture is essential. Follow the paint manufacturer's directions for thinning.

Most paints will spray easily if they are thinned properly.

1. Thin the paint according to manufacturer's directions and mix thoroughly.
2. Place Spray Gun in stand (sold separately).
3. Remove Cup's Lid.
4. Carefully strain the paint into the Cup through a paint strainer or a piece of cheesecloth.

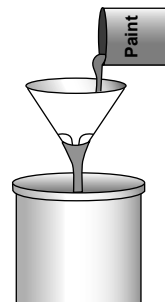

5. Fill the Cup 3/4 full.
6. Replace Lid and pull out Air Vent to open.

**Note:** When Spray Gun is idle, push in Air Vent to close.

### Fan Pattern

1. To change fan pattern:
  - a. Loosen the Lock Ring by hand until Air Cap moves freely in clockwise direction.
  - b. Turn Air Cap clockwise until proper fan pattern is achieved.

**Note:** If air escapes from Air Cap, tighten Lock Ring until no air escapes.

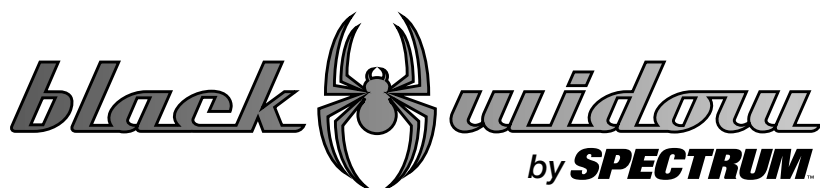
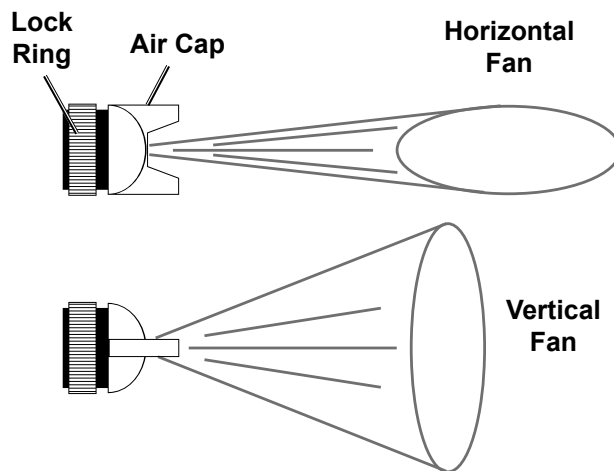

## NOTICE

Clean the Spray Gun and Cup IMMEDIATELY after EVERY use and when it will be idle for more than 30 minutes. Delayed or inadequate cleaning will permanently clog the Spray Gun.  
**DO NOT USE LATEX PAINT IN THIS SPRAY GUN.**

### Pattern Adjustment

Turn Pattern Control Knob counterclockwise (all the way open) for flat spray pattern.  
Turn Pattern Knob clockwise (all the way closed) for a round spray pattern.

**Note:** When reducing pattern size for specific areas, close the Air Control Knob a small amount at a time. until proper pattern size is achieved.

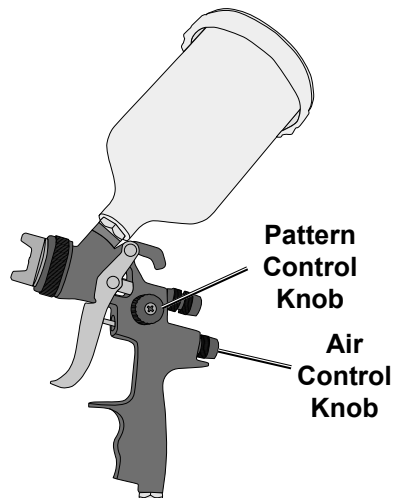
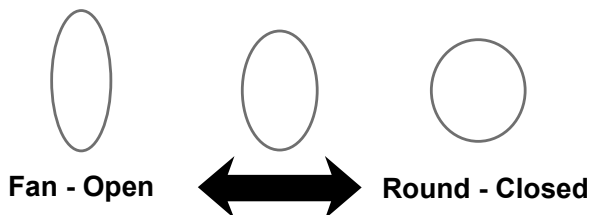

### Fluid/Air Adjustment

1. Attach spray gun regulator to Air Inlet.
2. Attach air hose to regulator.
3. Turn on air compressor according to the manufacturer's directions and allow it to build up pressure until it cycles off.
4. Adjust the air compressor's regulator so that the air output is:
  - a. 60 PSI for 56152
  - b. 70 PSI for 56153
5. Open Air Control Knob fully (counterclockwise).
6. Fully depress Trigger, then set Spray Gun's regulator to:
  - a. 28 PSI (maximum) for 56152
  - b. 35 PSI (maximum) for 56153
7. Open Fluid Control Knob (counterclockwise) until Trigger can be fully depressed.
8. Turn Fluid Lock Nut clockwise until it stops against the Spray Gun body.
9. Spray on piece of scrap material in short bursts, then check consistency.
10. If necessary, slowly close Fluid Control Knob and/or Air Control Knob (clockwise), then spray on scrap material until desired consistency is achieved.
11. To lock fluid adjustment Turn Fluid Lock Nut clockwise until it stops against the Spray Gun.
12. If paint is too thick, thin paint according to manufacturer's instructions and repeat instructions above.

**Note:** If Spray Gun's regulator cannot reach maximum pressure, slowly adjust compressor's regulator until maximum pressure is achieved at the Spray Gun's regulator

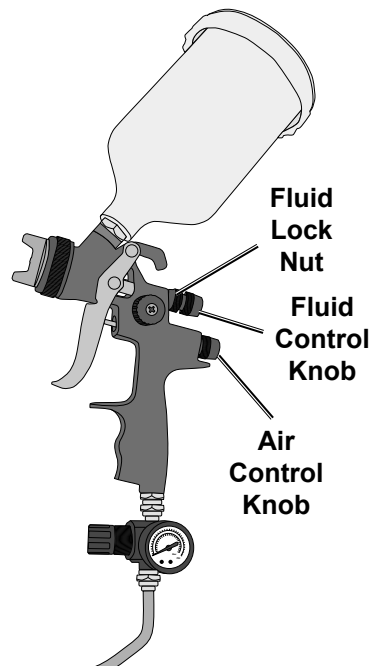

## NOTICE

Clean the Spray Gun and Cup IMMEDIATELY after EVERY use and when it will be idle for more than 30 minutes. Delayed or inadequate cleaning will permanently clog the Spray Gun.  
**DO NOT USE LATEX PAINT IN THIS SPRAY GUN.**

## Spraying Technique

**IMPORTANT:** Proper spraying technique is ESSENTIAL to achieve good results.

1. First, clean and prepare the Spray Gun according to the instructions under **Before First Use on page 10 and Spray Gun Setup and Adjustment on page 1212.**
2. Keep the Spray Gun upright and at a right angle to the workpiece - **See Figure B and Figure C.**

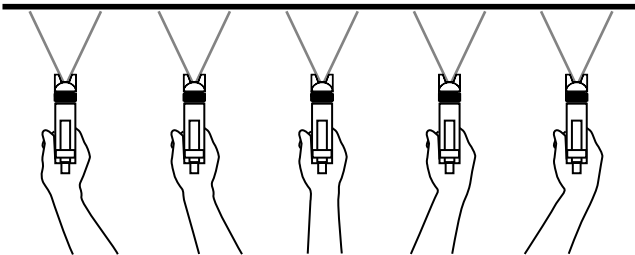

### Correct Gun Angle

Move your arm, not just your wrist.  
Point gun directly towards the surface and maintain an even, steady distance and speed.

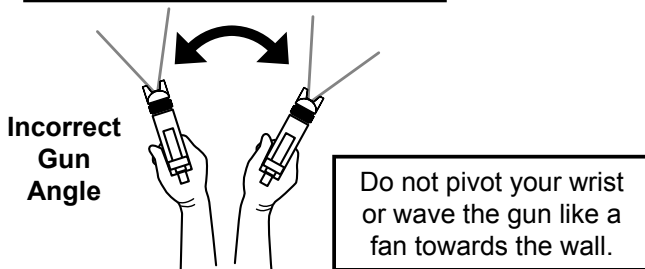

Figure B: Spray Gun Angle - top view

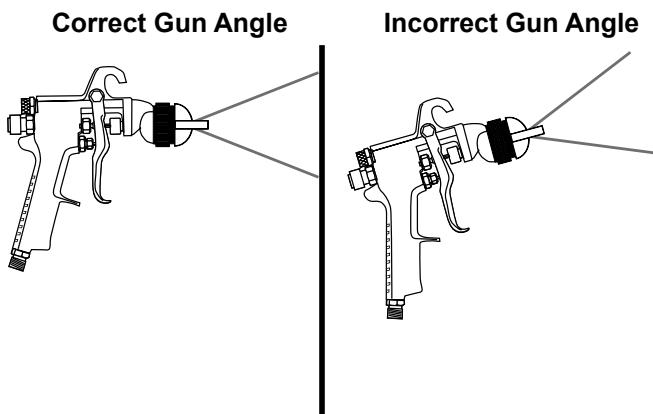

Figure C: Spray Gun Angle - side view:

**NOTICE: DO NOT STOP WHEN SPRAYING.**  
Spraying materials will start to set and dry as soon as they come in contact with the air.

3. Depress Trigger fully and move Spray Gun in parallel strokes to the workpiece.
4. Keep the distance from the workpiece:
  - a. 6" for 56152
  - b. 7" for 56153
5. To avoid paint build up:
  - a. Apply two thin coats rather than one thick coat. Overlap 1/3 to 1/2 on second coat.
  - b. Start moving the Spray Gun before fully depressing Trigger.
  - c. Fully depress Trigger before contacting the workpiece.
  - d. When finished with the stroke, release the Trigger while still moving the Spray Gun and after passing the workpiece - see Figure D.

**Note:** Doing this will produce a smoother finish. Do not stop moving the Spray Gun while spraying. If the Spray Gun stops even briefly while spraying the paint will build up and run down the workpiece.

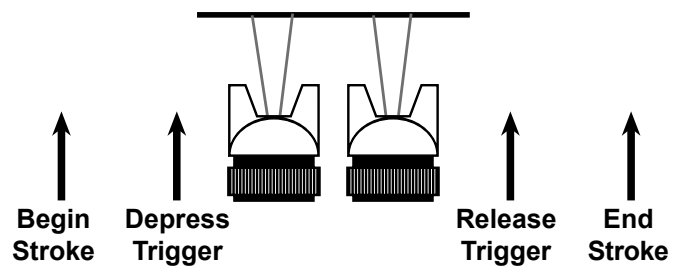

Figure D: Paint Stroke Triggering - top view

**Note:** The stroke speed and Fluid Control Knob adjustment, will determine how much paint is being applied.

**CAUTION!** Air hose fittings may get hot. Allow fittings to cool before disconnecting, or wear gloves to prevent burns.

6. To prevent accidents, after use, release Trigger, detach air supply, safely discharge any residual air pressure, and release Trigger again.
7. **Clean the Spray Gun and Cup IMMEDIATELY after EVERY use and when it will be idle for more than 30 minutes. Delayed or inadequate cleaning will permanently clog the Spray Gun. See Post-Cleaning on page 15.**

## NOTICE

Clean the Spray Gun and Cup IMMEDIATELY after EVERY use and when it will be idle for more than 30 minutes. Delayed or inadequate cleaning will permanently clog the Spray Gun. **DO NOT USE LATEX PAINT IN THIS SPRAY GUN.**

## After Every Use



**WARNING! TO PREVENT FIRE, IF A FLAMMABLE SOLVENT NEEDS TO BE USED, ADHERE TO THE FOLLOWING:**

- a. Follow solvent manufacturer's clean up instructions and safety precautions.
- b. Flush Spray Gun a full hose length from air compressor.
- c. If collecting flushed solvents in metal container, transfer to nonmetal container, and flush metal container.
- d. Work far away from any ignition sources in a vapor free area.
- e. Keep class ABC fire extinguisher nearby.

### Solvent Selection

Follow the paint and solvent manufacturer's recommendations for cleaning, solvent type, and disposal.

### Post-Cleaning

**NOTICE: Do not immerse Spray Gun Body in solvent. Do not allow solvent to enter the air inlet.**

1. Use solvent recommended by paint manufacturer.
2. Designate a container for spent solvent.
3. Remove Cup's Lid. Carefully scrape paint out of Cup and dispose of excess paint properly.
4. Add 1/4 cup of solvent (sold separately) to Cup. Replace Lid and Close Air Vent, then shake Spray Gun for several seconds.
5. Remove Lid, pour solvent into spent solvent container and wipe away any paint residue from Cup and Lid with clean cloth.
6. Add 1/4 cup of solvent to Cup. Replace Lid and pull out Air Vent to open.
7. Open Fluid Control Knob and Fluid Lock Nut (counterclockwise) until four threads are showing. Turn Fluid Control Knob Lock clockwise until it stops against the Spray Gun body.
8. Open Air Control Knob fully.
9. Point Spray Gun at interior side of spent solvent container. Depress Trigger and slightly shake Spray Gun while spraying solvent into the container. Once the Cup is empty, repeat the process until the solvent comes out clean.
10. Disconnect Spray Gun from the air source.
11. After disconnecting, point the Spray Gun into the spent solvent container and depress the Trigger again to make sure no air remains.
12. Remove Regulator and Cup.

13. Remove Air Cap and O-Ring. Depress Trigger to retract Fluid Needle, then remove Fluid Nozzle with included wrench.
14. Remove Air Valve.
15. Remove Fluid Control Knob, Fluid Needle Spring, and Fluid Needle.

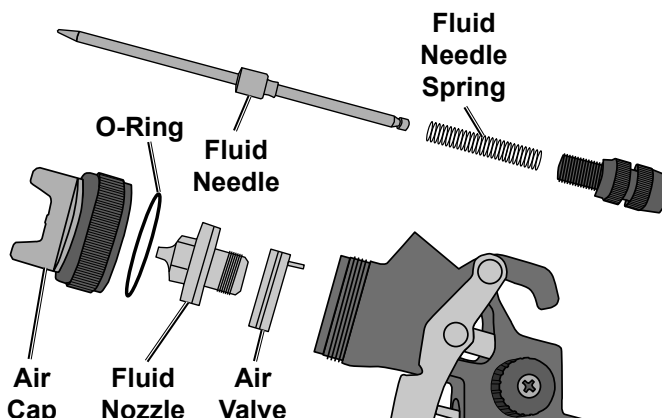

16. Inspect parts and soak in solvent as necessary. Use brushes and toothpicks (sold separately) to remove any paint.
17. Wipe down Spray Gun Body with a clean cloth and solvent.
18. Make sure all parts are dry and free from residual paint, then reassemble Spray Gun. Make sure Air Valve's pin slides into top hole.

**Note: To prevent damage, do not use metal objects to clean parts. Do not bend Fluid Needle.**

**NOTICE: Do not use any kind of lubricant in air supply or air inlet. The lubricant will mix with paint, causing poor results.**

### Spent Solvent Disposal

After cleaning, dispose of spent solvent according to the solvent manufacturer's directions and local hazardous waste standards.

## NOTICE

Clean the Spray Gun and Cup IMMEDIATELY after EVERY use and when it will be idle for more than 30 minutes. Delayed or inadequate cleaning will permanently clog the Spray Gun.  
**DO NOT USE LATEX PAINT IN THIS SPRAY GUN.**

### User-Maintenance Instructions



Procedures not specifically explained in this manual must be performed only by a qualified technician.

### WARNING

#### TO PREVENT SERIOUS INJURY:

Detach the air supply and safely discharge any residual air pressure in the tool before performing any inspection, maintenance, or cleaning procedures.

#### TO PREVENT SERIOUS INJURY FROM TOOL FAILURE: Do not use damaged equipment.

If abnormal noise, vibration, or leaking air occurs, have the problem corrected before further use.

## Inspection

**Note:** These procedures are in addition to the regular checks and maintenance explained as part of the regular operation of the air-operated tool.

**BEFORE EACH USE**, inspect the general condition of the tool. Check for:

- loose screws,
- misalignment or binding of moving parts,
- clogged air cap or fluid nozzle,
- damaged air supply hose,
- cracked or broken parts, and
- any other condition that may affect its safe operation.

## Air Supply Maintenance

Every day, perform maintenance on the air supply according to the component manufacturers' instructions.

## Storage

Open Fluid Control Knob and store in a dry, secure area out of reach of children.







## NOTICE

**Clean the Spray Gun and Cup IMMEDIATELY after EVERY use and when it will be idle for more than 30 minutes. Delayed or inadequate cleaning will permanently clog the Spray Gun. DO NOT USE LATEX PAINT IN THIS SPRAY GUN.**

## Troubleshooting - Spray Pattern Diagnosis

**Note:** The drawings on the left below resemble symptoms of spray pattern problems. Refer to the accompanying possible causes and likely solutions to the right.

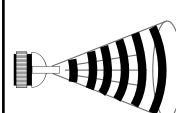
| Problem  | Possible Causes  | Likely Solutions   |
|--|--|--|
| <br>Heavy center pattern              | 1. Pattern Knob partially closed.<br>2. The paint is too thick.<br>3. The air pressure is too low.           | 1. Open Pattern Knob more.<br>2. Thin paint according to the manufacturer's instructions.<br>3. Increase air pressure within the Working Air Pressure. |
| <br>Light center pattern              | 1. High air pressure.<br>2. Fluid Knob not open enough.<br>3. Pattern Knob open too far.                     | 1. Reduce air pressure.<br>2. Open Fluid Knob.<br>3. Partially close Pattern Knob.   |
| <br>Heavy top/<br>bottom pattern      | 1. Air Cap plugged.<br>2. Air Cap loose.<br>3. Dried paint on Fluid Nozzle.                                  | 1. Clean Air Cap.<br>2. Clean and tighten Air Cap.<br>3. Use a nonmetallic point to clean Fluid Nozzle.  |
| <br>Pattern on right<br>or left only | 1. Buildup on one side of Fluid Nozzle.<br>2. Holes on one side of Air Cap are plugged.                      | 1. Use a nonmetallic point to clean Fluid Nozzle.<br>2. Use a nonmetallic point to clean Air Cap.  |
| <br>Jerky or<br>Fluttering Spray     | 1. Loose or damaged Air Cap.<br>2. Paint level low.<br>3. Obstruction in Fluid Inlet.<br>4. Air Vent closed. | 1. Tighten or replace.<br>2. Refill paint Cup.<br>3. Backflush with solvent.<br>4. Open Air Vent.  |



**Follow all safety precautions whenever diagnosing or servicing the tool. Disconnect air supply before service.**

SAFETY

SETUP

OPERATION

MAINTENANCE

## NOTICE

Clean the Spray Gun and Cup IMMEDIATELY after EVERY use and when it will be idle for more than 30 minutes. Delayed or inadequate cleaning will permanently clog the Spray Gun.  
**DO NOT USE LATEX PAINT IN THIS SPRAY GUN.**

### General Troubleshooting Chart

| Problem  | Possible Causes   | Likely Solutions   |
|--|---|--|
| Sputtering Spray   | <ol style="list-style-type: none"><li>1. Low paint level.</li><li>2. Cup tipped.</li><li>3. Clogged Air Vent on Cup.</li><li>4. Loose Fluid Inlet connection.</li></ol> | <ol style="list-style-type: none"><li>1. Refill.</li><li>2. Hold upright.</li><li>3. Clean Air Vent hole.</li><li>4. Tighten Fluid Inlet connection</li></ol>            |
| Will Not Spray   | <ol style="list-style-type: none"><li>1. No pressure at Spray Gun.</li><li>2. Fluid Knob not open enough.</li><li>3. Fluid too thick.</li></ol>                         | <ol style="list-style-type: none"><li>1. Check air hoses.</li><li>2. Open Fluid Knob.</li><li>3. Thin fluid or increase air pressure. (Do not exceed maximum.)</li></ol> |
| Excess overspray<br>(Paint drifting to unintended objects.)  | <ol style="list-style-type: none"><li>1. Improper application speed.</li><li>2. Improper distance from workpiece.</li><li>3. Too much air pressure.</li></ol>           | <ol style="list-style-type: none"><li>1. Move moderately and parallel.</li><li>2. Adjust distance.</li><li>3. Reduce air pressure.</li></ol>                             |
| Fluid Nozzle Leakage   | Buildup on Fluid Nozzle.  | Use a nonmetallic point to clean Fluid Nozzle.   |
| Air Leaking from Air Cap   | Buildup on Air Valve.   | Clean Air Valve.   |
|  <b>Follow all safety precautions whenever diagnosing or servicing the tool. Disconnect air supply before service.</b> |   |  |

### PLEASE READ THE FOLLOWING CAREFULLY

THE MANUFACTURER AND/OR DISTRIBUTOR HAS PROVIDED THE PARTS LIST AND ASSEMBLY DIAGRAM IN THIS MANUAL AS A REFERENCE TOOL ONLY. NEITHER THE MANUFACTURER OR DISTRIBUTOR MAKES ANY REPRESENTATION OR WARRANTY OF ANY KIND TO THE BUYER THAT HE OR SHE IS QUALIFIED TO MAKE ANY REPAIRS TO THE PRODUCT, OR THAT HE OR SHE IS QUALIFIED TO REPLACE ANY PARTS OF THE PRODUCT. IN FACT, THE MANUFACTURER AND/OR DISTRIBUTOR EXPRESSLY STATES THAT ALL REPAIRS AND PARTS REPLACEMENTS SHOULD BE UNDERTAKEN BY CERTIFIED AND LICENSED TECHNICIANS, AND NOT BY THE BUYER. THE BUYER ASSUMES ALL RISK AND LIABILITY ARISING OUT OF HIS OR HER REPAIRS TO THE ORIGINAL PRODUCT OR REPLACEMENT PARTS THERETO, OR ARISING OUT OF HIS OR HER INSTALLATION OF REPLACEMENT PARTS THERETO.

**Record Product's Serial Number Here:** \_\_\_\_\_

**Note:** If product has no serial number, record month and year of purchase instead.

**Note:** Some parts are listed and shown for illustration purposes only, and are not available individually as replacement parts. Parts may not be interchangeable. Specify item number when ordering.

# NOTICE

**Clean the Spray Gun and Cup IMMEDIATELY after EVERY use and when it will be idle for more than 30 minutes. Delayed or inadequate cleaning will permanently clog the Spray Gun. DO NOT USE LATEX PAINT IN THIS SPRAY GUN.**

## Parts List and Diagram

| Part | Description            | Qty |
|------|------------------------|-----|
| 1    | Air Cap                | 1   |
| 1-1  | O-Ring                 | 1   |
| 2    | Fluid Nozzle           | 1   |
| 3    | Air Valve              | 1   |
| 4    | Gun Body               | 1   |
| 5    | Needle Packing         | 1   |
| 6    | Washer                 | 1   |
| 7    | Fluid Spring           | 1   |
| 8    | Needle Packing Nut     | 1   |
| 9    | Fluid Needle           | 1   |
| 10   | Fluid Needle Spring    | 1   |
| 11   | Fluid Control Knob Set | 1   |
| 12   | Air Valve Shaft        | 1   |
| 13   | Air Valve Gasket       | 1   |
| 14   | Spring                 | 1   |
| 15   | Air Control Set        | 1   |
| 16   | Screw                  | 1   |

| Part | Description             | Qty |
|------|-------------------------|-----|
| 17   | Fan Control Assembly    | 1   |
| 18   | Pattern Adjustment Knob | 1   |
| 19   | Screw                   | 1   |
| 20   | Air Inlet               | 1   |
| 21   | Pin                     | 1   |
| 22   | Hollow Pin              | 1   |
| 23   | E-Clip                  | 2   |
| 24   | Trigger                 | 1   |
| 25   | Screw                   | 1   |
| 26   | Teflon Gasket           | 1   |
| 27   | Gasket                  | 1   |
| 28   | Air Vent                | 1   |
| 29   | Lid                     | 1   |
| 30   | Cup                     | 1   |
| 31   | Fluid Filter            |     |
| 32   | Body Base Plate         | 1   |
| 33   | Screw                   | 1   |

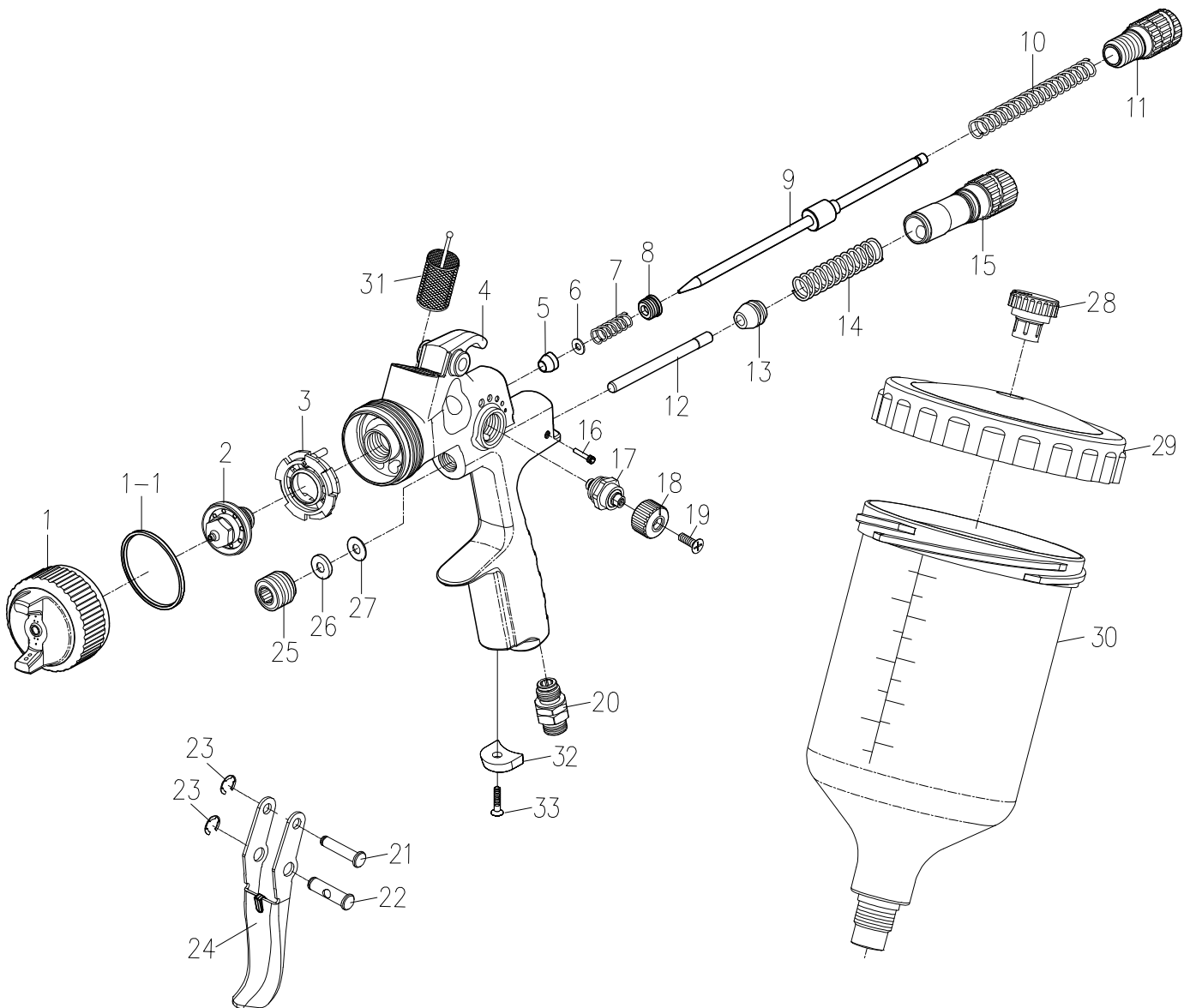

SAFETY

SETUP

OPERATION

MAINTENANCE

## Limited 90 Day Warranty

Harbor Freight Tools Co. makes every effort to assure that its products meet high quality and durability standards, and warrants to the original purchaser that this product is free from defects in materials and workmanship for the period of 90 days from the date of purchase. This warranty does not apply to damage due directly or indirectly, to misuse, abuse, negligence or accidents, repairs or alterations outside our facilities, criminal activity, improper installation, normal wear and tear, or to lack of maintenance. We shall in no event be liable for death, injuries to persons or property, or for incidental, contingent, special or consequential damages arising from the use of our product. Some states do not allow the exclusion or limitation of incidental or consequential damages, so the above limitation of exclusion may not apply to you. THIS WARRANTY IS EXPRESSLY IN LIEU OF ALL OTHER WARRANTIES, EXPRESS OR IMPLIED, INCLUDING THE WARRANTIES OF MERCHANTABILITY AND FITNESS.

To take advantage of this warranty, the product or part must be returned to us with transportation charges prepaid. Proof of purchase date and an explanation of the complaint must accompany the merchandise. If our inspection verifies the defect, we will either repair or replace the product at our election or we may elect to refund the purchase price if we cannot readily and quickly provide you with a replacement. We will return repaired products at our expense, but if we determine there is no defect, or that the defect resulted from causes not within the scope of our warranty, then you must bear the cost of returning the product.

This warranty gives you specific legal rights and you may also have other rights which vary from state to state.

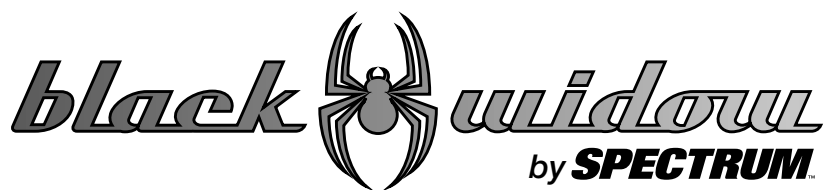

26541 Agoura Road • Calabasas, CA 91302 • 1-888-866-5797