

Owner's Manual & Safety Instructions

Save This Manual Keep this manual for the safety warnings and precautions, assembly, operating, inspection, maintenance and cleaning procedures. Write the product's serial number in the back of the manual near the assembly diagram (or month and year of purchase if product has no number). Keep this manual and the receipt in a safe and dry place for future reference.

19c

COVERPRO®

10 FT. X 10 FT. PORTABLE SHED



WARNING! Do not start or operate any internal combustion engine inside or near Shed.

Visit our website at: <http://www.harborfreight.com>
Email our technical support at: predator@harborfreight.com

56184

When unpacking, make sure that the product is intact and undamaged. If any parts are missing or broken, please call 1-888-866-5797 as soon as possible.

Copyright© 2019 by Harbor Freight Tools®. All rights reserved.
No portion of this manual or any artwork contained herein may be reproduced in any shape or form without the express written consent of Harbor Freight Tools. Diagrams within this manual may not be drawn proportionally. Due to continuing improvements, actual product may differ slightly from the product described herein.
Tools required for assembly and service may not be included.

⚠ WARNING

Read this material before using this product.
Failure to do so can result in serious injury.
SAVE THIS MANUAL.

Table of Contents

Safety	3	Maintenance	10
Specifications	4	Parts List.....	11
Assembly	4	Warranty	12



WARNING SYMBOLS AND DEFINITIONS

	This is the safety alert symbol. It is used to alert you to potential personal injury hazards. Obey all safety messages that follow this symbol to avoid possible injury or death.
	Indicates a hazardous situation which, if not avoided, will result in death or serious injury.
	Indicates a hazardous situation which, if not avoided, could result in death or serious injury.
	Indicates a hazardous situation which, if not avoided, could result in minor or moderate injury.
	Addresses practices not related to personal injury.

	WARNING marking concerning Risk of Eye Injury. Wear ANSI-approved safety goggles with side shields.
	Read the manual before assembly and/or use.
	WARNING marking concerning Risk of Head Injury. Wear hard hat during assembly and service.

	WARNING marking concerning Risk of Hand Injury. Wear heavy-duty work gloves during assembly and service.
	WARNING marking concerning Risk of Respiratory Injury. Operate engine OUTSIDE and far away from windows, doors, and vents.

IMPORTANT SAFETY INFORMATION

⚠️ WARNING

Read all safety warnings and instructions.

Failure to follow the warnings and instructions may result in serious injury.

Save all warnings and instructions for future reference.

The warnings, precautions, and instructions discussed in this instruction manual cannot cover all possible conditions and situations that may occur. It must be understood by the operator that common sense and caution are factors which cannot be built into this product, but must be supplied by the operator.

Assembly Precautions

1. Do not assemble in windy conditions.
2. Assemble and install only on flat, level, hard surface.
3. Assemble and anchor only according to these instructions. Improper assembly or inadequate anchoring can create hazards.
4. Check for utility lines, tree branches and other structures before assembling.
5. Verify that installation surface has no hidden utility lines before anchoring.
6. Wear ANSI-approved safety goggles, heavy-duty work gloves and hard hat during assembly and service.
7. Keep assembly area clean and well lit.
8. Keep bystanders out of the area during assembly.
9. Do not assemble when tired or when under the influence of drugs or medication.
10. Product capabilities apply to properly and completely assembled product only.

Use Precautions

1.  **CARBON MONOXIDE HAZARD**
Using an engine inside Shed CAN KILL YOU IN MINUTES.
Engine exhaust contains carbon monoxide. This is a poison you cannot see or smell.
NEVER use an engine inside Shed, EVEN IF cover is open.
Only use an engine OUTSIDE and far away from Shed.
2. **DO NOT USE IN HIGH WIND. Remove cover if harsh weather or heavy rain threatens.**
3. **For temporary use only. Do not use for long-term shelter.**
4. **Do not use as tent. Does not meet tent flammability standards. Do not use grill, heater, or ignition sources inside or near cover.**
5. **Do not allow snow, rainwater or debris to accumulate or pool on cover.**
6. **Do not hang objects from any part of the Shed.**
7. This product is not a toy. Do not allow children to play with or near this item.
8. Use as intended only.
9. Inspect regularly, tighten all loose hardware and loose ropes, and secure all loosened anchors. If any parts are damaged, bent, or stretched, they must be replaced. Hardware may loosen during normal operation stresses. Loose hardware or damaged/altered parts will compromise the structural integrity of this product.
10. Maintain product labels and nameplates. These carry important safety information. If unreadable or missing, contact Harbor Freight Tools for a replacement.



SAVE THESE INSTRUCTIONS.

Specifications

Overall Dimensions	10' W x 10' L
Center Height	8' 1"

Side Height	6' 3"
Tubing Diameter	1.321" Dia x 0.039" T

Assembly Instructions



Read the **ENTIRE IMPORTANT SAFETY INFORMATION** section at the beginning of this manual including all text under subheadings therein before set up or use of this product.

WARNING

TO PREVENT SERIOUS INJURY:

Do not leave this product partially assembled. Assemble this product completely at one time.

Note: At least 3 workers are required for assembly. Before starting assembly, review the instructions and make sure there is enough time and the proper tools available to properly assemble.

Finger tighten all connections until assembly is done. Assemble on a flat, level surface.

1. Gather the Bolts and put into two piles:
 - a. Bolt M6 x 40 (12) will be used to assemble the Bottom Rails (9).
 - b. Bolt M6 x 50 (13) will be used to assemble the Top Rails (2) and Rafters (1).

Assemble Roof

Note: Unless where otherwise noted, this product's assembly is done using slip fit construction. Make sure all parts seat completely and securely. A rubber mallet (sold separately) can be used to gently tap parts in place to ensure a tight fit.

1. Lay out Roof parts.

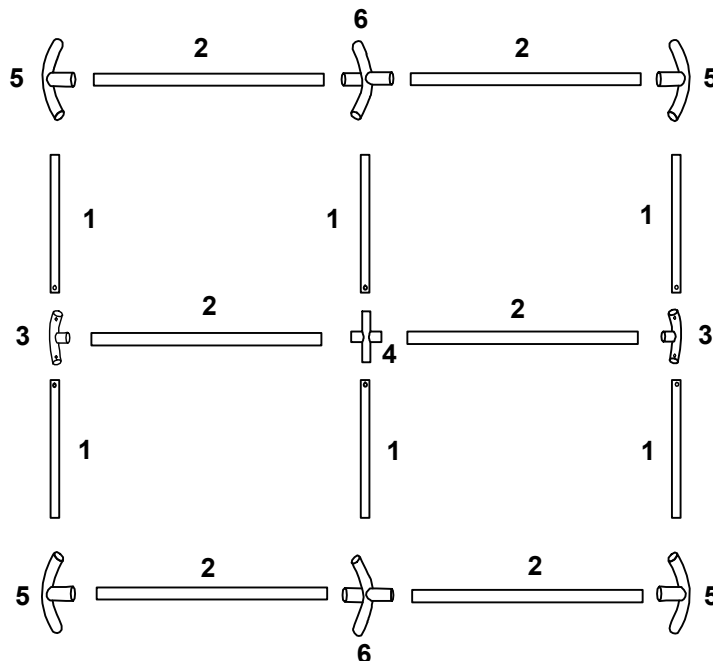

NOTICE: To prevent damage to the material, make sure all hardware is installed with Bolt facing cover and Nuts facing inside, away from cover.

2. Connect four Rafters (1) to two 3-Way Rail Connectors (3) using four Bolts (13) and Nuts (14).
3. Connect two Rafters (1) to one 4-Way Rail Connector (4) using two Bolts (13) and Nuts (14).
4. Connect two Top Rails (2) to tie the 4-Way Rail Connector assembly and two 3-Way Rail Connector assemblies together. Slide the Rails into the Connector openings and push all the way in to secure.

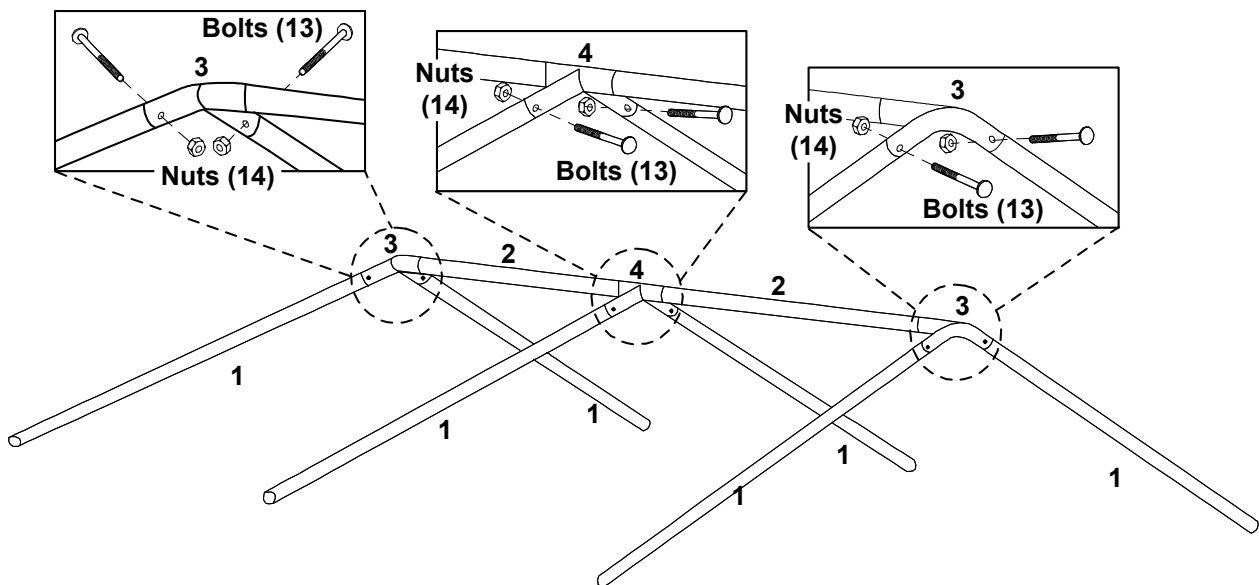

5. Connect four 3-Way Corner Connectors, one to each of the four outside corner legs.
6. Connect two 4-Way Center Connectors, one to each end of the inside center legs.
7. Using four Top Rails (2), connect one between each Corner and Center assembly, tying them together. Slide the Rails into the Connector openings and push all the way in to secure.

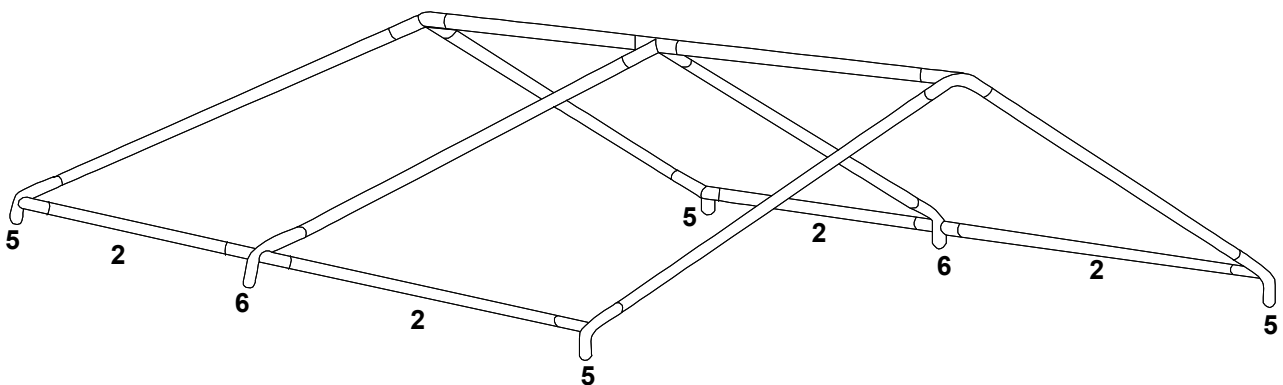

Assemble and Attach Legs

1. Attach four Corner Feet (7) to the four corner Legs (2).
2. Attach two Center Feet (8) to the two center Legs (2).

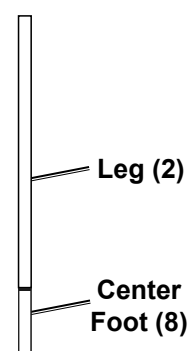
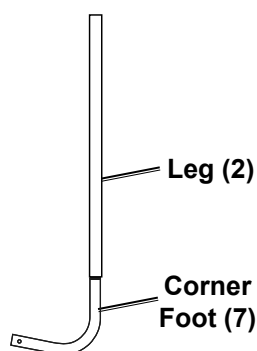

4. Attach Corner Legs and Feet to the four 3-Way Corner Connectors.

5. Attach Center Legs and Feet to the two 4-Way Center Connectors.

NOTICE: To prevent damage to the material, make sure all hardware is installed with Bolt facing cover and Nuts facing inside, away from cover.

6. Connect four Bottom Rails (9) between the Center and Corner Legs using the Center Clamps (11) and Corner Clamps (10).

a. For Center Legs: Place one Center Clamp (11) on the front and one on the back of the connection. Secure the Clamps using two Bolts (12) and Nuts (14). Tighten. Repeat for the other Center Leg.

b. For Corner Legs: Place one Corner Clamp (10) on the front and one on the back of the connection. Secure the Clamps using one Bolt (12) and Nut (14). Tighten. Repeat for the other three Corner Legs.

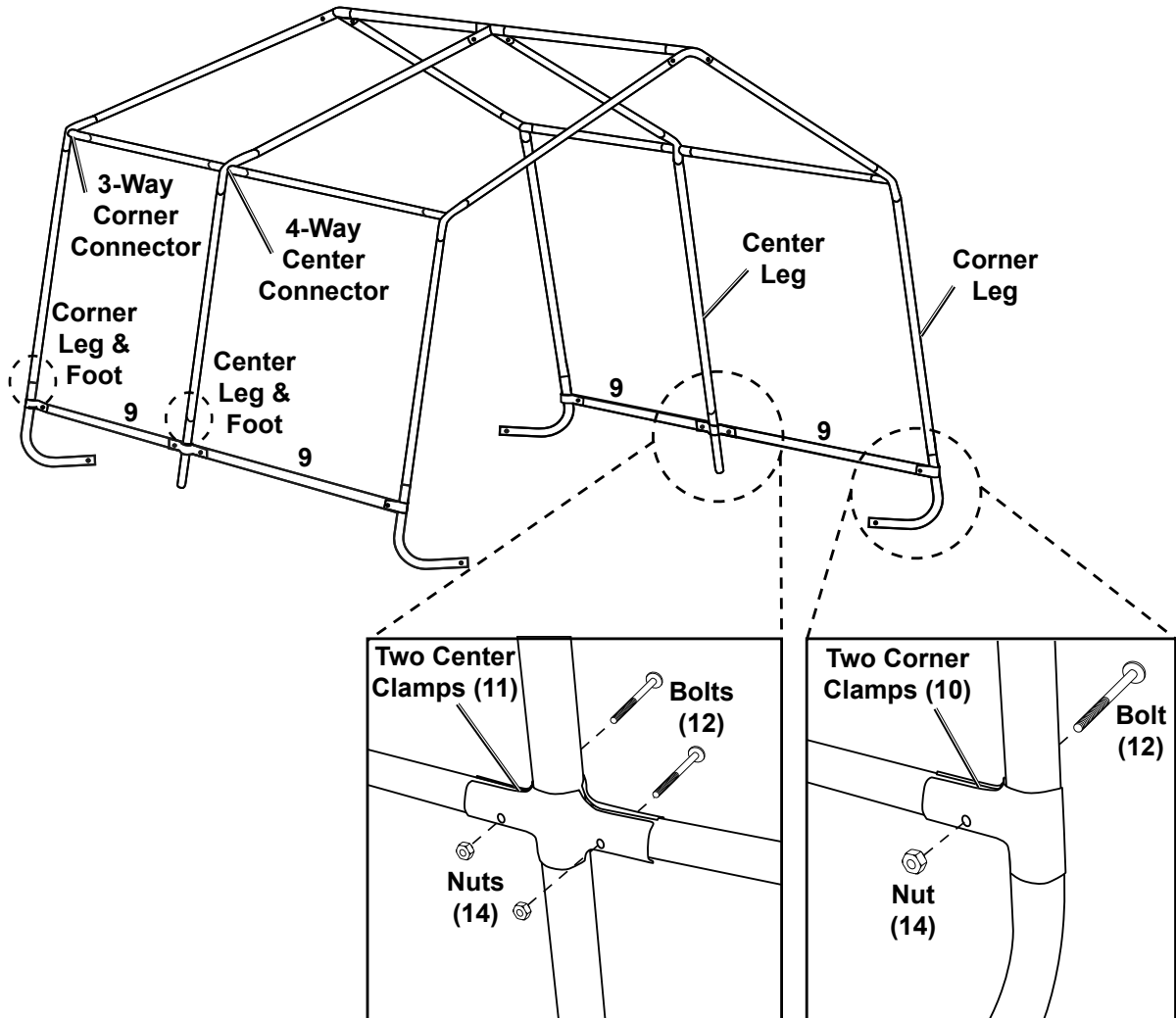

Square up the Frame

⚠️WARNING

TO PREVENT SERIOUS INJURY:

Contact local utility companies to ensure that the installation area is free of pipes, cables, and other hazards **BEFORE** choosing installation area or installing anchors.

1. Position the frame in the desired location, making sure it is level and flat.
2. Measure between diagonal corners. **These measurements must be within 1" of each other.**
3. Measure across front and back. **These measurements must be 10' each.**
4. If any measurements do not match, adjust the frame and measure again until measurements match.

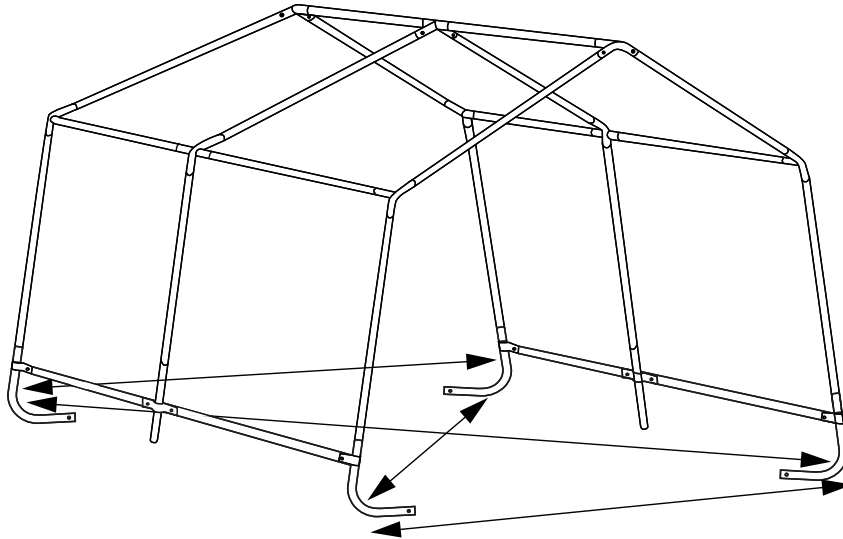

Anchor the Frame

WARNING! Anchor only according to these instructions. Improper assembly or inadequate anchoring can create hazards.

CAUTION! To prevent tripping hazard, position Anchors toward the interior of the frame, close to the Corner Feet.

1. Use a metal bar (sold separately) to thread the Anchor (16) into the ground, until the loop at the top of the Anchor extends just above the ground.
3. Tighten the Wire Rope and secure it using a Wire Rope Clamp (18). Tighten the nuts on the Clamp evenly.

Note: When anchoring to concrete, use Concrete Anchors (not included).

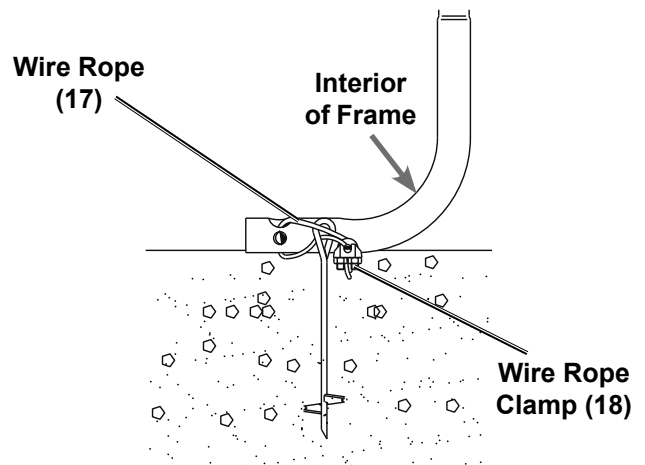
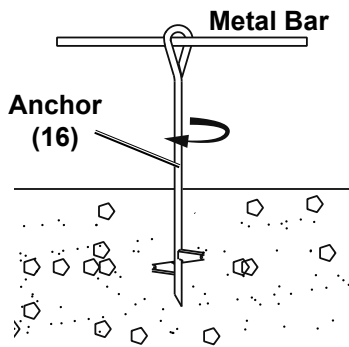

2. Insert the Wire Rope (17) through the Anchor and Corner Foot.

4. Repeat on the other corners.

Note: Center Feet may be anchored to increase stability.

Attach Roof

1. Stretch Top Cover (19) over the frame, making sure it is centered.
2. From the inside, on one side of the Shed, remove the Bottom Rails from the Clamps.
3. Insert the Rails into the pockets at the bottom of the Shed wall and then reinsert the Bottom Rails back into the Clamps.
4. Repeat on other side of Shed.

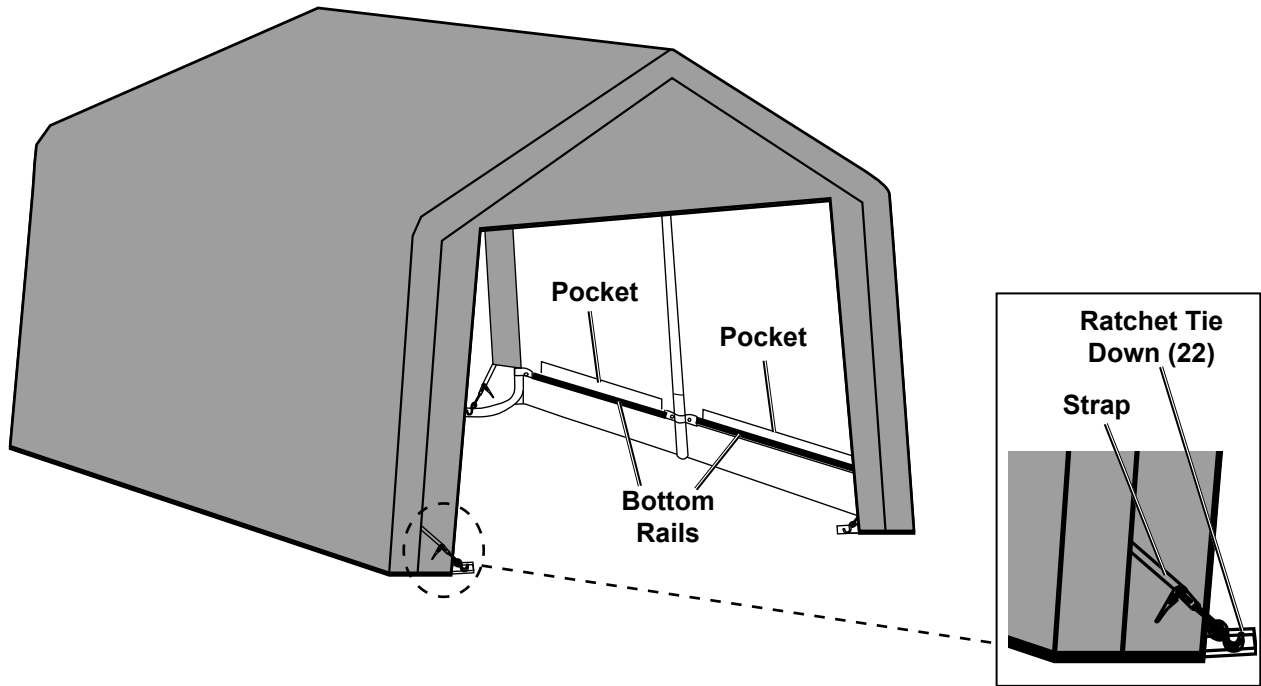

5. From the inside at the corners, thread the Straps through Ratchet Tie Down's spindles. Insert the "S" hook of the Ratchet into the hole in the Corner Feet.

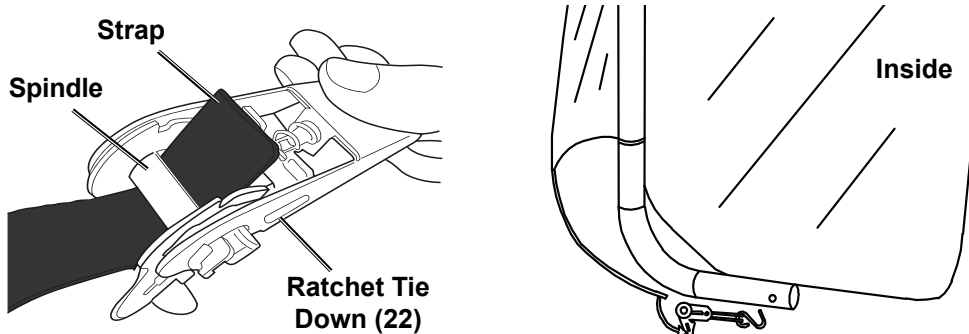

6. Raise and lower the Ratchet Tie Down's handles, alternating between each corner, until straps are slightly tight with a little slack.

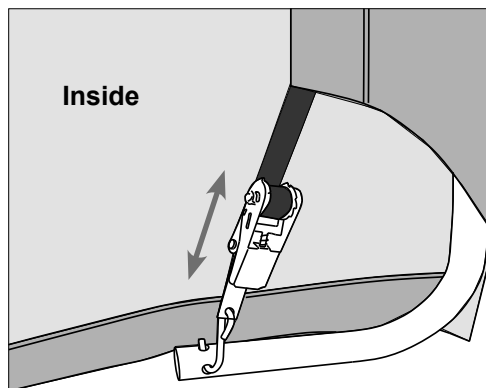

7. Repeat for the other three corners.

Attach Front and Back Covers

1. Position Front Cover (20) so that zipper pulls are facing toward the outside. Make sure zippers are closed.
2. From inside, wrap the hook and loop straps around the Rails. Make sure to connect all straps. Secure straps completely around the Rails.

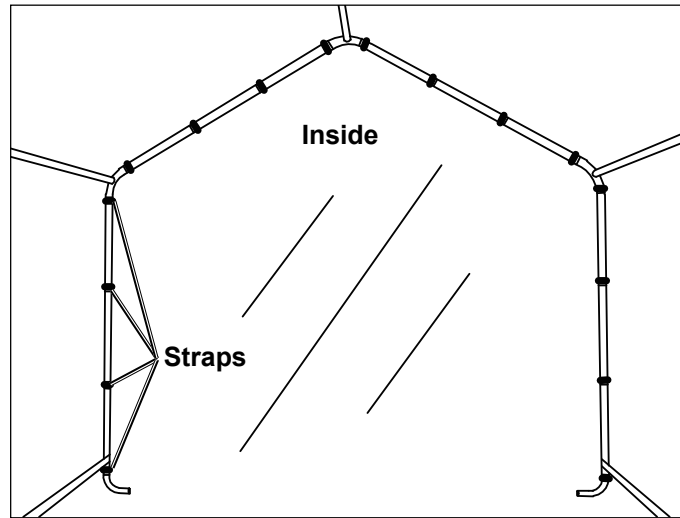

3. Repeat for Back Cover (21).
4. From the inside, using a wrench (not included), tighten the Ratchet Tie Down's handles, alternating between each corner, until straps are snug.

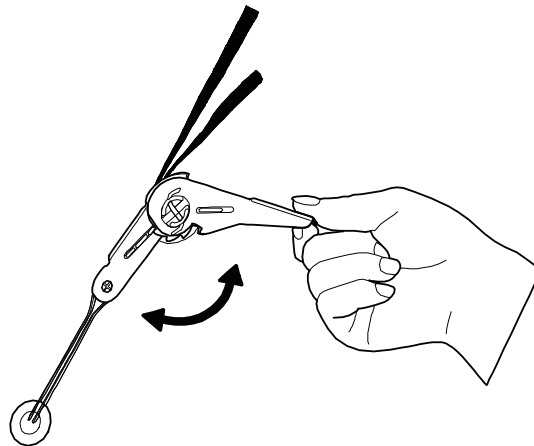

5. **Tighten all connections throughout the shed before use.**
Do not overtighten.



Maintenance



Procedures not specifically explained in this manual must be performed only by a qualified technician.

WARNING

TO PREVENT SERIOUS INJURY FROM PRODUCT FAILURE:

Do not use damaged products. If damage is noted, have the problem corrected before further use.

Inspection

MONTHLY, inspect the general condition of the Portable Shed. Check for:

- loose ratchet tie downs, anchors, tube connections, and rail clamps (tighten as needed),
- torn or frayed covers, ropes, or wire ropes,
- cracked, bent, or broken parts, and
- any other condition that may affect its safe operation.

Cleaning

1. Immediately remove any accumulated debris from the cover with a broom, mop, or other soft-sided instrument from the outside. **DO NOT** use sharp instruments.
2. **PERIODICALLY**, clean cover with mild soap and water. **DO NOT** use bleach or harsh abrasive products.

PLEASE READ THE FOLLOWING CAREFULLY

THE MANUFACTURER AND/OR DISTRIBUTOR HAS PROVIDED THE PARTS LIST IN THIS MANUAL AS A REFERENCE TOOL ONLY. NEITHER THE MANUFACTURER OR DISTRIBUTOR MAKES ANY REPRESENTATION OR WARRANTY OF ANY KIND TO THE BUYER THAT HE OR SHE IS QUALIFIED TO MAKE ANY REPAIRS TO THE PRODUCT, OR THAT HE OR SHE IS QUALIFIED TO REPLACE ANY PARTS OF THE PRODUCT. IN FACT, THE MANUFACTURER AND/OR DISTRIBUTOR EXPRESSLY STATES THAT ALL REPAIRS AND PARTS REPLACEMENTS SHOULD BE UNDERTAKEN BY CERTIFIED AND LICENSED TECHNICIANS, AND NOT BY THE BUYER. THE BUYER ASSUMES ALL RISK AND LIABILITY ARISING OUT OF HIS OR HER REPAIRS TO THE ORIGINAL PRODUCT OR REPLACEMENT PARTS THERETO, OR ARISING OUT OF HIS OR HER INSTALLATION OF REPLACEMENT PARTS THERETO.





Record Product's Serial Number Here: _____





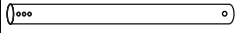
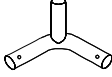
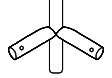

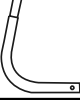
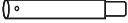
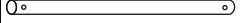
Note: If product has no serial number, record month and year of purchase instead.

Note: Some parts are listed and shown for illustration purposes only, and are not available individually as replacement parts.

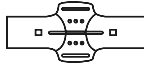
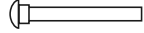
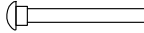
Parts List

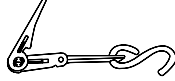
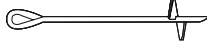
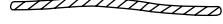
Note: Individual part illustrations not to scale.

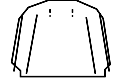
Part	Description	Illustration	Qty
1	Rafter		6
2	Top Rail/Leg		12
3	3-Way Rail Connector		2
4	4-Way Rail Connector		1
5	3-Way Corner Connector		4
6	4-Way Center Connector		2
7	Corner Foot		4
8	Center Foot		2
9	Bottom Rail		4
10	Corner Clamp		8

Part	Description	Illustration	Qty
11	Center Clamp		4
12	Bolt M6 x 40		8
13	Bolt M6 x 50		6
14	Nut M6		14
15	Ratchet Tie Down		4
16	Anchor		4
17	Wire Rope		4
18	Wire Rope Clamp		4
19	Top Cover		1
20	Front Cover		1
21	Back Cover		1

Limited 90 Day Warranty

Harbor Freight Tools Co. makes every effort to assure that its products meet high quality and durability standards, and warrants to the original purchaser that this product is free from defects in materials and workmanship for the period of 90 days from the date of purchase. This warranty does not apply to damage due directly or indirectly, to misuse, abuse, negligence or accidents, repairs or alterations outside our facilities, criminal activity, improper installation, normal wear and tear, or to lack of maintenance. We shall in no event be liable for death, injuries to persons or property, or for incidental, contingent, special or consequential damages arising from the use of our product. Some states do not allow the exclusion or limitation of incidental or consequential damages, so the above limitation of exclusion may not apply to you. THIS WARRANTY IS EXPRESSLY IN LIEU OF ALL OTHER WARRANTIES, EXPRESS OR IMPLIED, INCLUDING THE WARRANTIES OF MERCHANTABILITY AND FITNESS.

To take advantage of this warranty, the product or part must be returned to us with transportation charges prepaid. Proof of purchase date and an explanation of the complaint must accompany the merchandise. If our inspection verifies the defect, we will either repair or replace the product at our election or we may elect to refund the purchase price if we cannot readily and quickly provide you with a replacement. We will return repaired products at our expense, but if we determine there is no defect, or that the defect resulted from causes not within the scope of our warranty, then you must bear the cost of returning the product.

This warranty gives you specific legal rights and you may also have other rights which vary from state to state.

