

Model
HC06

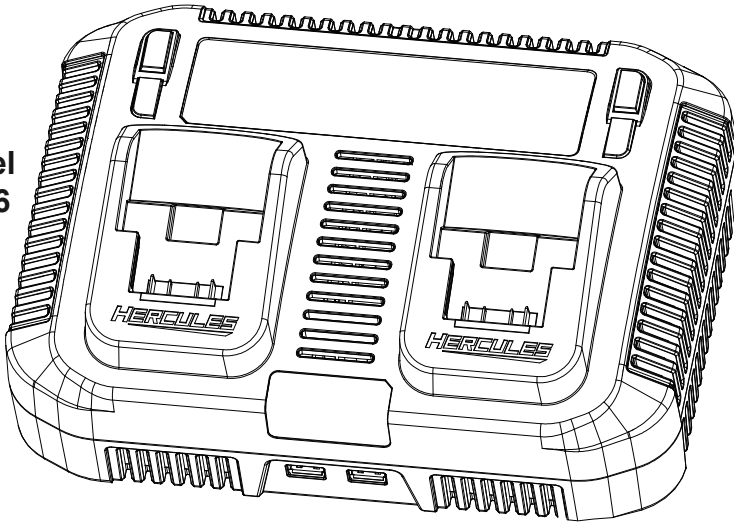

20V/12V Lithium-Ion Dual Port Charger with USB

▲WARNING: To prevent serious injury, User must read and understand Owner's Manual. **SAVE THIS MANUAL.**

When unpacking, make sure that the product is intact and undamaged.
If any parts are missing or broken, please call 1-888-866-5797
as soon as possible. Reference 56224.

IMPORTANT SAFETY INFORMATION

WARNING

Read all safety warnings and all instructions.

Failure to follow the warnings and instructions may result in electric shock, fire and/or serious injury. Save all warnings and instructions for future reference.

The warnings, precautions, and instructions discussed in this instruction manual cannot cover all possible conditions and situations that may occur.

It must be understood by the operator that common sense and caution are factors which cannot be built into this product, but must be supplied by the operator.

-  The battery Charger gets hot during use. The Charger's heat can build up to unsafe levels and create a fire hazard if it does not receive adequate ventilation, due to an electrical fault, or if it is used in a hot environment. Do not place the Charger on a flammable surface. Do not obstruct any vents on the Charger. **Especially avoid placing the Charger on carpets and rugs; they are not only flammable, but they also obstruct vents under the Charger.** Place the Charger on a stable, solid, nonflammable surface (such as a stable metal workbench or concrete floor) at least 1 foot away from all flammable objects, such as drapes or walls. Keep a fire extinguisher and a smoke detector in the area. Frequently monitor the Charger and Battery Pack while charging.
- Charge only designated battery packs; others may overheat, leak, or burst.**
- Follow charging instructions.**
- Do not insert damaged battery pack.**
- Check frequently while charging.**
- Wear ANSI-approved safety goggles during use.**
- Use chargers only with specifically designated battery packs.** *Use of any other battery packs may create a risk of injury and fire.*
- When battery pack is not in use, keep it away from other metal objects, like paper clips, coins, keys, nails, screws or other small metal objects, that can make a connection from one terminal to another.** *Shorting the battery pack terminals together may cause burns or a fire.*
- Under abusive conditions, liquid may be ejected from the battery pack; avoid contact. If contact accidentally occurs, flush with water. If liquid contacts eyes, additionally seek medical help.** *Liquid ejected from the battery pack may cause irritation or burns.*

- Do not expose to rain or wet conditions. Indoor use only.
- Inspect before every use; do not use if parts are loose or damaged.
- Use as intended only.
- Unplug after use and before service, cleaning or storage.
- Maintain labels and nameplates on the Charger. These carry important safety information. If unreadable or missing, contact Harbor Freight Tools for a replacement.
- This product is not a toy. Keep it out of reach of children.
- People with pacemakers should consult their physician(s) before use. Electromagnetic fields in close proximity to heart pacemaker could cause pacemaker interference or pacemaker failure. In addition, people with pacemakers should properly maintain and inspect to avoid electrical shock.

Lithium Battery Safety Warnings



**LITHIUM BATTERIES
STORE A LARGE AMOUNT
OF ENERGY AND WILL**

VENT FIRE OR EXPLODE IF MISTREATED:

- Keep Battery Pack dry.
- DO NOT DO ANY OF THE FOLLOWING TO THE BATTERY PACK:**
 - Open,
 - Drop,
 - Short-circuit,
 - Puncture,
 - Incinerate, or
 - Expose to temperatures greater than 140°F.
- Charge Battery Pack only according to instructions.
- Inspect Battery Pack before every use; do not use or charge if damaged.



**SAVE THESE
INSTRUCTIONS**

Grounding

⚠️ WARNING



TO PREVENT ELECTRIC SHOCK AND DEATH FROM INCORRECT GROUNDING: Check with a qualified electrician if you are in doubt as to whether the outlet is properly grounded. Do not modify the power cord plug provided with the charger. Do not use the charger if the power cord or plug is damaged. If damaged, have it repaired by a service facility before use. If the plug will not fit the outlet, have a proper outlet installed by a qualified electrician.

Extension Cords

Extension cords must not be used with this Charger.

Warning Symbols and Definitions

⚠️ This is the safety alert symbol. It is used to alert you to potential personal injury hazards. Obey all safety messages that follow this symbol to avoid possible injury or death.





⚠️ DANGER Indicates a hazardous situation which, if not avoided, will result in death or serious injury.

⚠️ WARNING Indicates a hazardous situation which, if not avoided, could result in death or serious injury.

⚠️ CAUTION Indicates a hazardous situation which, if not avoided, could result in minor or moderate injury.

NOTICE Addresses practices not related to personal injury.

Symbology

V	Volts
— — —	Direct Current
~	Alternating Current
A	Amperes
	WARNING marking concerning Risk of Eye Injury. Wear ANSI-approved safety goggles with side shields.
	Read the manual before set-up and/or use.
	WARNING marking concerning Risk of Fire. Do not cover Charger ventilation ducts. Charge on fireproof surface only.
	WARNING marking concerning Risk of Explosion. Do not puncture, short, or open battery packs and do not charge damaged battery packs.
	WARNING marking concerning Risk of Electric Shock. Properly connect Charger's power cord to appropriate outlet.

FUNCTIONAL DESCRIPTION

SPECIFICATIONS

Input Rating	120VAC / 60Hz
Battery Type	Hercules 12/20 VDC Li-Ion (sold separately)
USB Output	2 Ports 2A Max

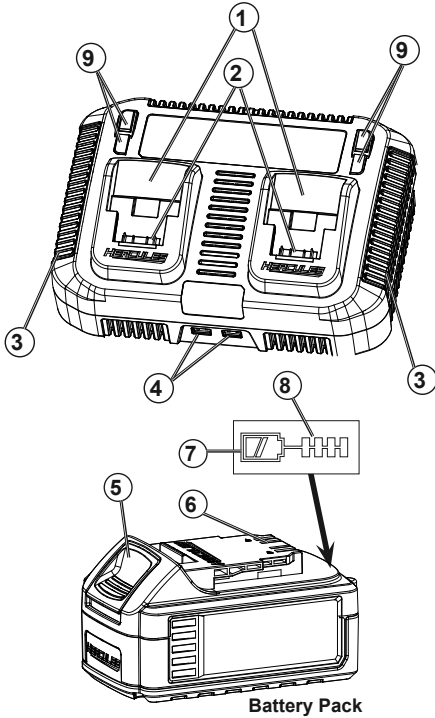

Battery Pack

1. Bays
2. Charge Terminals
3. Vents
4. USB Ports
5. Release Button
6. Battery Terminals
7. Charge Gauge Button
8. Charge Gauge
9. Charge Indicators:



CHARGING
Red Constant
Green Flashing



CHARGED
Red Off
Green Constant



HOT/COLD DELAY
Red Flashing
Green Flashing



PROBLEM PACK OR CHARGER
Red Flashing
Green Off

BATTERY PACK OPERATION

Charge Gauge

Press the Charge Gauge Button on the Battery to check its remaining run time.

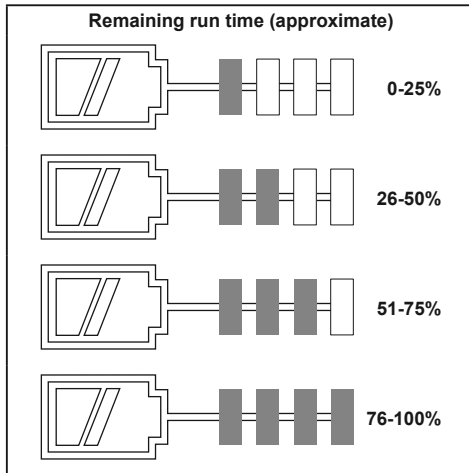

Note: If the Charge Gauge does not display when the Charge Gauge Button is pressed, charge the Battery Pack.

The Battery Pack will shut itself off once it is fully discharged. Charge the Battery Pack when this happens.

Cold Weather

To warm up a Battery Pack that is very cold, operate the tool slowly or in a light application for a few minutes until the Battery Pack warms-up.

Battery Storage

⚠ WARNING

To prevent serious injury, do not do any of the following to the Battery Pack:

- Open,
 - Drop,
 - Short-circuit,
 - Puncture,
 - Incinerate, or
 - Expose to temperatures greater than 140°F.
1. Store batteries in a dry, indoor area at room temperature out of reach of children and away from metal objects (i.e., paperclips, coins) to prevent shorting.

NOTICE: Battery may be damaged if stored at high temperatures (over 120° F).

2. Recharge the Battery Pack at least once a year.

CHARGER OPERATION



Read the **ENTIRE IMPORTANT SAFETY INFORMATION** section at the beginning of this manual including all text under subheadings therein before set up or use of this product.

When to Charge

1. Charge the Battery Pack (sold separately) when convenient.
2. The Battery Pack does not need to be completely discharged before charging. It will not develop a "memory" if charged while still partially full.
3. To help protect the Battery Pack, it must be charged when the charge level is near empty. If a Lithium-Ion battery is allowed to discharge completely, it can be ruined.

Charging Battery Packs

	CHARGING Red Constant _____ Green Flashing - - - - -
	CHARGED Red Off _____ Green Constant _____
	HOT/COLD DELAY Red Flashing - - - - - Green Flashing - - - - -
	PROBLEM PACK OR CHARGER Red Flashing - - - - - Green Off _____

Figure A: Charge Indicators

1. Place the Battery Pack on a dry fireproof surface in a room where the temperature is between 50–104° F.

Note: If recharging a newly spent Battery Pack, allow it to cool completely before charging.

2. Examine the Battery Pack. It must be undamaged, and a 12 or 20 volt, Lithium-Ion type Hercules Battery Pack. **Do not charge a cracked, open, or leaking Battery Pack, or charge a non-recommended type of Battery Pack.**
3. The Battery Pack's terminals are designed to fit this Charger specifically. If the Battery Pack does not fit the Charger properly, do not try to insert it. **Do not force a Battery Pack into the Charger.**
4. Plug the Charger into a grounded, 120VAC, 60Hz receptacle.

5. Slide the Battery Pack onto the Charger until it clicks in. Two Battery Packs may be charged at the same time.
 - A fully discharged 12V Battery Pack will take about 50 minutes to fully charge.
 - A fully discharged 20V 2.5 Ah Battery Pack will take about 62 minutes to fully charge.
 - A fully discharged 20V 5.0 Ah (XP) Battery Pack will take about 118 minutes to fully charge.

Note: If the Battery Pack is hot or cold, the Charge Indicators may both flash, indicating that the Charger is waiting for the temperature to normalize before Charging. Charging will start automatically once the Battery Pack reaches the correct temperature.

6. While charging, the Battery Pack and Charger may become warm to the touch. This is normal, and does not indicate a problem.
7. The red LED will light constantly and the green LED will flash when the Battery Pack is charging. The green LED will light constantly and the red LED will turn off when the battery is charged. **Unplug the Charger and disconnect it from the Battery Pack when finished.**
8. Allow the Battery Pack to cool completely before using it.
9. Press the Release Button to release Battery Pack from the Charger.

Charging USB Devices

1. USB devices (sold separately) may be charged at the same time as charging Battery Packs.
2. Connect one end of a USB cable (sold separately) to USB device (i.e. cell phone, tablet).
3. Connect other end of USB cable to one of the Charger's USB ports.

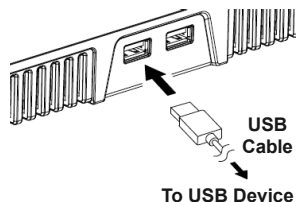

4. **When finished, disconnect the USB cable and unplug the Charger.**

CHARGER MAINTENANCE AND SERVICING



Procedures not specifically explained in this manual must be performed only by a qualified technician.

! WARNING

TO PREVENT SERIOUS INJURY FROM ACCIDENTAL OPERATION:

Remove the Battery Pack and unplug the charger before performing any inspection, maintenance, or cleaning procedures.

TO PREVENT SERIOUS INJURY FROM TOOL FAILURE: Do not use damaged equipment.

If damage is noted, have the problem corrected before further use.

- BEFORE EACH USE**, inspect the general condition of the charger. Check for:
 - loose hardware,
 - misalignment or binding of moving parts,
 - cracked or broken parts,
 - damaged electrical wiring, and
 - any other condition that may affect its safe operation.
- AFTER USE**, wipe external surfaces of the charger with clean cloth.
- Disconnect Power Cord, Battery Pack(s) and USB cable(s). Store Charger and any Battery Packs in a dry, indoor area at room temperature out of reach of children and away from metal objects (i.e., paperclips, coins) to prevent shorting.

WARNING! TO PREVENT SERIOUS INJURY AND DEATH FROM ELECTRIC SHOCK:

Do not open Charger. Do not service internal parts.

This device complies with Part 15 of the FCC Rules. Operation is subject to the following two conditions:

(1) this device may not cause harmful interference, and (2) this device must accept any interference received, including interference that may cause undesired operation.

LIMITED 90 DAY WARRANTY

Harbor Freight Tools Co. makes every effort to assure that its products meet high quality and durability standards, and warrants to the original purchaser that this product is free from defects in materials and workmanship for the period of 90 days from the date of purchase. This warranty does not apply to damage due directly or indirectly, to misuse, abuse, negligence or accidents, repairs or alterations outside our facilities, criminal activity, improper installation, normal wear and tear, or to lack of maintenance. We shall in no event be liable for death, injuries to persons or property, or for incidental, contingent, special or consequential damages arising from the use of our product. Some states do not allow the exclusion or limitation of incidental or consequential damages, so the above limitation of exclusion may not apply to you. THIS WARRANTY IS EXPRESSLY IN LIEU OF ALL OTHER WARRANTIES, EXPRESS OR IMPLIED, INCLUDING THE WARRANTIES OF MERCHANTABILITY AND FITNESS.

To take advantage of this warranty, the product or part must be returned to us with transportation charges prepaid. Proof of purchase date and an explanation of the complaint must accompany the merchandise. If our inspection verifies the defect, we will either repair or replace the product at our election or we may elect to refund the purchase price if we cannot readily and quickly provide you with a replacement. We will return repaired products at our expense, but if we determine there is no defect, or that the defect resulted from causes not within the scope of our warranty, then you must bear the cost of returning the product.

This warranty gives you specific legal rights and you may also have other rights which vary from state to state.

Record Product's Serial Number Here: _____

Note: If product has no serial number, record month and year of purchase instead.

Replacement parts are not available.

Visit our website at: <http://www.harborfreight.com>
Email our technical support at: productsupport@harborfreight.com
For technical questions, please call 1-888-866-5797

Copyright© 2019 by Harbor Freight Tools®. All rights reserved. No portion of this manual or any artwork contained herein may be reproduced in any shape or form without the express written consent of Harbor Freight Tools. Diagrams within this manual may not be drawn proportionally. Due to continuing improvements, actual product may differ slightly from the product described herein. Tools required for assembly and service may not be included.

HERCULES®

26541 Agoura Road • Calabasas, CA 91302 • 1-888-866-5797