

Specifications

Jackscrew Threading	5/8"-18
Ford® 4.6L Threading	3/8"-16 to M8-1.25
GM® 3.1L Threading	3/8"-16
Quad 4 Threading	3/8"-16
Threading on all others	3/8"-16

MADDOX
SUPERIOR AUTOMOTIVE TOOLS

Important Safety Information

1. Assemble and use only according to these instructions. Improper assembly and usage can create hazards.
2. Wear ANSI-approved safety goggles and heavy-duty work gloves during assembly and use.
3. Keep area clean and well lit.
4. Use only according to vehicle service instructions.
5. Inspect before every use; do not use if parts are loose or damaged.
6. Keep children and other bystanders out of the area.
7. Do not use when tired or when under the influence of drugs or medication.
8. Use as intended only.
9. Maintain product labels and nameplates. These carry important safety information. If unreadable or missing, contact Harbor Freight Tools for a replacement.

MADDOX
SUPERIOR AUTOMOTIVE TOOLS

Operation Instructions



Read the **ENTIRE IMPORTANT SAFETY INFORMATION** section at the beginning of this document including all text under subheadings therein before set up or use of this product.

Removal

1. Coat Jackscrew (5) with lubricant and thread into Puller Body (1).

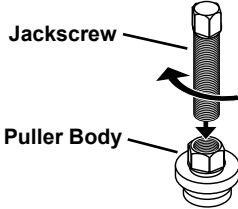

2. Push Button (6) or appropriate Puller Pin (11 or 12) into hole in Jackscrew.

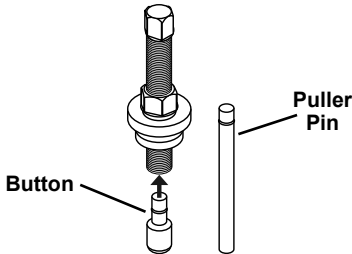

3. Insert Jackscrew assembly, then assemble Jaws (2a) over Puller Body and pulley flange.

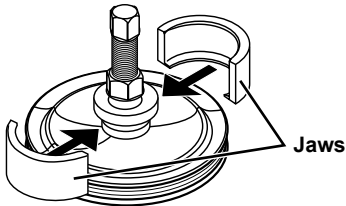

4. Hand tighten Jackscrew and slide Jaw Sleeve (2b) into position over Jaws.

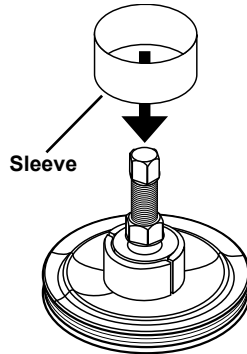

5. Hold Puller Body with 1" or adjustable wrench (sold separately). Turn Jackscrew clockwise with 1/2" socket wrench (sold separately) until pulley is removed.

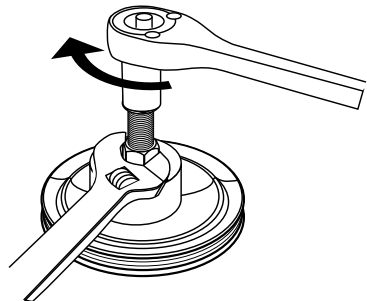

Installation (All Models)

1. Coat Jackscrew (5) with lubricant and thread into Puller Body (1).

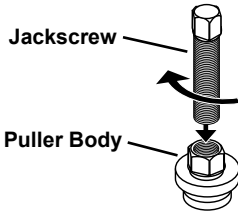

2. Insert small end of appropriate Screw Installer (7, 8, 9 or 10) into hole in Jackscrew and tighten in place.

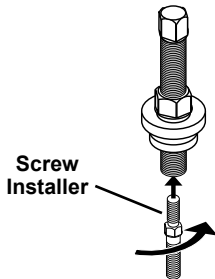

3. Place Bearing (3), then Thrust Washer (4) over the Screw Installer and up next to the Puller Body.

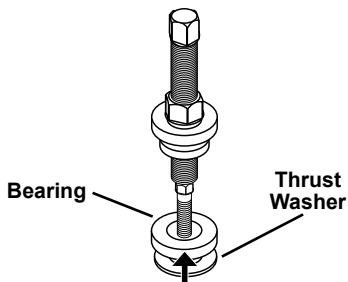

4. Insert the pilot end of the appropriate Screw Installer through the pulley and thread into the pump shaft until Screw Installer bottoms.

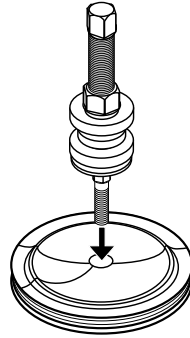

5. Hold Jackscrew with a 1/2" socket wrench (sold separately) and turn Puller Body counterclockwise with a 1" or adjustable wrench (sold separately) until the pulley is in position.

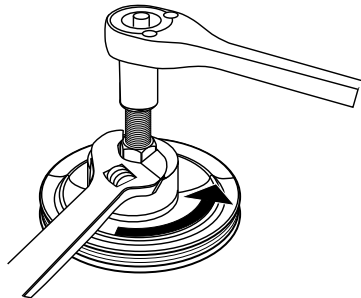

Maintenance

⚠️WARNING

TO PREVENT SERIOUS INJURY FROM TOOL FAILURE:

Do not use damaged equipment. If abnormal noise or vibration occurs, have the problem corrected before further use.

Cleaning, Maintenance, and Lubrication

1. **BEFORE EACH USE**, inspect the general condition of the tool set. Check for:
 - loose hardware
 - misalignment or binding of moving parts
 - cracked or broken parts
 - any other condition that may affect its safe operation.
2. **AFTER USE**, wipe the tools off with a clean cloth.
3. When storing, coat all parts with a light oil to prevent rust, then store them in the Carrying Case.

PLEASE READ THE FOLLOWING CAREFULLY

THE MANUFACTURER AND/OR DISTRIBUTOR HAS PROVIDED THE PARTS LIST AND ASSEMBLY DIAGRAM IN THIS DOCUMENT AS A REFERENCE TOOL ONLY. NEITHER THE MANUFACTURER OR DISTRIBUTOR MAKES ANY REPRESENTATION OR WARRANTY OF ANY KIND TO THE BUYER THAT HE OR SHE IS QUALIFIED TO MAKE ANY REPAIRS TO THE PRODUCT, OR THAT HE OR SHE IS QUALIFIED TO REPLACE ANY PARTS OF THE PRODUCT. IN FACT, THE MANUFACTURER AND/OR DISTRIBUTOR EXPRESSLY STATES THAT ALL REPAIRS AND PARTS REPLACEMENTS SHOULD BE UNDERTAKEN BY CERTIFIED AND LICENSED TECHNICIANS, AND NOT BY THE BUYER. THE BUYER ASSUMES ALL RISK AND LIABILITY ARISING OUT OF HIS OR HER REPAIRS TO THE ORIGINAL PRODUCT OR REPLACEMENT PARTS THERETO, OR ARISING OUT OF HIS OR HER INSTALLATION OF REPLACEMENT PARTS THERETO.

Parts List and Diagram

Part	Description	Qty.
1	Puller Body	1
2a	Jaw	2
2b	Sleeve	1
3	Bearing	1
4	Thrust Washer	1
5	Jackscrew	1
6	Button	1

Part	Description	Qty.
7	Screw Installer for Ford® 4.6L Modular	1
8	Screw Installer for GM® 3.1L	1
9	Screw Installer for Quad 4	1
10	Screw Installer for All Others	1
11	Puller Pin for GM® 3.1L	1
12	Puller Pin for Quad 4	1
13	Carrying Case (not shown)	1



Record Serial Number Here:

Note: If product has no serial number, record month and year of purchase instead.

Note: Some parts are listed and shown for illustration purposes only, and are not available individually as replacement parts.

Limited 90 Day Warranty

Harbor Freight Tools Co. makes every effort to assure that its products meet high quality and durability standards, and warrants to the original purchaser that this product is free from defects in materials and workmanship for the period of 90 days from the date of purchase. This warranty does not apply to damage due directly or indirectly, to misuse, abuse, negligence or accidents, repairs or alterations outside our facilities, criminal activity, improper installation, normal wear and tear, or to lack of maintenance. We shall in no event be liable for death, injuries to persons or property, or for incidental, contingent, special or consequential damages arising from the use of our product. Some states do not allow the exclusion or limitation of incidental or consequential damages, so the above limitation of exclusion may not apply to you. THIS WARRANTY IS EXPRESSLY IN LIEU OF ALL OTHER WARRANTIES, EXPRESS OR IMPLIED, INCLUDING THE WARRANTIES OF MERCHANTABILITY AND FITNESS.

To take advantage of this warranty, the product or part must be returned to us with transportation charges prepaid. Proof of purchase date and an explanation of the complaint must accompany the merchandise. If our inspection verifies the defect, we will either repair or replace the product at our election or we may elect to refund the purchase price if we cannot readily and quickly provide you with a replacement. We will return repaired products at our expense, but if we determine there is no defect, or that the defect resulted from causes not within the scope of our warranty, then you must bear the cost of returning the product.

This warranty gives you specific legal rights and you may also have other rights which vary from state to state.

MADDOX[®]
SUPERIOR AUTOMOTIVE TOOLS