

# Owner's Manual & Safety Instructions

**Save This Manual** Keep this manual for the safety warnings and precautions, assembly, operating, inspection, maintenance and cleaning procedures. Write the product's serial number in the back of the manual near the assembly diagram (or month and year of purchase if product has no number). Keep this manual and the receipt in a safe and dry place for future reference.

21h

# BADLAND®

## ZXR2500

### ATV / UTILITY WINCH



Visit our website at: <http://www.harborfreight.com>  
Email our technical support at: [productsupport@harborfreight.com](mailto:productsupport@harborfreight.com)

**56258**

When unpacking, make sure that the product is intact and undamaged. If any parts are missing or broken, please call 1-888-866-5797 as soon as possible.







Copyright© 2021 by Harbor Freight Tools®. All rights reserved.  
No portion of this manual or any artwork contained herein may be reproduced in any shape or form without the express written consent of Harbor Freight Tools. Diagrams within this manual may not be drawn proportionally. Due to continuing improvements, actual product may differ slightly from the product described herein. Tools required for assembly and service may not be included.

## **⚠️WARNING**

Read this material before using this product. Failure to do so can result in serious injury. **SAVE THIS MANUAL.**

## Specifications

Rated Single Line Pull	2500 lb (1134 kg)	Wire Rope Size / Type	Ø5/32" x 50' (Ø4 mm x 15.2 m) Nominal strength=2,800 lb 7 x 19 Galvanized Steel Aircraft Wire Rope
Application	Utility/Shop/ATV	Battery	12VDC, Minimum 12 Ah
Motor	12VDC 1 HP Permanent Magnet	Battery Cables	10 gauge, 5.8' (1.78m) long
Power IN & Power OUT	Yes	Mounting Pattern	3.15" (80mm)
Duty Cycle Rating	5% (45 sec at Max Rated Load; 14 min, 15 sec Rest)	Mounting Hardware	<b>Winch:</b> 2x G8, M8-1.25 x 35mm <b>Fairlead:</b> 2x G8, M8-1.25 x 19mm
Geartrain	Single-stage Planetary	Overload Protection	In-line Circuit Breaker
Gear Ratio	153:1	Sound Rating	85 dB
Freespool	Yes	Overall Dimensions (L x D x H)	11.25" x 3.88" x 4.25" (286 x 99 x 108mm)
Brake	Auto. Load Holding Dynamic	Weight	14.7 lb (6.7 kg)
Drum (Dia. x L)	1.25" x 2.8" (32mm x 71 mm)	IP Rating	IP 65 - Winch and Controls (resistant to water jets)
Hook	1/4" Eye Hook		
Fairlead	Roller with nylon bushings		











Layer	Rated Line Pull	Wire Rope Capacity
 1	2500 lb (1134 kg)	6' (1.8m)
 2	2045 lb (928 kg)	13.3' (4.0m)
 3	1731 lb (785 kg)	21.9' (6.7m)
 4	1500 lb (680 kg)	31.8' (9.7m)
 5	1324 lb (600 kg)	43.1' (13.1m)
 6	1184 lb (537 kg)	50' (15.2m)



### First Layer of Wire Rope Performance

	Line Pull lb (kg)	Line Speed fpm (mpm)	Amp Draw (@ 12V)
 1	0 (0)	13.3 (4)	10
	500 (226)	10.8 (3.2)	30
	1000 (453)	8.3 (2.5)	55
	1500 (680)	6.2 (1.8)	80
	2000 (907)	4.1 (1.2)	106
	2500 (1133)	2.7 (0.8)	132

## WARNING SYMBOLS AND DEFINITIONS

	This is the safety alert symbol. It is used to alert you to potential personal injury hazards. Obey all safety messages that follow this symbol to avoid possible injury or death.
<b>⚠ DANGER</b>	Indicates a hazardous situation which, if not avoided, will result in death or serious injury.
<b>⚠ WARNING</b>	Indicates a hazardous situation which, if not avoided, could result in death or serious injury.
<b>⚠ CAUTION</b>	Indicates a hazardous situation which, if not avoided, could result in minor or moderate injury.
<b>NOTICE</b> <b>CAUTION</b>	Addresses practices not related to personal injury.

Symbol	Property or Statement
	Wear heavy-duty, cut- and abrasion-resistant leather gloves.
	Wear ANSI-approved safety glasses.
	Cut or sever hazard.
	Roller entanglement hazard.
	Hot surface burn hazard.
	Fire hazard.
	Caustic chemical (acid) hazard.
	Explosion hazard.
	Do not loop the wire rope around object and hook onto itself.
	Do not place finger(s) through hook. Fingers may be caught and get pulled into fairlead or drum.
	Pull hook using strap only.

Symbol	Property or Statement
	Do not use winch in overwind orientation. (Wire rope enters/exits at the top.)
	Use winch only in underwind orientation. (Wire rope enters/exits at the bottom.)
<b>VDC</b>	Volts Direct Current
<b>A</b>	Amperes
<b>CCA</b>	Cold Cranking Amperes
<b>HP</b>	Horsepower
<b>fpm</b>	Feet Per Minute
<b>mpm</b>	Meters Per Minute
<b>RPM</b>	Revolutions Per Minute
<b>IP</b>	International Protection rating Classifies the degrees of protection provided against the intrusion of solid objects, dust, accidental contact, and water.
<b>G8</b>	Grade 8 A fastener strength rating.

## Important Safety Information



**WARNING! Read all instructions.**

**Failure to follow all instructions may result in fire, serious injury and/or DEATH.**

The warnings and precautions discussed in this manual cannot cover all possible conditions and situations that may occur. It must be understood by the operator that common sense and caution are factors which cannot be built into this product, but must be supplied by the operator.

## Installation Precautions



1. Do not wear loose clothing or jewelry, as they can be caught in moving parts. Non-skid footwear is recommended. Wear restrictive hair covering to contain long hair.
2. Wear ANSI-approved safety goggles and heavy-duty leather work gloves during installation.
3. Before installation confirm that area is clear of fuel lines, brake lines, electrical wires, gas tanks or any other component which could be damaged during drilling.
4. Mounting location and hardware must support winch and load.
5. Use supplied power cords and wire rope listed in manual only. Do not use thinner/longer cables or link multiple cables together.
6. Do not route electrical cables near sharp edges or parts that will move or become hot.
7. Ventilate area well before and while working on battery. Explosive invisible hydrogen gas can accumulate and then explode when ignited by a spark from the battery connection.
8. Only connect to a clean, corrosion free battery.
9. Do not lean over or come in contact with battery while making connections.
10. Remove all metal jewelry before working near battery.
11. Connect red wire to positive battery terminal and black wire to negative battery terminal.
12. Insulate all exposed wiring and terminals after installation.
13. Install winch and fairlead in underwind orientation, so that the wire rope enters and exits the winch at the bottom of the drum.

## Operation Precautions



1. Do not exceed load capacity. **Be aware of dynamic loading!** Sudden load movement may briefly create excess load causing product failure.
2. **Do not maintain power to the winch if the motor stalls.** Verify load is within rated capacity for the wire rope layer—see *Specifications* on page 2. Make sure the battery is fully charged. Use double line rigging whenever possible. Refer to *Double Line Rigging* on page 11.
3. Wear ANSI-approved safety goggles and heavy-duty leather work gloves during operation.
4. Do not disengage clutch under load. Engage clutch before starting.
5. Keep clear of fairlead when operating. Do not try to guide wire rope.
6. **Do not place finger(s) through hook or shackle.** Fingers may be caught and get pulled into fairlead or drum. Use included strap to hold hook instead.

7. Stay out of the direct line that the wire rope is pulling. If it slips or breaks, it will “whiplash” along this line. Place a heavy blanket or winch damper over the wire rope span 6 feet from hook to help absorb the force released if the wire rope breaks. Refer to Figure A.

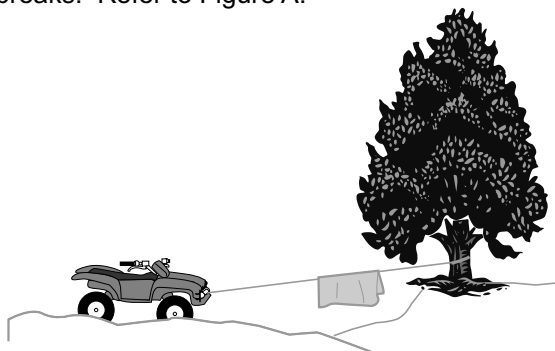

**Figure A: Whiplash Dampening Blanket or Winch Damper**

8. Do not use for lifting or moving people.
9. Use a spotter to assist you in ensuring that it is safe to operate the winch. Make sure the spotter is out of the way of the vehicle and the wire rope before activating the winch.
10. Do not use the hand crank, if equipped, to “assist” the winch.
11. Do not use vehicle to pull on the wire rope and “assist” the winch.
12. Use as intended only. Do not lift items vertically or use for aircraft purposes.
13. Prevent entanglement. Do not wear loose clothing or jewelry, as they can be caught in moving parts. Non-skid footwear is recommended. Wear restrictive hair covering to contain long hair.
14. Disconnect battery cables before working near the wire rope, drum, fairlead or load, to prevent accidental starting.
15. Inspect before every use; do not use if damaged or parts loose. Examine the winch for structural cracks, bends, damage, frayed or kinked wire rope, and any other conditions that may affect the safe operation of the winch. Do not use the winch even if minor damage appears. A kink permanently weakens the wire rope, even after it is straightened out; kinked wire rope can fail suddenly and must not be used.
16. Keep wire rope straight to avoid kinking the wire rope. The illustrations below show how a kink forms and how to prevent kinking.

- a. This illustration shows a kink about to form. At this point the winch should be stopped and the wire rope should be straightened out to prevent kinking.

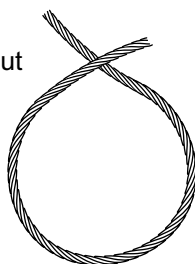

- b. This wire rope is kinked. It is too late to reverse the damage at this point, the wire rope must be discarded. It is permanently damaged and must not be used.

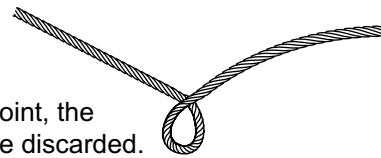

- c. This is a kinked wire rope that has been straightened out. Even though it has been pulled straight, some wires in the wire rope are stretched, and others are severely bent, if not broken. The unstretched wires will take more load and can fail suddenly before the rope reaches its capacity. This wire rope must be discarded and not be used.



A kink permanently weakens the wire rope, even after it is straightened out; kinked wire rope can fail suddenly and must not be used.

17. Keep children and bystanders away while operating. Distractions can cause you to lose control.
18. Stay alert, watch what you are doing and use common sense when operating. Do not use a winch while you are tired or under the influence of drugs, alcohol or medication. A moment of inattention while operating winches may result in serious personal injury.
19. Do not overreach. Keep proper footing and balance at all times. This enables better control of the winch in unexpected situations.
20. Hook onto the object using a pulling point, tow strap or chain. Do not wrap the wire rope around the object and hook onto the wire rope itself. This can cause damage to the object being pulled, and kink or fray the wire rope.
21. **Do not use a recovery strap while winching.** They are designed to stretch and can suddenly whip back towards the operator during a winching operation.
22. Secure load after moving.  
NO LOCKING MECHANISM.
23. Keep at least 5 full turns of wire rope on drum. The wire rope’s connection to the drum is not intended to sustain a load, without the added support from the friction of at least 5 full turns of wire rope.
24. Wrap wire rope under 500 lb. tension before use. Otherwise, wire rope may bind during operation.

25. Keep clear of wire rope, hook, and load while winching. Do not step over wire rope.  
**Do not push sideways against wire rope under tension; wire rope might break under this load and recoil back, striking the person pushing against it or a bystander.**
26. If wire rope begins to get entangled, stop winch immediately and release wire rope using switch.
27. Only winch with the winching vehicle's transmission in neutral. Winching with a vehicle's transmission in gear or park may damage the transmission. A vehicle's transmission is not designed to handle that type of load.
28. Do not operate the winch at extreme angles. Do not exceed the angles shown in Figure B for a roller fairlead. For a hawse fairlead, the angle should be as close to straight as possible.

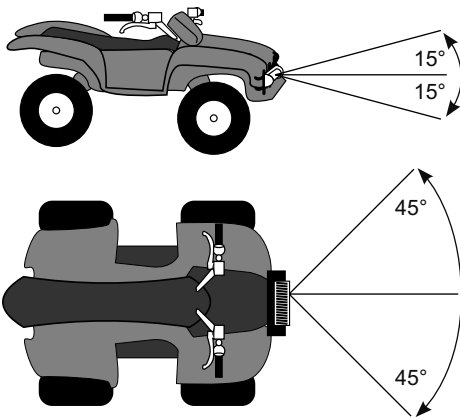

Figure B: Roller Fairlead Maximum Winching Angles

29. If the object to be pulled must be pulled at an angle in relation to the winch, use a snatch block (sold separately) and an anchor point directly in front of the winch, as shown in Figure C, to keep the wire rope pull straight.

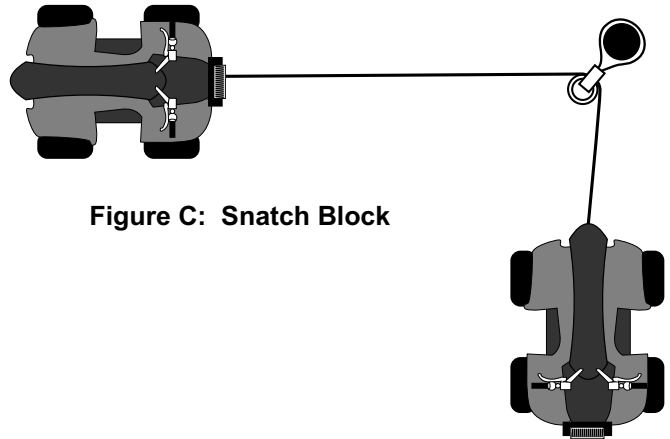

Figure C: Snatch Block

30. Broken strands of wire rope will be sharp. Wear heavy-duty work gloves when handling the wire rope. Do not slide wire rope through hands, even with gloves on.
31. Winch motor will be hot during and after use. Keep clear.
32. Do not power the hook all the way into the fairlead or winch.
33. People with pacemakers should consult their physician(s) before use. Electromagnetic fields in close proximity to heart pacemaker could cause pacemaker interference or pacemaker failure.

## Wireless Operation Precautions

1. Do not use near sources of radio interference or other remote control systems. They may interfere with operation or cause unexpected operation.
2. If Wire Rope unexpectedly moves, reverses, or stops, disconnect Battery Cable from Circuit Breaker immediately to prevent serious injury from sudden Wire Rope movement.
3. Only use Wireless Remote while Winch, Fairlead, Wire Rope, and object being winched/anchor point are all clearly in view.
4. Do not use more than one Remote Transmitter near a Receiver. Additional Transmitters should be turned off and be stored with their batteries removed to prevent accidental operation.
5. Do not use a damaged or malfunctioning Wireless Remote. If Wireless Remote does not work properly, discontinue use immediately and remove its batteries.

## Service Precautions



1. Wear ANSI-approved safety goggles and heavy-duty leather work gloves during service.
2. Disconnect power to Winch and allow it to cool completely before service.
3. Use supplied power cords/wire rope or cables listed in manual only. Do not use thinner/longer cables or link multiple cables together.

4. Have the winch serviced by a qualified repair person using only identical replacement parts. This will ensure that the safety of the winch is maintained.
5. Maintain labels and nameplates on the winch. These carry important safety information. If unreadable or missing, contact Harbor Freight Tools for a replacement.
6. Receiver and Wireless Remote contain no user-servicable parts except the Remote's batteries. Other than for battery replacement, do not open their housing.



## SAVE THESE INSTRUCTIONS.

### Installation and Setup



Read the **ENTIRE IMPORTANT SAFETY INFORMATION** section at the beginning of this manual including all text under subheadings therein before set up or use of this product.

### Mounting the Winch

1. The plate must be rated to at least the Winch's capacity.
2. Align the Winch perpendicular to center line of the vehicle at the desired location, and mark the locations of the Winch base holes. Compare the dimensions of the marked holes to Figure D.
3. Before drilling, verify that the installation surface has no hidden components or structural pieces that will be damaged.

**Note:** This Winch can generate extreme forces. Select a location that can withstand the rated capacity without damage or weakening. Steel reinforcement plates may be needed or a certified welder may need to weld on additional bracing depending on the mounting location.

4. Drill holes appropriate for the hardware at the marked locations.
5. Install the Winch using hardware described under *Specifications*.

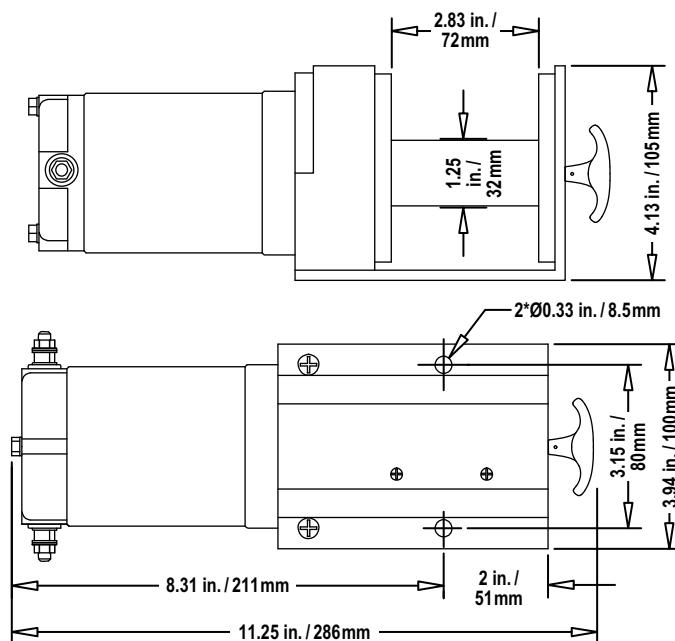

Figure D: Winch Dimensions

### Mounting Winch Components

1. Mount Receiver in proper location so that:
  - a. Winch components are close enough to each other to allow wires to be routed properly.
  - b. Vehicle component operation is not interfered with.
  - c. Vehicle components are not damaged by drilling or driving screws.
  - d. Winch components will not be damaged by stresses caused by vehicle operation.
2. Mark the locations where the screw holes will be.
3. Verify that the installation surface has no hidden components or structural pieces that will be damaged before drilling.
4. Drill pilot holes for the mounting screws.
5. Secure in place with mounting screws.

# Wiring

## ⚠ WARNING



**TO PREVENT SERIOUS INJURY FROM EXPLOSION DUE TO SPARKING AT THE BATTERY CONNECTION:**  
Disconnect the Battery Cables before making other wiring connections.



**TO PREVENT SERIOUS INJURY FROM LEAKING BATTERY ACID:**  
Do not use a dirty, corroded or leaking battery.  
Only use a 12V automotive (or equivalent) battery, in good condition.

1. Plan a route for the wiring from the point of the vehicle where the Winch will be mounted, or used, to the battery. This route must be secure, out of the way of moving parts, road debris, or any possibility of being damaged by operation or maintenance of the vehicle. For example, you may wish to route the wires under the vehicle, attaching it to the frame using suitable fasteners. Do not attach the wires to the exhaust system, drive shaft, emergency brake cable, fuel line, or any other components which may damage the wiring through heat or motion, or create a fire hazard.
2. If you drill through the bumper or any part of the body to route the wires, be sure to install a rubber grommet in the hole to prevent fraying of the wires at that point.
3. Route the cables from the Receiver to the battery and from the Receiver to the Winch, following the precautions discussed earlier.
4. Attach the wires from the Receiver to the terminals on the Winch. Refer to Figure E.
5. Attach the red cable from the Circuit Breaker to the positive terminal on the battery. Refer to Figure E.
6. Attach the long black cable from the Receiver directly to the negative terminal of the battery. Refer to Figure E.

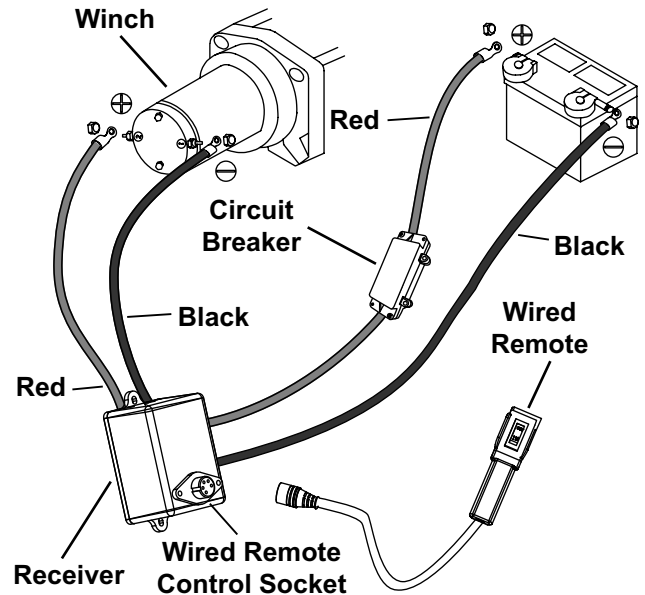

Figure E: Wiring Connections

**Note:** The attachment of the Motor Cables to the terminals on the Winch determines the operation of the Remote's button. After the unit is mounted and powered, check the direction of the Power In and Power Out on the Remote button. To change the direction on the Remote, disconnect the battery cables from the battery, switch the Motor Cable connections on the Motor Assembly, then reconnect the battery cables.

## Preparing the Wire Rope

1. The Wire Rope must be properly coiled under tension to be able to support a load without damage.
2. Uncoil the Wire Rope, except for 5 full wraps.
3. Recoil the Wire Rope back into the Winch under at least 500 lb. of tension.



## Operation



Read the **ENTIRE IMPORTANT SAFETY INFORMATION** section at the beginning of this manual including all text under subheadings therein before set up or use of this product. The instructions that follow are basic guidelines only and cannot cover all situations encountered during use. The operator and assistants must carefully plan usage to prevent accidents.

## Clutch Operation

**CAUTION!** Do not adjust the clutch unless there is no load on the Wire Rope.

1. The position of the pin in the shaft determines whether the clutch is engaged or not.

Shaft  
Pin

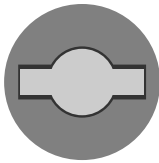

If the pin rests **in the groove in the drum** the clutch is **engaged**.

Drum  
End

Shaft  
Pin

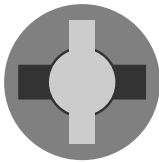

If the pin rests **on top of the end of the drum** the clutch is **released**.

Drum  
End

2. To change clutch positions:
  - a. Pull clutch handle out.
  - b. Turn it 90° while it is pulled out, then release it.

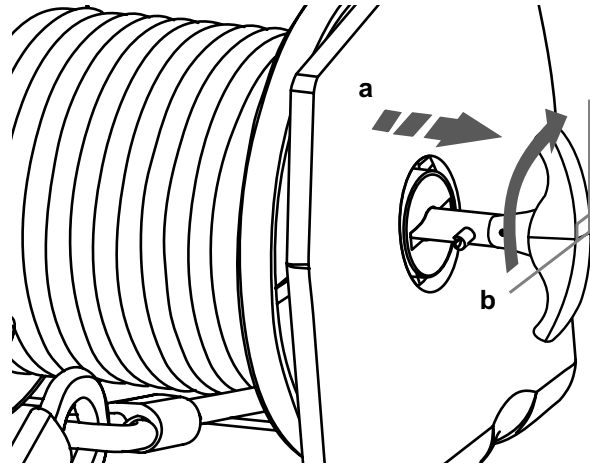

Figure F: Clutch operation

## Remote Control Instructions

**WARNING!** Only operate the Winch while the Winch, line, and load are in view. Make sure that there are no bystanders nearby.

To prevent serious injury from accidental starting, turn off remote after every use.

### Wired Operation

1. To use the Wired Remote Control, connect the Remote Control Cable to the Remote Control Socket on the Receiver. Refer to Figure E.
2. With the Clutch Handle in the Engaged position, press IN on the Rocker Switch to retract the Wire Rope.
3. Press OUT on the Rocker Switch to extend the Wire Rope out.

### Wireless Operation

1. Activate the Wireless Remote by pressing the ON/OFF button for 3 seconds until LED lights up.
2. Press EXTEND or RETRACT to operate Winch.
3. To turn off the Wireless Remote, keep pressing the ON/OFF button for 3 seconds until LED turns off. The Wireless Remote will automatically power off after 2 minutes of inactivity.

# Basic Operation

SAFETY

**Note:** If a winch is to be used to pull a vehicle, it should optimally be rated to a single line pull at least twice the vehicle's weight.

1. Examine the Wire Rope. Do not use the Winch if the Wire Rope is frayed, kinked or damaged.
2. Fully charge the vehicle's battery.
3. Check the Winch's electrical connections. All connections must be tight and clean.
4. Put the vehicle's transmission in Neutral.
5. If the vehicle where the Winch is mounted is not supposed to be moved, engage the emergency brake and block the wheels using wheel chocks (sold separately).
6. To pull out the Wire Rope, move the Clutch Handle to the Released position—see instructions for your Winch model under the *Clutch Operation* section. Slide the loop of the Hook Strap over the Hook, then pull on the Hook Strap to pull out the Wire Rope. **WARNING! TO PREVENT SERIOUS INJURY: Leave at least five full turns of Wire Rope on the drum.**
7. Hook onto the object using a pulling point, tow strap, tree strap, or chain. See Figure G. Shackle not shown between tree strap and hook.

SETUP

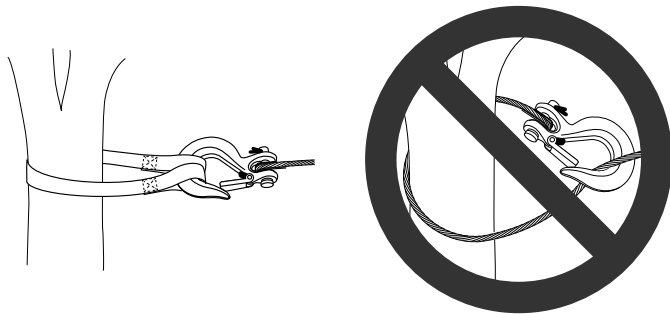

**Figure G: Using a strap anchor point**



**Do not wrap the Wire Rope around the object and hook onto the wire rope itself.**

This can damage the object being pulled, and kink or fray the Wire Rope.

OPERATION

MAINTENANCE

8. Attachment point must be centered in loop of hook and the hook's safety clasp must be fully closed. See Figure H.

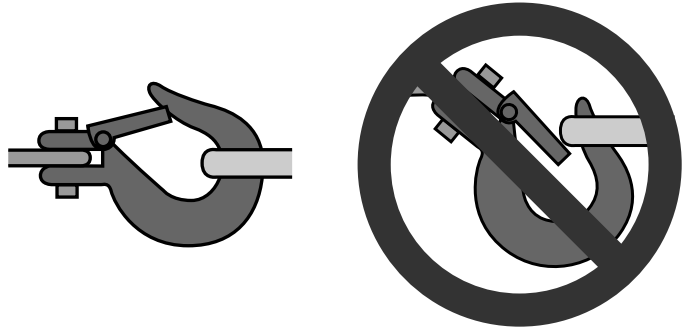

**Figure H: Correct and incorrect hook attachment**

9. **Do not use a Recovery Strap while winching.** They are designed to stretch and can suddenly whip back towards the operator during a winching operation.
10. Place a heavy blanket or winch damper (sold separately) over the Wire Rope span 6 feet from the hook to help absorb the force released if the Wire Rope breaks.

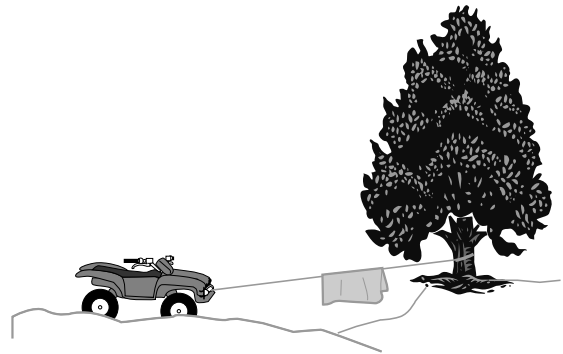

**Figure A: Whiplash Dampening Blanket or Winch Damper**

11. Move the Clutch Handle to the Engaged position. See the instructions for your Winch model under *Clutch Operation* on page 9.

**WARNING! TO PREVENT SERIOUS INJURY:** Do not allow anyone to stand near the Wire Rope, or in line with the Wire Rope behind the Winch while it is under power. If the Wire Rope should slip or break, it can suddenly whip back towards the Winch, causing a hazard for anyone in the area. Stand well to the side while winching.

## Double Line Rigging

- a. A double line system should be used whenever possible. It reduces the load on the Winch, allowing it to work longer with less heat buildup. It reduces load on the Winch in two ways:
- It utilizes the lower layers of wire rope that have higher capacity, and
  - It halves the load on the Winch through pulley action.
- b. Connect the wire rope for a double line system as shown in Figure I below. Use a snatch block (sold separately) properly rated for the load to be pulled and designed to be operated with this Winch's wire rope.



Figure I: Double Line setup

- c. Loop the wire rope around the snatch block and connect to another part of the vehicle's chassis or to a separate anchor point. **Do not anchor the Wire Rope back to the Winch or winch mount.**

**Note:** If anchoring the winching vehicle, only attach the anchor line to the front of the vehicle. If the anchor line is attached to the rear of the vehicle, the vehicle's frame may be damaged by the forces exerted by winching.

### **WARNING! TO PREVENT SERIOUS INJURY AND DEATH:**

Operate the Winch only while you have a clear view of the Winch, wire rope and entire winching operation. Stop winching if your view becomes obstructed.

12. Operate the controls briefly to ensure they work properly.
- a. For the Wired Remote Control:
- The IN position should retract the winch cable.
  - The OUT position should power out the cable.
- b. For the Wireless Remote Control:
- Activate the Wireless Remote by pressing the ON/OFF button for 3 seconds until LED lights up.
  - The retract button should retract the winch cable.
  - The extend button should power out the cable.

If operation is reversed, the power cables may be connected backwards. Correct any such issue before use.

13. When it is safe to do so, use the power switch on the Controller to retract the Wire Rope, and winch the item as desired. **Do not power the hook all the way into the fairlead to prevent damage.**
14. Do not operate the Winch at extreme angles. Do not exceed the angles shown in Figure B for a roller fairlead. For a hawse fairlead, the angle should be as close to straight as possible.

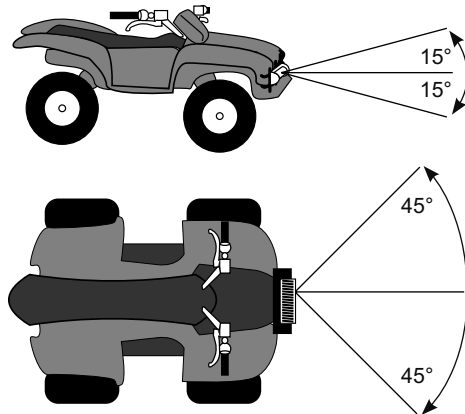

Figure B: Roller Fairlead Maximum Winching Angles

15. If the object to be pulled must be pulled at an angle in relation to the Winch, use a snatch block (sold separately) and an anchor point directly in front of the Winch, as shown in Figure C, to keep the Wire Rope pull straight.

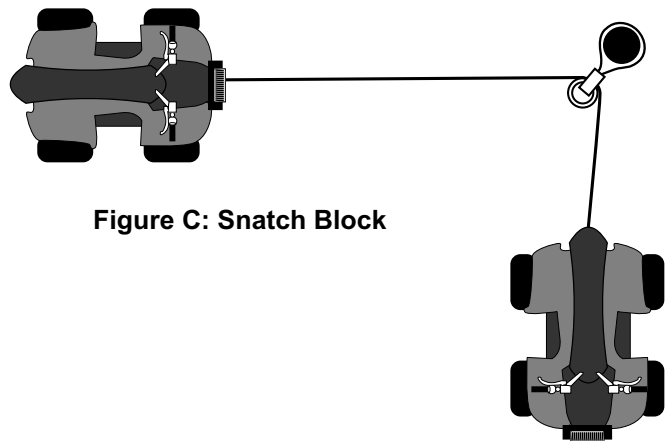

Figure C: Snatch Block

16. **WARNING! TO PREVENT SERIOUS INJURY:** Stop the Winch and release tension on the Wire Rope before moving the blanket or winch damper placed on it.
17. Do not continue use of the Winch until the battery is completely run down.
18. When possible, keep the engine running while using this Winch, to continually recharge the battery and prevent the battery from being drained so much that the vehicle cannot start. However, exercise extreme caution when working around a running vehicle and **ONLY** operate a vehicle in an outdoor area.

**CAUTION!** Do not use the Winch in a constant duty application, it is designed for **INTERMITTENT USE ONLY**. Keep the duration of the pulling job as short as possible. If the motor becomes very hot to the touch, stop and let it cool down for several minutes. Do not pull for more than one minute at or near the rated load. Do not maintain power to the Winch if the motor stalls. Double Line Rigging will help prevent overloading and should be used whenever practical. See *Double Line Rigging* on page 11.

19. When finished pulling the load, reverse the direction of the Winch just enough to release tension on the Wire Rope so that you can unfasten the Hook from the load and reel in the Wire Rope.

**CAUTION!** Do not power the Hook all the way into the Fairlead to prevent damage.

20. Press and hold the ON/OFF button on the Wireless Remote for 3 seconds to turn the Remote off. The indicator light on the Remote will turn off.
21. If using the Wired Remote Control, disconnect the Remote Control Cable from the Remote Control Socket on the Receiver after use.

**WARNING!** To prevent serious injury from accidental operation, disconnect the red Circuit Breaker cable from the positive terminal on the battery after use.

## Duty Cycle (Duration of Use)

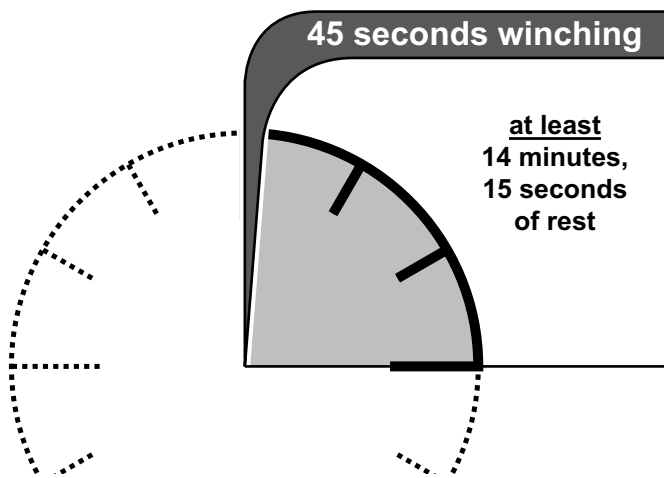

**Avoid damage to the Winch by not winching for more than the prescribed duty cycle time.**

The Duty Cycle defines the amount of time, within a 15 minute period, during which a Winch can operate at its maximum capacity without overheating. For example, this Winch with a 5% duty cycle at its maximum load must be allowed to rest for at least 14 minutes, 15 seconds after every 45 seconds of continuous operation. Failure to carefully observe duty cycle limitations can easily over-stress a Winch contributing to premature Winch failure.

### FCC STATEMENT

Caution: The user is cautioned that changes or modifications not expressly approved by the party responsible for compliance could void the user's authority to operate the equipment.

This device complies with Part 15 of the FCC Rules. Operation is subject to the following two conditions: (1) this device may not cause harmful interference, and (2) this device must accept any interference received, including interference that may cause undesired operation.

Note: This equipment has been tested and found to comply with the limits for a Class B digital device, pursuant to Part 15 of the FCC Rules. These limits are designed to provide reasonable protection against harmful interference in a residential installation. This equipment generates, uses and can radiate radio frequency energy and, if not installed and used in accordance with the instructions, may cause harmful interference to radio communications. However, there is no guarantee that interference will not occur in a particular installation.

If this equipment does cause harmful interference to radio or television reception, which can be determined by turning the equipment off and on, the user is encouraged to try to correct the interference by one or more of the following measures:

- Re-orient or relocate the receiving antenna.
- Increase the separation between the equipment and receiver.
- Connect the equipment into an outlet on a circuit different from that to which the receiver is connected
- Consult the dealer or an experienced radio/TV technician for help

## Maintenance and Servicing



Procedures not specifically explained in this manual must be performed only by a qualified technician.

### **! WARNING**



**TO PREVENT SERIOUS INJURY FROM ACCIDENTAL OPERATION:**

Disconnect the Battery Cables before performing any inspection, maintenance, or cleaning procedures.

**TO PREVENT SERIOUS INJURY FROM WINCH FAILURE:**

Do not use damaged equipment. If abnormal noise or vibration occurs, have the problem corrected before further use.

## Cleaning, Maintenance, and Lubrication

- BEFORE EACH USE**, inspect the general condition of the Winch. Check for:
  - loose hardware
  - misalignment or binding of moving parts
  - cracked or broken parts
  - damaged electrical wiring
  - corroded or loose terminals
  - any other condition that may affect its safe operation.
- AFTER USE**, wipe external surfaces of the Winch with clean cloth.
- Lubricate the Wire Rope occasionally with a light oil.
- The Winch's internal mechanism is permanently lubricated. Do not open the housing. However, if the Winch is submerged, it should be opened, dried, and re-lubricated by a qualified technician as soon as possible to prevent corrosion.

Examine the Wire Rope. Do not use the Winch if the Wire Rope is frayed, kinked or damaged.

## Wire Rope Replacement

- Move Clutch Handle to the released (freespool) position. Refer to *Clutch Operation* on page 9.
- Extend the Wire Rope to its full length, noting how the existing Wire Rope is connected to the inside of the drum.
- Remove old Wire Rope and attach new assembly.
- CAUTION!** Do not replace with inferior wire rope. Only use a wire rope rated to the same rating cited on the specification chart or better.
- Retract Wire Rope onto Wire Rope drum being careful not to allow kinking. Refer to instructions for tensioning the Wire Rope under *Preparing the Wire Rope* on page 8.
- Test Electric Winch for proper operation.

## Wireless Remote Control Battery Replacement

- Remove screws from battery cover on back of Wireless Remote.
- Remove battery cover carefully.
- Remove used batteries from unit and replace with same. Dispose of used batteries in accordance with all applicable local, state and federal laws.
- Replace battery cover and tighten screws securely.

**Note:** Position batteries in proper polarity.

# Troubleshooting

SAFETY

SETUP

OPERATION

MAINTENANCE

Problem	Possible Causes	Likely Solutions
Motor overheats.	<ol style="list-style-type: none"> <li>1. Incorrect power cords.</li> <li>2. Winch running time too long.</li> </ol>	<ol style="list-style-type: none"> <li>1. Use only supplied power cords.</li> <li>2. Allow Winch to cool down periodically.</li> </ol>
Motor does not turn on.	<ol style="list-style-type: none"> <li>1. Remote batteries dead.</li> <li>2. Loose battery cable connections.</li> <li>3. Vehicle battery needs charging.</li> <li>4. Solenoid malfunctioning.</li> <li>5. Remote damaged.</li> <li>6. Defective motor.</li> <li>7. Water has entered motor.</li> <li>8. Internal damage or wear.</li> </ol>	<ol style="list-style-type: none"> <li>1. Replace Remote batteries.</li> <li>2. Tighten nuts on all cable connections.</li> <li>3. Fully charge battery.</li> <li>4. Tap solenoid to loosen contacts. Apply 12 volts to coil terminals directly. A clicking indicates proper activation.</li> <li>5. Replace Remote.</li> <li>6. Check for voltage at armature port with Switch pressed. If voltage is present, replace motor.</li> <li>7. Allow to drain and dry. Run in short bursts without load until completely dry.</li> <li>8. Have technician service Winch.</li> </ol>
Motor runs but Wire Rope drum does not turn.	Clutch not engaged.	Move the Clutch Handle to the Engaged position. If problem persists, a qualified technician needs to check and repair.
Motor runs slowly or without normal power.	<ol style="list-style-type: none"> <li>1. Insufficient current or voltage.</li> <li>2. Loose or corroded battery cable connections.</li> <li>3. Incorrect power cords.</li> </ol>	<ol style="list-style-type: none"> <li>1. Battery weak, recharge. Run Winch with vehicle motor running.</li> <li>2. Clean, tighten, or replace.</li> <li>3. Use only supplied power cords.</li> </ol>
Motor runs in one direction only.	<ol style="list-style-type: none"> <li>1. Defective or stuck solenoid.</li> <li>2. Remote damaged.</li> </ol>	<ol style="list-style-type: none"> <li>1. Tap solenoid to loosen contacts. Repair or replace solenoid.</li> <li>2. Replace Remote.</li> </ol>
 <p><b>Follow all safety precautions whenever diagnosing or servicing the tool. Disconnect power supply before service.</b></p>		

## PLEASE READ THE FOLLOWING CAREFULLY

THE MANUFACTURER AND/OR DISTRIBUTOR HAS PROVIDED THE PARTS LIST AND ASSEMBLY DIAGRAM IN THIS MANUAL AS A REFERENCE TOOL ONLY. NEITHER THE MANUFACTURER OR DISTRIBUTOR MAKES ANY REPRESENTATION OR WARRANTY OF ANY KIND TO THE BUYER THAT HE OR SHE IS QUALIFIED TO MAKE ANY REPAIRS TO THE PRODUCT, OR THAT HE OR SHE IS QUALIFIED TO REPLACE ANY PARTS OF THE PRODUCT. IN FACT, THE MANUFACTURER AND/OR DISTRIBUTOR EXPRESSLY STATES THAT ALL REPAIRS AND PARTS REPLACEMENTS SHOULD BE UNDERTAKEN BY CERTIFIED AND LICENSED TECHNICIANS, AND NOT BY THE BUYER. THE BUYER ASSUMES ALL RISK AND LIABILITY ARISING OUT OF HIS OR HER REPAIRS TO THE ORIGINAL PRODUCT OR REPLACEMENT PARTS THERETO, OR ARISING OUT OF HIS OR HER INSTALLATION OF REPLACEMENT PARTS THERETO.

## Parts List and Assembly Diagram

Part	Description	Qty.
1	Clutch Knob	1
2	Drum Support	1
3	Drum	1
4	Tension Plate	1
5	Lock Nut M5	2
6	Spindle Assembly	1
7	Cross-head Screw	4
8	Bushing	1
9	Gearbox Cover	1
10	Gear Carrier	1
11	Washer	1
12	Planetary Gear	1
13	Ring Gear	1
14	Spacer	1

Part	Description	Qty.
15	Motor Assembly	1
16	Bolt	2
17	Mounting Bracket	1
18	Solenoid Assembly	1
19	Roller Fairlead	1
20	Steel cable (5/32"×50')	1
21	Hardware Kits	1
22	Screw	2
23	Remote Control	1
24	5/16" Hook	1
25	Terminal Sleeve	2
26	1/2" Shackle	1
27	Hook Strap	1

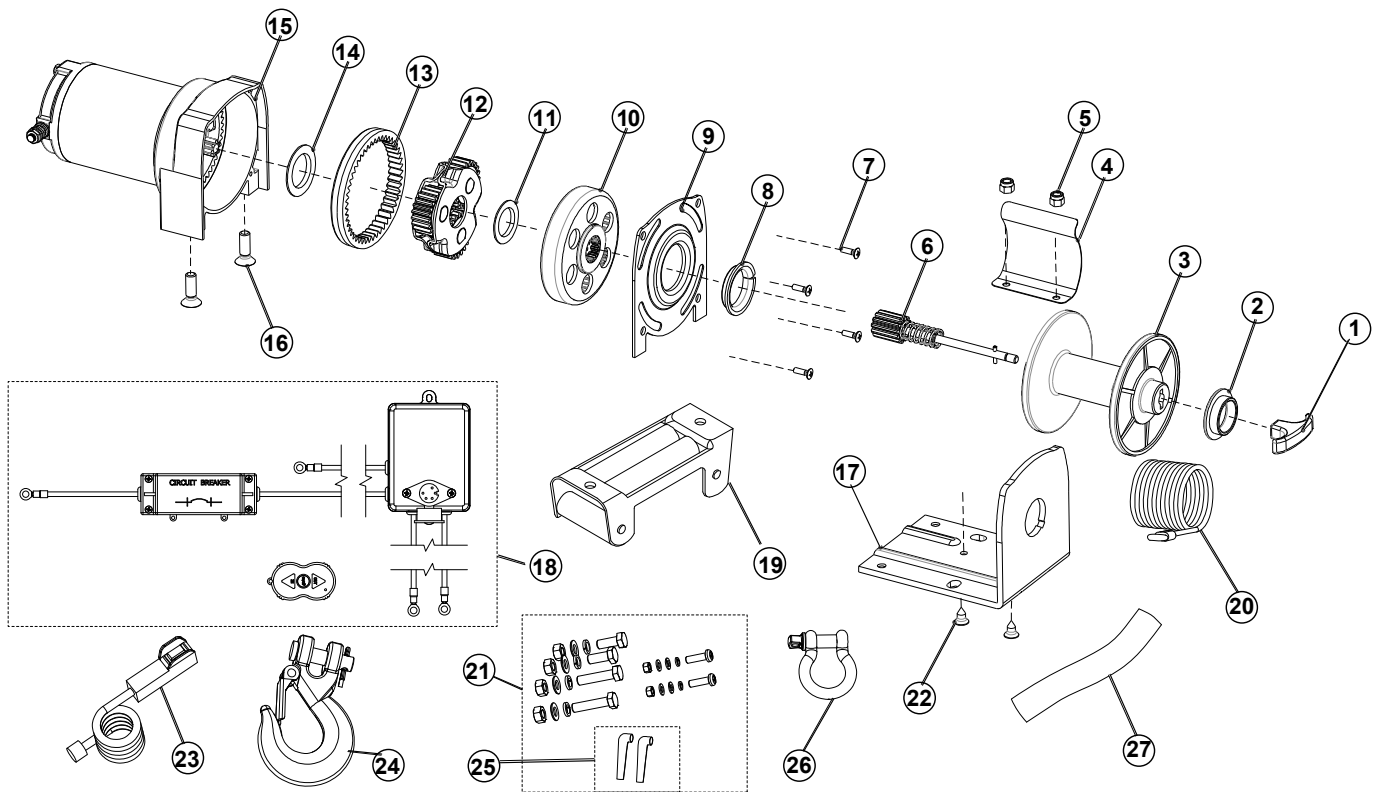

Record Product's Serial Number Here: \_\_\_\_\_

**Note:** If product has no serial number, record month and year of purchase instead.

**Note:** Some parts are listed and shown for illustration purposes only, and are not available individually as replacement parts. Specify UPC 193175444363 when ordering parts.  
Item 56258

**For technical questions, please call 1-888-866-5797.**

## Limited 90 Day Warranty

Harbor Freight Tools Co. makes every effort to assure that its products meet high quality and durability standards, and warrants to the original purchaser that this product is free from defects in materials and workmanship for the period of 90 days from the date of purchase. This warranty does not apply to damage due directly or indirectly, to misuse, abuse, negligence or accidents, repairs or alterations outside our facilities, criminal activity, improper installation, normal wear and tear, or to lack of maintenance. We shall in no event be liable for death, injuries to persons or property, or for incidental, contingent, special or consequential damages arising from the use of our product. Some states do not allow the exclusion or limitation of incidental or consequential damages, so the above limitation of exclusion may not apply to you. THIS WARRANTY IS EXPRESSLY IN LIEU OF ALL OTHER WARRANTIES, EXPRESS OR IMPLIED, INCLUDING THE WARRANTIES OF MERCHANTABILITY AND FITNESS.

To take advantage of this warranty, the product or part must be returned to us with transportation charges prepaid. Proof of purchase date and an explanation of the complaint must accompany the merchandise. If our inspection verifies the defect, we will either repair or replace the product at our election or we may elect to refund the purchase price if we cannot readily and quickly provide you with a replacement. We will return repaired products at our expense, but if we determine there is no defect, or that the defect resulted from causes not within the scope of our warranty, then you must bear the cost of returning the product.

This warranty gives you specific legal rights and you may also have other rights which vary from state to state.

The logo for BADLAND is rendered in a bold, black, blocky font. Each letter is thick and has a slightly irregular, industrial feel. A small registered trademark symbol (®) is located at the bottom right corner of the final letter 'D'.

26541 Agoura Road • Calabasas, CA 91302 • 1-888-866-5797