

Owner's Manual & Safety Instructions

Save This Manual Keep this manual for the safety warnings and precautions, assembly, operating, inspection, maintenance and cleaning procedures. Write the product's serial number in the back of the manual near the assembly diagram (or month and year of purchase if product has no number). Keep this manual and the receipt in a safe and dry place for future reference.

19h

Bauer™

1915H-B

20v/120v

HYBRID

HYPERMAX™ LITHIUM

**For Best Results,
Use 3.0 Amp Hour Battery
(Sold Separately)**

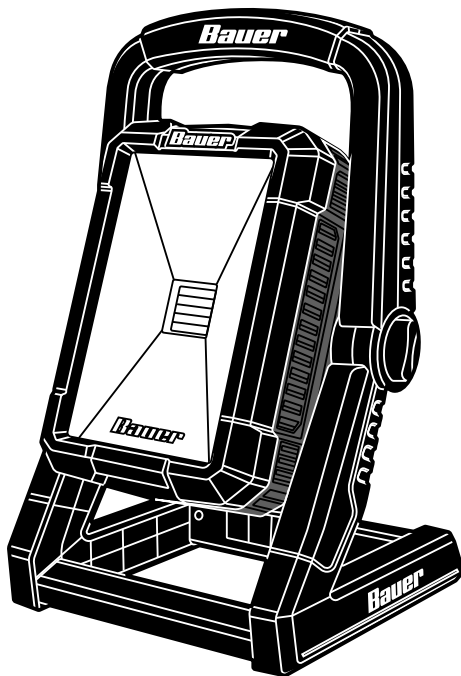

DUAL POWER WORK LIGHT

Visit our website at: <http://www.harborfreight.com>
Email our technical support at: productsupport@harborfreight.com

56527

When unpacking, make sure that the product is intact and undamaged. If any parts are missing or broken, please call 1-888-866-5797 as soon as possible.

Copyright© 2019 by Harbor Freight Tools®. All rights reserved.

No portion of this manual or any artwork contained herein may be reproduced in any shape or form without the express written consent of Harbor Freight Tools. Diagrams within this manual may not be drawn proportionally. Due to continuing improvements, actual product may differ slightly from the product described herein. Tools required for assembly and service may not be included.

⚠WARNING

Read this material before using this product.
Failure to do so can result in serious injury.
SAVE THIS MANUAL.

Table of Contents

Safety	2	Maintenance	10
Specifications	8	Parts List and Diagram	11
Setup	8	Warranty	12
Operation	9		



WARNING SYMBOLS AND DEFINITIONS

	This is the safety alert symbol. It is used to alert you to potential personal injury hazards. Obey all safety messages that follow this symbol to avoid possible injury or death.
	Indicates a hazardous situation which, if not avoided, will result in death or serious injury.
	Indicates a hazardous situation which, if not avoided, could result in death or serious injury.
	Indicates a hazardous situation which, if not avoided, could result in minor or moderate injury.
	Addresses practices not related to personal injury.

IMPORTANT SAFETY INFORMATION

General Power Tool Safety Warnings

WARNING

Read all safety warnings and all instructions.

Failure to follow the warnings and instructions may result in electric shock, fire and/or serious injury.

Save all warnings and instructions for future reference.

The term "power tool" in the warnings refers to your battery-operated (cordless) mains-operated (corded) power tool.

Work Area Safety

- 1. Keep work area clean and well lit.**
Cluttered or dark areas invite accidents.
- 2. Do not operate power tools in explosive atmospheres, such as in the presence of flammable liquids, gases or dust.** *Power tools create sparks which may ignite the dust or fumes.*
- 3. Keep children and bystanders away while operating a power tool.**
Distractions can cause you to lose control.

Electrical Safety

- Power tool plugs must match the outlet. Never modify the plug in any way. Do not use any adapter plugs with grounded power tools.** *Unmodified plugs and matching outlets will reduce risk of electric shock.*
- Avoid body contact with grounded surfaces such as pipes, radiators, ranges and refrigerators.** *There is an increased risk of electric shock if your body is grounded.*
- Do not expose power tools to rain or wet conditions.** *Water entering a power tool will increase the risk of electric shock.*
- Do not abuse the cord. Never use the cord for carrying, pulling or unplugging the power tool. Keep cord away from heat, oil, sharp edges or moving parts.** *Damaged or entangled cords increase the risk of electric shock.*
- When operating a power tool outdoors, use an extension cord suitable for outdoor use.** *Use of a cord suitable for outdoor use reduces the risk of electric shock.*
- If operating a power tool in a damp location is unavoidable, use a Ground Fault Circuit Interrupter (GFCI) protected supply.** *Use of a GFCI reduces the risk of electric shock.*
- Do not expose power tools to rain or wet conditions.** *Water entering a power tool will increase the risk of electric shock.*

Personal Safety

- Stay alert, watch what you are doing and use common sense when operating a power tool. Do not use a power tool while you are tired or under the influence of drugs, alcohol or medication.** *A moment of inattention while operating power tools may result in serious personal injury.*
- Use personal protective equipment. Always wear eye protection.** *Protective equipment such as dust mask, non-skid safety shoes, hard hat, or hearing protection used for appropriate conditions will reduce personal injuries.*
- Prevent unintentional starting. Ensure the Switch is in the off-position before connecting to power source, picking up or carrying the tool.** *Carrying power tools with your finger on the Switch or energizing power tools that have the Switch on invites accidents.*
- Do not overreach. Keep proper footing and balance at all times.** *This enables better control of the power tool in unexpected situations.*
- Dress properly. Do not wear loose clothing or jewelry. Keep your hair, clothing and gloves away from moving parts.** *Loose clothes, jewelry or long hair can be caught in moving parts.*
- If devices are provided for the connection of dust extraction and collection facilities, ensure these are connected and properly used.** *Use of dust collection can reduce dust-related hazards.*
- Only use safety equipment that has been approved by an appropriate standards agency.** *Unapproved safety equipment may not provide adequate protection. Eye protection must be ANSI-approved and breathing protection must be NIOSH-approved for the specific hazards in the work area.*

Power Tool Use and Care

- Do not force the power tool. Use the correct power tool for your application.** *The correct power tool will do the job better and safer at the rate for which it was designed.*
- Do not use the power tool if the Switch does not turn it on and off.** *Any power tool that cannot be controlled with the Switch is dangerous and must be repaired.*
- Disconnect the plug from the power source battery pack from the power tool before making any adjustments, changing accessories, or storing power tools.** *Such preventive safety measures reduce the risk of starting the power tool accidentally.*
- Store idle power tools out of the reach of children and do not allow persons unfamiliar with the power tool or these instructions to operate the power tool.** *Power tools are dangerous in the hands of untrained users.*
- Maintain power tools. Check for misalignment or binding of moving parts, breakage of parts and any other condition that may affect the power tool's operation. If damaged, have the power tool repaired before use.** *Many accidents are caused by poorly maintained power tools.*
- Keep cutting tools sharp and clean.** *Properly maintained cutting tools with sharp cutting edges are less likely to bind and are easier to control.*

7. Use the power tool, accessories and tool bits etc. in accordance with these instructions, taking into account the working conditions and the work to be performed. *Use of the power tool for operations different from those intended could result in a hazardous situation.*

Battery tool use and care

1. **Recharge only with the charger specified by the manufacturer.** *A charger that is suitable for one type of battery pack may create a risk of fire when used with another battery pack.*
2. **Use power tools only with specifically designated battery packs.** *Use of any other battery packs may create a risk of injury and fire.*
3. **When battery pack is not in use, keep it away from other metal objects, like paper clips, coins, keys, nails, screws or other small metal objects, that can make a connection from one terminal to another.** *Shorting the battery terminals together may cause burns or a fire.*
4. **Under abusive conditions, liquid may be ejected from the battery; avoid contact. If contact accidentally occurs, flush with water. If liquid contacts eyes, additionally seek medical help.** *Liquid ejected from the battery may cause irritation or burns.*

Service

Have your power tool serviced by a qualified repair person using only identical replacement parts. *This will ensure that the safety of the power tool is maintained.*

Flashlight Safety Warnings

WARNING - When using flashlights or lanterns, additional precautions should always be followed, including the following:

1. To reduce the risk of injury, close supervision is necessary when a product is used near children.
2. Do not use in the rain.
3. To reduce the risk of electrical shock, do not put Light in water or other liquid. Do not place or store product where it can fall or be pulled into a tub or sink.
4. To reduce the risk of injury, do not stare at operating lamp. Serious eye injury could occur.
5. Maintain labels and nameplates on the tool. These carry important safety information. If unreadable or missing, contact Harbor Freight Tools for a replacement.
6. Avoid unintentional starting. Prepare to begin work before turning on the tool.
7. Do not leave the tool unattended when it is plugged into an electrical outlet the Battery Pack is connected. Turn off the tool, and unplug it from its electrical outlet remove the Battery Pack before leaving.
8.  The battery Charger gets hot during use. The Charger's heat can build up to unsafe levels and create a fire hazard if it does not receive adequate ventilation, due to an electrical fault, or if it is used in a hot environment.
Do not place the Charger on a flammable surface. Do not obstruct any vents on the Charger. **Especially avoid placing the Charger on carpets and rugs; they are not only flammable, but they also obstruct vents under the Charger.** Place the Charger on a stable, solid, nonflammable surface (such as a stable metal workbench or concrete floor) at least 1 foot away from all flammable objects, such as drapes or walls. Keep a fire extinguisher and a smoke detector in the area. Frequently monitor the Charger and Battery Pack while charging.
9. The warnings, precautions, and instructions discussed in this instruction manual cannot cover all possible conditions and situations that may occur.
It must be understood by the operator that common sense and caution are factors which cannot be built into this product, but must be supplied by the operator.

Lithium Battery Safety Warnings



**LITHIUM BATTERIES STORE
A LARGE AMOUNT OF ENERGY AND
WILL VENT FIRE OR EXPLODE IF MISTREATED:**



1. **Keep Battery Pack dry.**
2. **DO NOT DO ANY OF THE FOLLOWING TO THE BATTERY PACK:**
 - a. **Open,**
 - b. **Drop,**
 - c. **Short-circuit,**
 - d. **Puncture,**
 - e. **Incinerate, or**
 - f. **Expose to temperatures greater than 140°F.**
3. Charge Battery Pack only according to its Charger's instructions.
4. Inspect Battery Pack before every use; do not use or charge if damaged.



SAVE THESE INSTRUCTIONS.

⚠ WARNING



TO PREVENT ELECTRIC SHOCK AND DEATH FROM INCORRECT GROUNDING WIRE CONNECTION:

Check with a qualified electrician if you are in doubt as to whether the outlet is properly grounded. Do not modify the power cord plug provided with the tool charger. Never remove the grounding prong from the plug. Do not use the tool charger if the power cord or plug is damaged. If damaged, have it repaired by a service facility before use. If the plug will not fit the outlet, have a proper outlet installed by a qualified electrician.

Grounded Tools: Tools with Three Prong Plugs

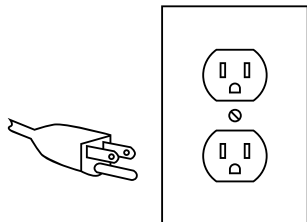

3-Prong Plug and Outlet

1. Tools marked with "Grounding Required" have a three wire cord and three prong grounding plug. The plug must be connected to a properly grounded outlet. If the tool should electrically malfunction or break down, grounding provides a low resistance path to carry electricity away from the user, reducing the risk of electric shock. (See 3-Prong Plug and Outlet.)

2. The grounding prong in the plug is connected through the green wire inside the cord to the grounding system in the tool. The green wire in the cord must be the only wire connected to the tool's grounding system and must never be attached to an electrically "live" terminal. (See 3-Prong Plug and Outlet.)
3. The tool must be plugged into an appropriate outlet, properly installed and grounded in accordance with all codes and ordinances. The plug and outlet should look like those in the preceding illustration. (See 3-Prong Plug and Outlet.)

Double Insulated Tools: Tools with Two Prong Plugs

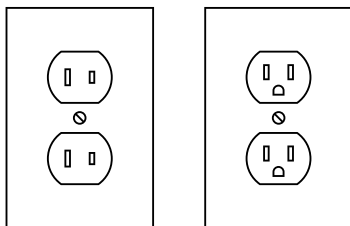

Outlets for 2-Prong Plug

1. Tools marked "Double Insulated" do not require grounding. They have a special double insulation system which satisfies OSHA requirements and complies with the applicable standards of Underwriters Laboratories, Inc., the Canadian Standard Association, and the National Electrical Code.
2. Double insulated tools may be used in either of the 120 volt outlets shown in the preceding illustration. (See Outlets for 2-Prong Plug.)

Extension Cords

Note: Extension cords must not be used with this item's Charger.

1. **Grounded** tools require a three wire extension cord. **Double Insulated** tools can use either a two or three wire extension cord.
2. As the distance from the supply outlet increases, you must use a heavier gauge extension cord. Using extension cords with inadequately sized wire causes a serious drop in voltage, resulting in loss of power and possible tool damage. (See Table A.)







- The smaller the gauge number of the wire, the greater the capacity of the cord. For example, a 14 gauge cord can carry a higher current than a 16 gauge cord. **(See Table A.)**
- When using more than one extension cord to make up the total length, make sure each cord contains at least the minimum wire size required. **(See Table A.)**
- If you are using one extension cord for more than one tool, add the nameplate amperes and use the sum to determine the required minimum cord size. **(See Table A.)**
- If you are using an extension cord outdoors, make sure it is marked with the suffix "W-A" ("W" in Canada) to indicate it is acceptable for outdoor use.
- Make sure the extension cord is properly wired and in good electrical condition. Always replace a damaged extension cord or have it repaired by a qualified electrician before using it.



- Protect the extension cords from sharp objects, excessive heat, and damp or wet areas.

TABLE A: RECOMMENDED MINIMUM WIRE GAUGE FOR EXTENSION CORDS* (120/240 VOLT)					
NAMEPLATE AMPERES (at full load)	EXTENSION CORD LENGTH				
	25'	50'	75'	100'	150'
0 – 2.0	18	18	18	18	16
2.1 – 3.4	18	18	18	16	14
3.5 – 5.0	18	18	16	14	12
5.1 – 7.0	18	16	14	12	12
7.1 – 12.0	18	14	12	10	-
12.1 – 16.0	14	12	10	-	-
16.1 – 20.0	12	10	-	-	-

* Based on limiting the line voltage drop to five volts at 150% of the rated amperes.

Symbology

	Double Insulated
	Volts
	Alternating Current
	Amperes
n_0 xxxx/min.	No Load Revolutions per Minute (RPM)
	WARNING marking concerning Risk of Eye Injury. Wear ANSI-approved safety goggles with side shields.
	Read the manual before set-up and/or use.

	WARNING marking concerning Risk of Fire. Do not cover Charger ventilation ducts. Keep flammable objects away. Charge on fireproof surface only.
	WARNING marking concerning Risk of Electric Shock. Properly connect power cord to appropriate outlet. Properly connect Charger's power cord to appropriate outlet.
	WARNING marking concerning Risk of Explosion. Do not puncture, short, or open battery packs and do not charge damaged battery packs.

Specifications

Battery Rating	Bauer 20V Li-ion (sold separately)
Electrical Rating	120VAC / 60Hz / .28A

Setup - Before Use:



Read the **ENTIRE IMPORTANT SAFETY INFORMATION** section at the beginning of this manual including all text under subheadings therein before set up or use of this product.

Note: For additional information regarding the parts listed in the following pages, refer to *Parts List and Diagram* on page 11.

Functions



Operating Instructions



Read the **ENTIRE IMPORTANT SAFETY INFORMATION** section at the beginning of this manual including all text under subheadings therein before set up or use of this product.

Tool Set Up

Battery Charging

Charge battery before using this tool. Follow instructions included with battery charger (sold separately).

Operating Instructions

Choose Power Supply

1. **Battery Pack:** Insert fully charged Battery Pack into back of Work Light, making sure it clicks into place securely.
2. **120VAC Extension Cord:**
 - a. Remove Battery Pack from Work Light.
 - b. Connect the extension cord to the 120VAC Input on back of Work Light.
 - c. Plug the other end of the extension cord into a grounded 120VAC outlet.

Work Light Placement

CAUTION! Keep Work Light and cord out of walkways.

1. **Freestanding:** Place Work Light on a flat surface.
2. **Hook:**
 - a. Select a suitable location for hanging the Work Light. The Work Light must be hung from a sturdy mounting location able to support the weight of the Work Light and Battery.
 - b. Lift Hook from slot and hang carefully in selected location.
3. **Wall Mount:**

WARNING! Verify that installation surface has no hidden utility lines before drilling or driving screws.

WARNING! Do not install the Work Light directly into drywall.

- a. Select a suitable location for hanging the Work Light.
- b. Choose two adjacent studs. If drywall is present, use a stud finder (sold separately) and mark locations of studs.



Keyholes

Note: For other types of walls, use appropriate hardware.

4. Loosen Adjustment Knob, rotate Work Light to desired position, then tighten Adjustment Knob.

Operation

1. Press Power Button once for "high" light output. Press again for "low" light output. Press a third time to turn light off.
2. After use, remove Work Light from wood studs or Hook. Unplug or remove Battery Pack. Clean, then store the tool indoors out of children's reach.

USER-MAINTENANCE INSTRUCTIONS



Procedures not specifically explained in this manual must be performed only by a qualified technician.

WARNING

TO PREVENT SERIOUS INJURY FROM ACCIDENTAL OPERATION:

Make sure that the Switch is in the off-position and unplug the tool from its electrical outlet remove its Battery Pack before performing any procedure in this section.

Cleaning, Maintenance, and Lubrication

- BEFORE EACH USE**, inspect the general condition of the tool. Check for:
 - leaking, swollen, or cracked battery pack,
 - loose hardware,
 - misalignment or binding of moving parts,
 - damaged cord/electrical wiring,
 - cracked or broken parts, and
 - any other condition that may affect its safe operation.
- AFTER USE**, wipe external surfaces of the tool with clean cloth.
- Li-Ion BATTERY MUST BE RECYCLED OR DISPOSED OF PROPERLY.
Do not short, incinerate or open battery.
- Disconnect battery pack and store battery pack, charger, and tool in dry, indoor area out of reach of children and away from metal objects (i.e., paperclips, coins) to prevent shorting.

Troubleshooting

Problem	Possible Causes	Likely Solutions
Flashlight will not turn on.	<ol style="list-style-type: none">Cord not connected.No power at outlet.Tool's thermal reset breaker tripped (if equipped).Battery Pack not properly connected.Battery Pack not properly charged.Battery Pack burnt-out.	<ol style="list-style-type: none">Check that cord is plugged in.Check power at outlet. If outlet is unpowered, turn off tool and check circuit breaker. If breaker is tripped, make sure circuit is right capacity for tool and circuit has no other loads.Turn off tool and allow to cool. Press reset button on tool.Remove Battery Pack, make sure there are no obstructions, reinsert the Battery Pack according to its shape (it should only fit one way), and press firmly until the Battery Pack locks in place.Make sure Charger is connected and operating properly. Give enough time for Battery Pack to recharge properly.Dispose of old Battery Pack properly or recycle. Replace Battery Pack.



Follow all safety precautions whenever diagnosing or servicing the tool.
Disconnect Battery Pack and Charger power supply before service.

Record Product's Serial Number Here: _____

Note: If product has no serial number, record month and year of purchase instead.

Note: Some parts are listed and shown for illustration purposes only, and are not available individually as replacement parts.

PLEASE READ THE FOLLOWING CAREFULLY

THE MANUFACTURER AND/OR DISTRIBUTOR HAS PROVIDED THE PARTS LIST AND ASSEMBLY DIAGRAM IN THIS MANUAL AS A REFERENCE TOOL ONLY. NEITHER THE MANUFACTURER OR DISTRIBUTOR MAKES ANY REPRESENTATION OR WARRANTY OF ANY KIND TO THE BUYER THAT HE OR SHE IS QUALIFIED TO MAKE ANY REPAIRS TO THE PRODUCT, OR THAT HE OR SHE IS QUALIFIED TO REPLACE ANY PARTS OF THE PRODUCT. IN FACT, THE MANUFACTURER AND/OR DISTRIBUTOR EXPRESSLY STATES THAT ALL REPAIRS AND PARTS REPLACEMENTS SHOULD BE UNDERTAKEN BY CERTIFIED AND LICENSED TECHNICIANS, AND NOT BY THE BUYER. THE BUYER ASSUMES ALL RISK AND LIABILITY ARISING OUT OF HIS OR HER REPAIRS TO THE ORIGINAL PRODUCT OR REPLACEMENT PARTS THERETO, OR ARISING OUT OF HIS OR HER INSTALLATION OF REPLACEMENT PARTS THERETO.

Parts List and Diagram

Part	Description	Qty
1	Led Head Cover	1
2	Lens	1
3	Reflector	1
4	Screw	4
5	Screw	2
6	High Power COB Led	1
7	Heatsink	1
8	PCBA	1
9	Switch Cap	1
10	UI AC/DC Adapter	1
11	Contact Plate Holder	1
12	Screw	2
13	Screw Pressure	1
14	Bolt	1
15	Washer	1
16	Right Housing	1
17	O-Ring	4

Part	Description	Qty
18	Right Leg	1
19	Adjust Knob	1
20	Left Cover	1
21	Screw	14
22	Fixed Pin	1
23	Screw	6
24	Left Leg	1
25	Left Housing	1
26	Front Holder	1
27	Screw	2
28	Insert Block	1
29	End Holder	1
30	Fixed Shaft	1
31	Hook	1
32	Front Handle	1
33	End Handle	1

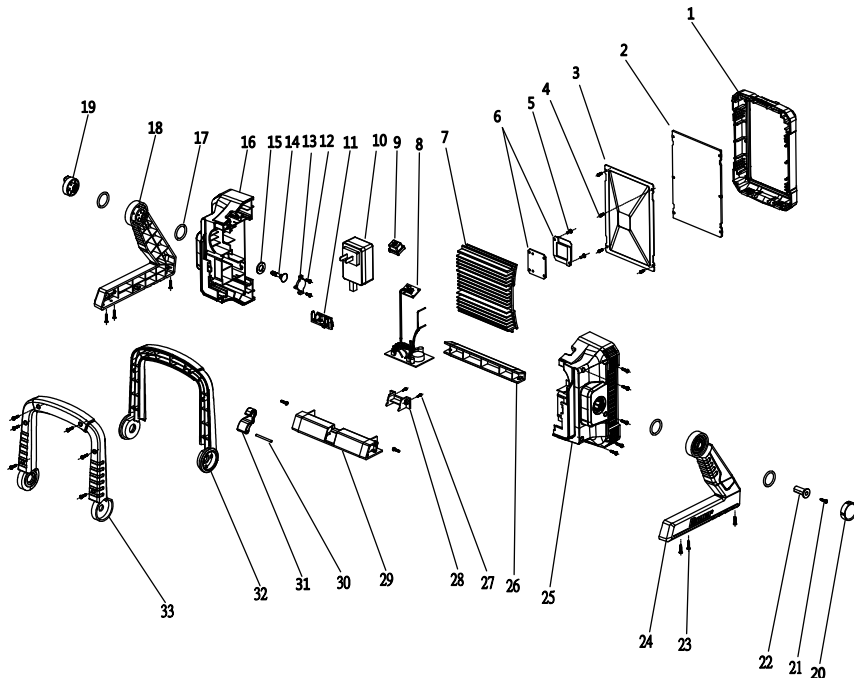

SAFETY

SETUP

OPERATION

MAINTENANCE

Limited 90 Day Warranty

Harbor Freight Tools Co. makes every effort to assure that its products meet high quality and durability standards, and warrants to the original purchaser that this product is free from defects in materials and workmanship for the period of 90 days from the date of purchase. This warranty does not apply to damage due directly or indirectly, to misuse, abuse, negligence or accidents, repairs or alterations outside our facilities, criminal activity, improper installation, normal wear and tear, or to lack of maintenance. We shall in no event be liable for death, injuries to persons or property, or for incidental, contingent, special or consequential damages arising from the use of our product. Some states do not allow the exclusion or limitation of incidental or consequential damages, so the above limitation of exclusion may not apply to you. THIS WARRANTY IS EXPRESSLY IN LIEU OF ALL OTHER WARRANTIES, EXPRESS OR IMPLIED, INCLUDING THE WARRANTIES OF MERCHANTABILITY AND FITNESS.

To take advantage of this warranty, the product or part must be returned to us with transportation charges prepaid. Proof of purchase date and an explanation of the complaint must accompany the merchandise. If our inspection verifies the defect, we will either repair or replace the product at our election or we may elect to refund the purchase price if we cannot readily and quickly provide you with a replacement. We will return repaired products at our expense, but if we determine there is no defect, or that the defect resulted from causes not within the scope of our warranty, then you must bear the cost of returning the product.

This warranty gives you specific legal rights and you may also have other rights which vary from state to state.

Bauer[™]

26541 Agoura Road • Calabasas, CA 91302 • 1-888-866-5797