

Owner's Manual & Safety Instructions

Save This Manual Keep this manual for the safety warnings and precautions, assembly, operating, inspection, maintenance and cleaning procedures. Write the product's serial number in the back of the manual near the assembly diagram (or month and year of purchase if product has no number). Keep this manual and the receipt in a safe and dry place for future reference.

201

CEN-TECH®

4-IN-1 PORTABLE JUMP PACK



IMPORTANT: YOU MUST CHARGE COMPLETELY BEFORE FIRST USE, AFTER EVERY JUMP START, AND EVERY 30 DAYS OR VOIDS WARRANTY.



Visit our website at: <http://www.harborfreight.com>
Email our technical support at: productsupport@harborfreight.com

56631

When unpacking, make sure that the product is intact and undamaged. If any parts are missing or broken, please call 1-888-866-5797 as soon as possible.

Copyright© 2020 by Harbor Freight Tools®. All rights reserved.
No portion of this manual or any artwork contained herein may be reproduced in any shape or form without the express written consent of Harbor Freight Tools. Diagrams within this manual may not be drawn proportionally. Due to continuing improvements, actual product may differ slightly from the product described herein. Tools required for assembly and service may not be included.

⚠ WARNING





Read this material before using this product. Failure to do so can result in serious injury. **SAVE THIS MANUAL.**

Table of Contents



Safety	2	Maintenance	10
Specifications	4	Parts List and Diagram	11
Setup	5	Warranty	12
Operation	8		

CEN-TECH®

WARNING SYMBOLS AND DEFINITIONS

	This is the safety alert symbol. It is used to alert you to potential personal injury hazards. Obey all safety messages that follow this symbol to avoid possible injury or death.
	Indicates a hazardous situation which, if not avoided, will result in death or serious injury.
	Indicates a hazardous situation which, if not avoided, could result in death or serious injury.
	Indicates a hazardous situation which, if not avoided, could result in minor or moderate injury.
	Addresses practices not related to personal injury.

V	Volts
~	Alternating Current
A	Amperes
CCA	Cold Cranking Amps
RC	Reserve Capacity
Ah	Ampere-hours

	WARNING marking concerning Risk of Eye Injury. Wear ANSI-approved splash-resistant safety goggles.
	Read the manual before set-up and/or use.
	WARNING marking concerning Risk of Fire. Follow connection procedure.

General Safety Warnings

⚠️ WARNING

Read all safety warnings and instructions.

Failure to follow the warnings and instructions may result in electric shock, fire and/or serious injury.

Save all warnings and instructions for future reference.

WARNING – RISK OF EXPLOSIVE GASES.

Working in vicinity of a lead-acid battery is dangerous. Batteries generate explosive gases during normal battery operation. For this reason, it is of utmost importance that you follow the instructions each time you use the Power Pack.

To reduce risk of battery explosion, follow these instructions and those published by battery manufacturer and manufacturer of any equipment you intend to use in vicinity of battery. Review cautionary marking on these products and on engine.

Work Area Safety

1. **Keep work area clean and well lit.**
Cluttered or dark areas invite accidents.
2. **Do not operate Power Pack in explosive atmospheres, such as in the presence of flammable liquids, gases or dust.**
The Power Pack can create sparks which may ignite the dust or fumes.
3. **Keep children and bystanders away while operating the Power Pack.**
Distractions can cause you to lose control.
4. **Store idle equipment.** *Always lock up tools and keep out of reach of children.*

Electrical Safety

1. **Do not drop a metal tool onto battery.** *It might spark or short-circuit battery or other electrical part that may cause explosion.*
2. **Do not operate if Power Pack has received a sharp blow, been dropped, or otherwise damaged in any way; take it to a qualified technician.**
3. **Do not leave Power Pack unattended while switched on.** *It could result in fire and property damage.*
4. **Do not expose to rain or wet conditions.** *Water entering the Power Pack will increase the risk of electric shock.*
5. **Do not use an extension cord with this item.**
6. **Use of an attachment not recommended or sold by the manufacturer may result in a risk of fire, electric shock, or injury to persons.**
7. **To reduce risk of damage to electric plug and cord, pull by plug rather than cord when disconnecting the Adapter.**
8. **Do not operate with damaged cord or plug.** *Replace the cord or plug immediately.*

Personal Safety

1.  **Wear ANSI-approved splash-resistant safety goggles and heavy-duty rubber work gloves whenever connecting, disconnecting, or working near battery.** *Battery acid can cause permanent blindness. Avoid touching eyes while working near battery.*
2. **Do not use Power Pack while you are tired or under the influence of drugs, alcohol or medication.** *A moment of inattention while operating Power Pack may result in serious personal injury.*
3. **NEVER smoke or allow a spark or flame in vicinity of battery or engine.**
4. **If battery acid contacts skin or clothing, wash immediately with soap and water. If acid enters eye, immediately flood eye with running cold water for at least 10 minutes and get medical attention immediately.**
5. **Remove personal metal items such as rings, bracelets, necklaces, and watches when working with a lead-acid battery.** *A lead-acid battery can produce a short-circuit current high enough to weld a ring or the like to metal, causing a severe burn.*

6. People with pacemakers should consult their physician(s) before use. Electromagnetic fields in close proximity to heart pacemaker could cause pacemaker interference or pacemaker failure.

Service

Have your Power Pack serviced by a qualified repair person using only identical replacement parts.
This will ensure that the safety of the Power Pack is maintained.

Power Pack Safety Warnings

1. **Lead-acid batteries generate hydrogen gas when charging.** Hydrogen gas is explosive. Only use the Jump-Start system in a well-ventilated area.
2. **Jump Starting A Vehicle**
 - a. Use the Power Pack for jump starting a LEAD-ACID battery only.
 - b. For emergency use only. Do not use the Power Pack as a replacement for a vehicle battery.
 - c. Be sure area around battery is well ventilated while battery is being jump started.
 - d. NEVER jump start a frozen battery.
 - e. Do not attempt to jump start a vehicle with a non-rechargeable or defective battery.
 - f. Study all battery manufacturer's specific precautions for jump starting.
 - g. **DO NOT TOUCH POSITIVE AND NEGATIVE BATTERY CLAMPS TOGETHER.**
 - h. Unplug the Power Pack from its Adapter before connecting its cables to a battery.
- i. Connect and disconnect battery cable clamps only after setting any Jump Starter switches to OFF position.
- j. Connect cables to proper polarities. Connect black cable to negative body ground and red cable to positive battery terminal.
- k. Locate Power Pack as far away from battery as battery cables permit.
3. Maintain labels and nameplates on the Power Pack. These carry important safety information. If unreadable or missing, contact Harbor Freight Tools for a replacement.
4. The warnings, precautions, and instructions discussed in this instruction manual cannot cover all possible conditions and situations that may occur. It must be understood by the operator that common sense and caution are factors which cannot be built into this product, but must be supplied by the operator.



SAVE THESE INSTRUCTIONS.

Specifications

Input	120 VAC, 60Hz, 0.4A
Cranking Amps	330A
Battery	12 VDC, 17Ah
Battery Cables	43" L
Maximum Air Pressure	250 PSI
Functions: 12 Volt Jump-Starter, Air Compressor, 12VDC Power Supply, and 3 LED Work Light	

Setup - Before Use:



Read the **ENTIRE IMPORTANT SAFETY INSTRUCTIONS** section at the beginning of this manual including all text under subheadings therein before setup or use of this product.

Note: For additional information regarding the parts listed in the following pages, refer to *Parts List and Diagram* on page 11.

Functions



Figure A

Charging the Power Pack

WARNING! TO PREVENT SERIOUS INJURY: Always charge on a non-flammable surface.

Press and hold the Battery Test Button on the front of the unit to check the battery power level.

- a. Green light is ready for use.
- b. Yellow light needs to be charged.
- c. Red light should be charged **immediately**.

Turn the Clamp Power Switch on front of unit to the OFF position.

Note: Before initial use, completely charge the Power Pack.

1. Plug the 120VAC Adapter into a 2 or 3-prong outlet.
2. Slide the Adapter socket on the 120VAC Charging Input on the back of the Power Pack.

Approximate AC Charge Time
Initial Charge: 48 hours
Recharge: 30 hours

Figure B

3. The Charging Indicator lights will illuminate in a cycle from red, to yellow, to green while the unit is charging. **The green Charging Indicator light will remain on after charging is complete.** The battery power level must be checked periodically when charging, and the Power Pack must be unplugged when it is fully charged.

NOTE: FAILURE TO RECHARGE POWER PACK WILL VOID WARRANTY.

4. Recharge:
 - a. When yellow light comes on while pressing the Battery Test Button.
 - b. After each Jump-Start.
 - c. Once a month.

DC Appliance Compatibility

The Power Pack can run/charge 12VDC auto, RV, marine, or other portable appliances that draw 10 amps or less.

The lower the amount of watts the appliance draws, the longer the Power Pack can power it before needing to be recharged.

Calculate the total wattage needed to run the appliance before operation. You do not need to calculate startup or surge wattages.

To calculate the size of the load you plan to use with the Power Pack, use the following formula:

$$\text{Amps} \times \text{Volts} = \text{Watts}$$

For example, if you use an appliance whose running amps total 7 amps, you will need 84 watts of power (**7 amps x 12V = 84 Watts**) to run the items. This figure is within the capacity of the unit (**10 amps x 12V = 120 Watts**).

Note: Use this chart as a guideline only.

The actual power usage may vary based on the model or brand of the appliance. Check the actual wattage of your appliances and calculate the amount of power needed to run/charge them.

Appliance	Estimated Power (watts)	Estimated Use (hours)
Fluorescent Light, Cell Phone Charger	4	50
Radio, Fan, Depth Finder	9	26
Video Recorder/Player, Spotlight	15	14
Small Power Tool, Bilge Pump	24	8
Electric Cooler	48	3
Air Compressor	80	2

Figure C

Using the Work Light

1. To turn the Work Light on, press the Work Light button.
2. To turn flashing lights on, press the Work Light button again.
3. To turn the Work Light off, press the Work Light button again.

Jump Starting a Vehicle

Note: Read the vehicle owner's manual pertaining to jump starting prior to using the Power Pack.

1. Press the Battery Test button to verify that the Power Pack is fully charged. Recharge as needed, following the instructions in the “**Charging the Power Pack**” section on page 6.
2. Turn off the vehicle ignition switch and all accessories (lights, radio, climate control, etc.).
3. Turn Clamp Power Switch on the Power Pack to their OFF position. You may leave the Work Light on if needed.

WARNING! TO PREVENT SERIOUS INJURY: DO NOT TOUCH POSITIVE AND NEGATIVE BATTERY CLAMPS TOGETHER.

3. Connect the red Positive Battery Cable to vehicle's positive battery terminal. Connect the black Negative Battery Cable to a non-moving metal part of the vehicle.

Using the Air Compressor

1. Press the Battery Test button to verify that the Power Pack is fully charged. Recharge as needed, following the instructions in the “**Charging the Power Pack**” section on page 6.
2. Open the Air Hose Compartment on the back of the unit and pull out the air hose.
3. Check the proper inflation level for the object that is being inflated.

Tire Inflation

1. Position the Tire Inflator over the valve stem and push down firmly, making sure it is fully seated.
2. Press the lever down. (See Figure D.)

WARNING! TO PREVENT SERIOUS INJURY: DO NOT CONNECT TO THE NEGATIVE TERMINAL OF THE BATTERY.

4. When the correct connection has been made, turn the Clamp Power Switch to the ON position.
5. **WAIT FIVE MINUTES**, then start the vehicle. If the vehicle does not start, wait an additional 3 minutes before trying again.

CAUTION! THE VEHICLE WILL NOT START IF YOU DO NOT WAIT AT LEAST 5 MINUTES.

6. After the vehicle is started, turn the Clamp Power Switch to the OFF position. Remove the black Negative Battery Cable first, and then the red Positive Battery Cable.

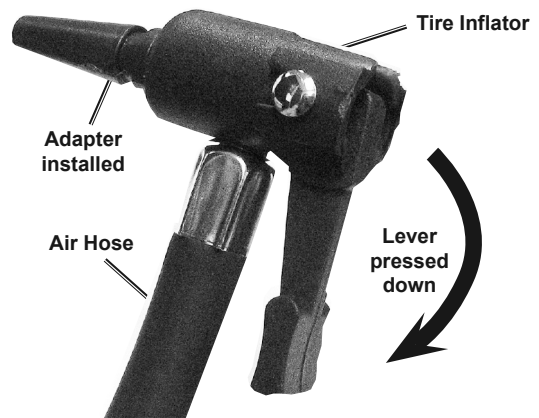

Figure D

3. Press the Air Compressor Switch on.

Note: Monitor the Air Pressure Gauge on the front of the unit to avoid over-inflation.

4. When the proper inflation level has been reached, press the Air Compressor Switch off.
5. Lift the lever and remove the hose.

Using Hose Adapters

1. Three adapters are included with the Power Pack that can be attached to the Tire Inflator. (See Figure E.)

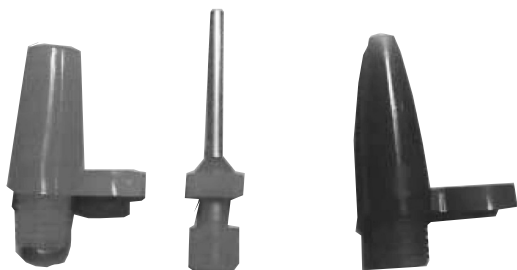

Figure E

2. Attach the proper adapter to the Tire Inflator for the object to be inflated.
3. Insert the adapter into the object's receptacle and press the lever down.
4. Press the Air Compressor Switch on.

Note: Monitor the Air Pressure Gauge on the front of the unit to avoid over-inflation.

5. When the proper inflation level has been reached, press the Air Compressor Switch off.
6. Lift the lever and remove the hose.

WARNING! TO PREVENT SERIOUS INJURY: Do not overinflate any object.

Running DC Appliances

1. Press the Battery Test Button to verify that the Power Pack is fully charged. Recharge as needed, following the instructions in the “**Charging the Power Pack**” section on page 6.
2. Make sure the total wattage of the appliance is within the range of the Power Pack. See “**DC Appliance Compatibility**” on page 7.
3. Make sure that the Clamp Power Switch and appliance are off.
4. Plug the appliance into the 12VDC Outlet.
5. Turn on the appliance.
6. When finished using, turn off and unplug the appliance.

Running/Charging USB Devices

1. Press the Battery Test button to verify that the Power Pack is fully charged. Recharge as needed, following the instructions in the “**Charging the Power Pack**” section on page 6.
2. Plug the device into the USB Port.
3. When finished, unplug the device from the USB Port.

Record Product's Serial Number Here: _____

Note: If product has no serial number, record month and year of purchase instead.

Note: Some parts are listed and shown for illustration purposes only, and are not available individually as replacement parts. Internal parts are not user-serviceable and are not available. Specify UPC 193175419385 when ordering parts.

Maintenance and Servicing



Procedures not specifically explained in this manual must be performed only by a qualified technician.

WARNING

TO PREVENT SERIOUS INJURY: Unplug the Power Pack, turn the Clamp Power Switch off and allow Power Pack to cool completely before performing any inspection, maintenance, or cleaning procedures.

- BEFORE EACH USE**, inspect the general condition of the Power Pack. Check for:
 - loose hardware,
 - cracked or broken parts,
 - damaged electrical wiring or cable insulation, and
 - any other condition that may affect its safe operation.
- Keep unit clean and clamps free of dirt, debris, or grease.
- For longer working life, protect Power Pack from sunlight and moisture.
- AFTER USE**, wipe external surfaces of the Power Pack with clean cloth.
- CONTAINS NON-SPILLABLE, SEALED LEAD-ACID BATTERY. BATTERY MUST BE RECYCLED.**

Battery Replacement and Disposal

LEAD BATTERY MUST BE RECYCLED.

WARNING! To prevent damage or serious injury, replacement battery must be identical to original.

Replace the Battery when the red light comes on while pressing the Battery Test button after recharging.

- Remove all screws from the back of the case and lift off the panel.
- Lift out the Battery without damaging the circuit board.

Note: Notice how the red and black cables connect to the old battery and make sure to keep them in place, connecting them to the new battery.

- Detach the recharging wires and Battery Cables from the battery terminals.
- Position the replacement battery with the label facing out, and make sure the **red (+)** recharging wire and Battery Cable is attached to the **positive (+)** battery terminal. Connect both of the recharging wires and Battery Cables.
- Carefully slide the Battery into the compartment without damaging the circuit board.
- Replace the back panel and the screws.

PLEASE READ THE FOLLOWING CAREFULLY

THE MANUFACTURER AND/OR DISTRIBUTOR HAS PROVIDED THE PARTS LIST AND ASSEMBLY DIAGRAM IN THIS MANUAL AS A REFERENCE TOOL ONLY. NEITHER THE MANUFACTURER OR DISTRIBUTOR MAKES ANY REPRESENTATION OR WARRANTY OF ANY KIND TO THE BUYER THAT HE OR SHE IS QUALIFIED TO MAKE ANY REPAIRS TO THE PRODUCT, OR THAT HE OR SHE IS QUALIFIED TO REPLACE ANY PARTS OF THE PRODUCT. IN FACT, THE MANUFACTURER AND/OR DISTRIBUTOR EXPRESSLY STATES THAT ALL REPAIRS AND PARTS REPLACEMENTS SHOULD BE UNDERTAKEN BY CERTIFIED AND LICENSED TECHNICIANS, AND NOT BY THE BUYER. THE BUYER ASSUMES ALL RISK AND LIABILITY ARISING OUT OF HIS OR HER REPAIRS TO THE ORIGINAL PRODUCT OR REPLACEMENT PARTS THERETO, OR ARISING OUT OF HIS OR HER INSTALLATION OF REPLACEMENT PARTS THERETO.

Parts List and Diagram

Part	Description	Qty
1	Air Hose Compartment Cover	1
2	Clear Cover	1
3	Pressure Gauge Holder	1
4	Back Housing	1
5	Adapter	1
6	Transformer Holder	1
7	Handle	1
8	Inflator	1
9	Battery	1
10	PCB Board	1

Part	Description	Qty
11	Front Housing	1
12	Left Soft Cover	1
13	Work Light LED Set	1
14	Front Panel	1
15	Right Soft Cover	1
16	Clamp Power Switch	1
17	Bottom Soft Cover	3
18	Air Hose with Tire Inflator (not shown)	1
19	Hose Adapter Set (not shown)	1

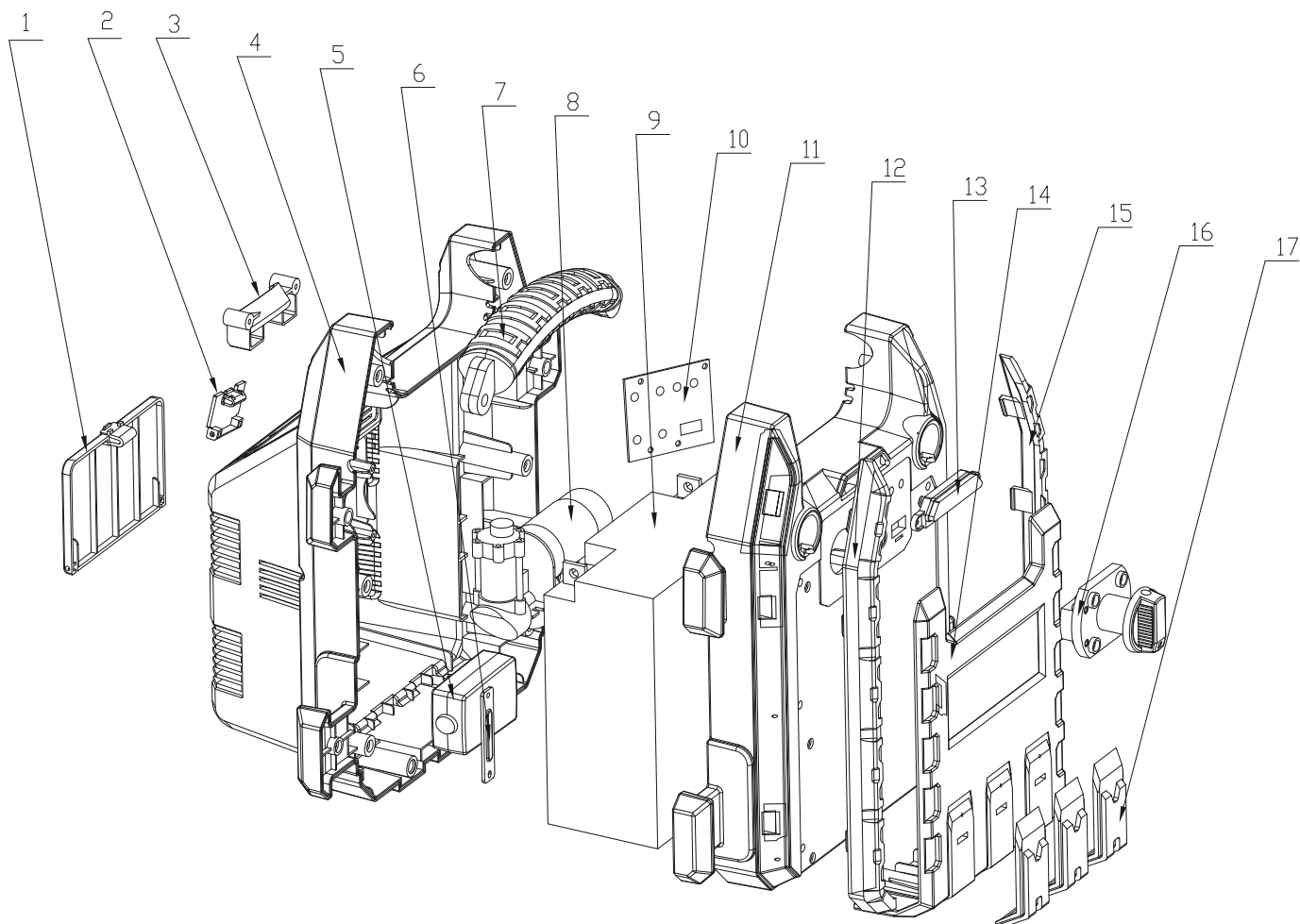

SAFETY

SETUP

OPERATION

MAINTENANCE

Limited 90 Day Warranty

Harbor Freight Tools Co. makes every effort to assure that its products meet high quality and durability standards, and warrants to the original purchaser that this product is free from defects in materials and workmanship for the period of 90 days from the date of purchase. This warranty does not apply to damage due directly or indirectly, to misuse, abuse, negligence or accidents, repairs or alterations outside our facilities, criminal activity, improper installation, normal wear and tear, or to lack of maintenance. We shall in no event be liable for death, injuries to persons or property, or for incidental, contingent, special or consequential damages arising from the use of our product. Some states do not allow the exclusion or limitation of incidental or consequential damages, so the above limitation of exclusion may not apply to you. THIS WARRANTY IS EXPRESSLY IN LIEU OF ALL OTHER WARRANTIES, EXPRESS OR IMPLIED, INCLUDING THE WARRANTIES OF MERCHANTABILITY AND FITNESS.

To take advantage of this warranty, the product or part must be returned to us with transportation charges prepaid. Proof of purchase date and an explanation of the complaint must accompany the merchandise. If our inspection verifies the defect, we will either repair or replace the product at our election or we may elect to refund the purchase price if we cannot readily and quickly provide you with a replacement. We will return repaired products at our expense, but if we determine there is no defect, or that the defect resulted from causes not within the scope of our warranty, then you must bear the cost of returning the product.

This warranty gives you specific legal rights and you may also have other rights which vary from state to state.

CEN-TECH®

26541 Agoura Road • Calabasas, CA 91302 • 1-888-866-5797