

Owner's Manual & Safety Instructions

Save This Manual Keep this manual for the safety warnings and precautions, assembly, operating, inspection, maintenance and cleaning procedures. Write the product's serial number in the back of the manual near the assembly diagram (or month and year of purchase if product has no number). Keep this manual and the receipt in a safe and dry place for future reference.

191

EARTHQUAKE XT EQC XT-12V

56663

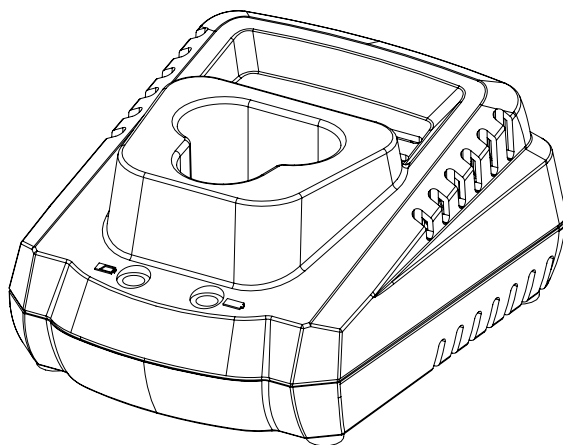

12V MAX LITHIUM

BATTERY CHARGER

Visit our website at: <http://www.harborfreight.com>
Email our technical support at: productsupport@harborfreight.com



When unpacking, make sure that the product is intact and undamaged. If any parts are missing or broken, please call 1-888-866-5797 as soon as possible.





Copyright © 2019 by Harbor Freight Tools®. All rights reserved.

No portion of this manual or any artwork contained herein may be reproduced in any shape or form without the express written consent of Harbor Freight Tools. Diagrams within this manual may not be drawn proportionally. Due to continuing improvements, actual product may differ slightly from the product described herein. Tools required for assembly and service may not be included.

⚠ WARNING

Read this material before using this product. Failure to do so can result in serious injury. **SAVE THIS MANUAL.**

WARNING SYMBOLS AND DEFINITIONS

	This is the safety alert symbol. It is used to alert you to potential personal injury hazards. Obey all safety messages that follow this symbol to avoid possible injury or death.
	Indicates a hazardous situation which, if not avoided, will result in death or serious injury.
	Indicates a hazardous situation which, if not avoided, could result in death or serious injury.
	Indicates a hazardous situation which, if not avoided, could result in minor or moderate injury.
	Addresses practices not related to personal injury.

IMPORTANT SAFETY INFORMATION

Charger Safety Warnings

⚠️WARNING

Read all safety warnings and all instructions.

Failure to follow the warnings and instructions may result in electric shock, fire and/or serious injury.

Save all warnings and instructions for future reference.

The warnings, precautions, and instructions discussed in this instruction manual cannot cover all possible conditions and situations that may occur. It must be understood by the operator that common sense and caution are factors which cannot be built into this product, but must be supplied by the operator.

1.  The battery Charger gets hot during use. The Charger's heat can build up to unsafe levels and create a fire hazard if it does not receive adequate ventilation, due to an electrical fault, or if it is used in a hot environment. Do not place the Charger on a flammable surface. Do not obstruct any vents on the Charger. **Especially avoid placing the Charger on carpets and rugs; they are not only flammable, but they also obstruct vents under the Charger.** Place the Charger on a stable, solid, nonflammable surface (such as a stable metal workbench or concrete floor) at least 1 foot away from all flammable objects, such as drapes or walls. Keep a fire extinguisher and a smoke detector in the area. Frequently monitor the Charger and Battery Pack while charging.
2. **Charge only designated Battery Packs; others may overheat, leak, or burst.**
3. **Follow charging instructions.**
4. **Do not insert damaged Battery Pack.**
5. **Check frequently while charging.**
6. **Wear ANSI-approved safety goggles during use.**
7. **Use chargers only with specifically designated Battery Packs. Use of any other Battery Packs may create a risk of injury and fire.**
8. **When Battery Pack is not in use, keep it away from other metal objects, like paper clips, coins, keys, nails, screws or other small metal objects, that can make a connection from one terminal to another. Shorting the Battery Pack terminals together may cause burns or a fire.**
9. **Under abusive conditions, liquid may be ejected from the Battery Pack; avoid contact. If contact accidentally occurs, flush with water. If liquid contacts eyes, additionally seek medical help. Liquid ejected from the battery pack may cause irritation or burns.**
10. Do not expose chargers to rain or wet conditions. Water entering a Charger will increase the risk of electric shock. Charge indoors only.
11. Keep charging area clean and well lit. Cluttered or dark areas invite accidents.
12. Do not operate chargers in explosive atmospheres, such as in the presence of flammable liquids, gases or dust. Chargers create sparks which may ignite the dust or fumes.
13. Charger plugs must match the outlet. Never modify the plug in any way. Unmodified plugs and matching outlets will reduce risk of electric shock.
14. Do not abuse the cord. Never use the cord for carrying, pulling or unplugging the Charger. Keep cord away from heat, oil, sharp edges or moving parts. Damaged or entangled cords increase the risk of electric shock.

15. Store idle chargers out of the reach of children and do not allow persons unfamiliar with the Charger or these instructions to operate the Charger.
16. Maintain chargers. Check for breakage of parts and any other condition that may affect the Charger's operation. If damaged, have the Charger repaired before use.
17. Have your Charger serviced by a qualified repair person using only identical replacement parts. This will ensure that the safety of the Charger is maintained.
18. Inspect before every use; do not use if parts are loose or damaged.
19. Use as intended only.
20. Unplug after use and before service, cleaning or storage.
21. Maintain labels and nameplates on the Charger. These carry important safety information. If unreadable or missing, contact Harbor Freight Tools for a replacement.
22. This product is not a toy. Keep it out of reach of children.
23. People with pacemakers should consult their physician(s) before use. Electromagnetic fields in close proximity to heart pacemaker could cause pacemaker interference or pacemaker failure. In addition, people with pacemakers should properly maintain and inspect to avoid electrical shock.

Lithium Battery Safety Warnings



LITHIUM BATTERIES STORE A LARGE AMOUNT OF ENERGY AND WILL VENT FIRE OR EXPLODE IF MISTREATED:



1. **DO NOT DO ANY OF THE FOLLOWING TO THE BATTERY PACK:**
 - a. **Open,**
 - b. **Drop,**
 - c. **Short-circuit,**
 - d. **Puncture,**
 - e. **Incinerate, or**
 - f. **Expose to temperatures greater than 140°F.**
2. **Keep Battery Pack dry.**
3. Charge Battery Pack only according to its Charger's instructions.
4. Inspect Battery Pack before every use; do not use or charge if damaged.



SAVE THESE INSTRUCTIONS.

Grounding

⚠WARNING









TO PREVENT ELECTRIC SHOCK AND DEATH FROM INCORRECT GROUNDING:

Check with a qualified electrician if you are in doubt as to whether the outlet is properly grounded. Do not modify the power cord plug provided with the charger. Do not use the charger if the power cord or plug is damaged. If damaged, have it repaired by a service facility before use. If the plug will not fit the outlet, have a proper outlet installed by a qualified electrician.

Extension Cords

Note: Extension cords must not be used with this Charger.

Symbology

	Double Insulated		Read the manual before set-up and/or use.
V	Volts		WARNING marking concerning Risk of Fire. Do not cover Charger ventilation ducts. Charge on fireproof surface only.
~	Alternating Current		WARNING marking concerning Risk of Electric Shock. Properly connect Charger's power cord to appropriate outlet.
A	Amperes		WARNING marking concerning Risk of Explosion. Do not puncture, short, or open Battery Packs and do not charge damaged Battery Packs.
	WARNING marking concerning Risk of Eye Injury. Wear ANSI-approved safety goggles with side shields.		

Specifications

Input Rating	120VAC, 60Hz, 30W
Output	12.6VDC / 1.5A
Battery Type	Earthquake Li-Ion

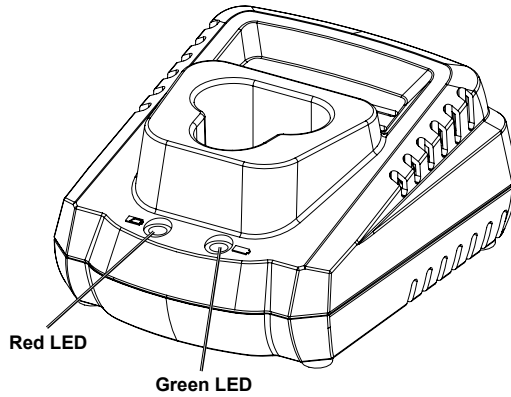

Figure A: Indicators

EARTHQUAKE^{XT}

Operating Instructions



Read the **ENTIRE IMPORTANT SAFETY INFORMATION** section at the beginning of this manual including all text under subheadings therein before set up or use of this product.

1. Place the Battery Pack on a dry fireproof surface in a room where the temperature is from 50–104° F.
5. Slide the Battery Pack onto the Charger. The Red LED will remain on while the Battery Pack is charging.

Note: If recharging a newly spent Battery Pack, allow it to cool completely before charging.

2. Examine the Battery Pack.
It must be undamaged and a 12V, lithium-ion type Battery Pack. **Do not charge a cracked, open, or leaking Battery Pack, or charge a non-recommended type of Battery Pack.**
3. The Battery Pack's terminals are designed to fit this Charger specifically. If the Battery Pack does not fit the Charger properly, do not try to insert it. **Do not force a Battery Pack into the Charger.**
4. Plug the Charger directly into a grounded, 120VAC, 60Hz receptacle. When the Charger is ready to charge a Battery Pack, the Green LED will remain on.
6. While charging, the Battery Pack and Charger may become warm to the touch. This is normal, and does not indicate a problem.
7. The Green LED will light and remain lit when the Battery Pack is charged.
8. Allow the Battery Pack to cool completely before using it.
9. Unplug the Charger when not in use.

Note: If the Red LED blinks instead, the Battery Pack could not be charging properly. Check that connections are clean and tight, and that Battery Pack and Charger are both at proper charging temperature. If that does not allow the Battery Pack to charge properly, it may be worn out or internally damaged. Do not leave a worn out or internally damaged Battery Pack in the Charger.

EARTHQUAKE XT

Maintenance and Servicing



Procedures not specifically explained in this manual must be performed only by a qualified technician.

⚠WARNING

TO PREVENT SERIOUS INJURY FROM ACCIDENTAL OPERATION:
Remove the Battery Pack and unplug the charger before performing any inspection, maintenance, or cleaning procedures.

TO PREVENT SERIOUS INJURY FROM TOOL FAILURE:
Do not use damaged equipment.
If damage is noted, have the problem corrected before further use.

1. **BEFORE EACH USE**, inspect the general condition of the charger. Check for:
 - loose hardware,
 - misalignment or binding of moving parts,
 - cracked or broken parts,
 - damaged electrical wiring, and
 - any other condition that may affect its safe operation.
2. **AFTER USE**, wipe external surfaces of the charger with clean cloth.
3. Disconnect Battery Pack and store Charger and any Battery Packs in a dry, indoor area out of reach of children and away from metal objects (i.e., paperclips, coins) to prevent shorting.

WARNING! TO PREVENT SERIOUS INJURY AND DEATH FROM ELECTRIC SHOCK:
Do not open Charger.
Do not service internal parts.

Record Product's Serial Number Here: _____

Note: If product has no serial number, record month and year of purchase instead.

Note: Replacement parts are not available for this item.

Note: This equipment has been tested and found to comply with the limits for a Class B digital device, pursuant to part 15 of the FCC Rules. These limits are designed to provide reasonable protection against harmful interference in a residential installation. This equipment generates, uses and can radiate radio frequency energy and, if not installed and used in accordance with the instructions, may cause harmful interference to radio communications. However, there is no guarantee that interference will not occur in a particular installation. If this equipment does cause harmful interference to radio or television reception, which can be determined by turning the equipment off and on, the user is encouraged to try to correct the interference by one or more of the following measures:

- Reorient or relocate the receiving antenna.
- Increase the separation between the equipment and receiver.
- Connect the equipment into an outlet on a circuit different from that to which the receiver is connected.
- Consult the dealer or an experienced radio/TV technician for help.

Limited 90 Day Warranty

Harbor Freight Tools Co. makes every effort to assure that its products meet high quality and durability standards, and warrants to the original purchaser that this product is free from defects in materials and workmanship for the period of 90 days from the date of purchase. This warranty does not apply to damage due directly or indirectly, to misuse, abuse, negligence or accidents, repairs or alterations outside our facilities, criminal activity, improper installation, normal wear and tear, or to lack of maintenance. We shall in no event be liable for death, injuries to persons or property, or for incidental, contingent, special or consequential damages arising from the use of our product. Some states do not allow the exclusion or limitation of incidental or consequential damages, so the above limitation of exclusion may not apply to you. THIS WARRANTY IS EXPRESSLY IN LIEU OF ALL OTHER WARRANTIES, EXPRESS OR IMPLIED, INCLUDING THE WARRANTIES OF MERCHANTABILITY AND FITNESS.

To take advantage of this warranty, the product or part must be returned to us with transportation charges prepaid. Proof of purchase date and an explanation of the complaint must accompany the merchandise. If our inspection verifies the defect, we will either repair or replace the product at our election or we may elect to refund the purchase price if we cannot readily and quickly provide you with a replacement. We will return repaired products at our expense, but if we determine there is no defect, or that the defect resulted from causes not within the scope of our warranty, then you must bear the cost of returning the product.

This warranty gives you specific legal rights and you may also have other rights which vary from state to state.

