

Owner's Manual & Safety Instructions

Save This Manual Keep this manual for the safety warnings and precautions, assembly, operating, inspection, maintenance and cleaning procedures. Write the product's serial number in the back of the manual near the assembly diagram (or month and year of purchase if product has no number). Keep this manual and the receipt in a safe and dry place for future reference.

20d



PROPANE TORCH

FOR YOUR SAFETY IF YOU SMELL GAS:

1. Open windows (if indoors).
2. Don't touch electrical switches.
3. Extinguish any open flame.
4. Immediately call your gas supplier.

FOR YOUR SAFETY

Do not store or use gasoline or other flammable vapors and liquids in the vicinity of this or any other propane-burning device.

WARNING: Improper installation, adjustment, alteration, service, or maintenance can cause injury or property damage. Refer to this manual. For assistance or additional information consult a qualified service technician, service agency, manufacturer, or the gas supplier.



57061
Manual Start



57062
Trigger Start

Visit our website at: <http://www.harborfreight.com>
Email our technical support at: productsupport@harborfreight.com

When unpacking, make sure that the product is intact and undamaged. If any parts are missing or broken, please call 1-888-866-5797 as soon as possible.

Copyright© 2020 by Harbor Freight Tools®. All rights reserved.
No portion of this manual or any artwork contained herein may be reproduced in any shape or form without the express written consent of Harbor Freight Tools. Diagrams within this manual may not be drawn proportionally. Due to continuing improvements, actual product may differ slightly from the product described herein.
Tools required for assembly and service may not be included.

⚠WARNING

Read this material before using this product.
Failure to do so can result in serious injury.
SAVE THIS MANUAL.

Important Propane Safety Information for You and Your Family



IF YOU SMELL GAS

- 1. NO FLAMES OR SPARKS!**
Immediately put out all smoking materials and other open flames. Do not operate lights, appliances, telephones, or cell phones. Flames or sparks from these sources can trigger an explosion or a fire.
- 2. LEAVE THE AREA IMMEDIATELY!**
Get everyone out of the building or area where you suspect gas is leaking.
- 3. SHUT OFF THE GAS.**
Turn off the main gas supply valve on your propane tank if it is safe to do so. To close the valve, turn it to the right (clockwise).
- 4. REPORT THE LEAK.** From a neighbor's home or other nearby building away from the gas leak, call your propane retailer right away. If you can't reach your propane retailer, call 911 or your local fire department.
- 5. DO NOT RETURN TO THE BUILDING OR AREA** until your propane retailer, emergency responder, or qualified service technician determines that it is safe to do so.
- 6. GET YOUR SYSTEM CHECKED.** Before you attempt to use any of your propane appliances, your propane retailer or a qualified service technician must check your entire system to ensure that it is leak-free.

CAN YOU SMELL IT?

Propane smells like rotten eggs, a skunk's spray, or a dead animal. Some people may have difficulty smelling propane due to their age (older people may have a less sensitive sense of smell); a medical condition; or the effects of medication, alcohol, tobacco, or drugs.

ODOR LOSS. On rare occasions, propane can lose its odor. Several things can cause this including:

- The presence of air, water, or rust in a propane tank or cylinder
- The passage of leaking propane through the soil



Since there is a possibility of odor loss or problems with your sense of smell, you should respond immediately to even a faint odor of gas.

PROPANE GAS DETECTORS

Under some circumstances, you may not smell a propane leak. Propane gas detectors sound an alarm if they sense propane in the air. They can provide an additional measure of security. You should consider the purchase of one or more detectors for your home.

GUIDELINES regarding propane gas detectors:

- Buy only units that are listed by Underwriters Laboratories (UL).
- Follow the manufacturer's instructions regarding installation and maintenance.
- Never ignore the smell of propane, even if no detector is sounding an alarm.

APPLIANCE MAINTENANCE

LEAVE IT TO THE EXPERTS.

Only a qualified service technician has the training to install, inspect, service, maintain, and repair your appliances. Have your appliances and propane system inspected just before the start of each heating season.

DO NOT TRY TO MODIFY OR REPAIR valves, regulators, connectors, controls, or other appliance and cylinder/tank parts. Doing so creates the risk of a gas leak that can result in property damage, serious injury, or death.

CO AND YOUR SAFETY

WHAT IS CARBON MONOXIDE (CO)?

You can't taste or smell CO, but it is a very dangerous gas. High levels of CO can come from appliances that are not operating correctly, or from a venting system or chimney that becomes blocked.

CO CAN BE DEADLY! High levels of CO can make you dizzy or sick. In extreme cases, CO can cause brain damage or death. Symptoms of CO poisoning include: headache, dizziness, fatigue, shortness of breath, and nausea.



IF YOU SUSPECT CO IS PRESENT, ACT IMMEDIATELY!

1. If you or a family member shows physical symptoms of CO poisoning, get everyone out of the building and call 911 or your local fire department.
2. If it is safe to do so, open windows to allow entry of fresh air, and turn off any appliances you suspect may be releasing CO.
3. If no one has symptoms, but you suspect that CO is present, call your propane retailer or a qualified service technician to check CO levels and your propane equipment.

CO DETECTORS CAN IMPROVE SAFETY.

For an extra measure of safety, consider installing a CO detector listed by UL on each level of your home.

TO HELP REDUCE THE RISK OF CO POISONING:

- Have a qualified service technician check your propane appliances and venting systems annually, preferably before the heating season.
- Install UL-listed CO detectors on every level of your home.
- Never use a gas oven or range-top burners to provide space heating.
- Never use portable heaters indoors unless they are designed and approved for indoor use.
- Never use a barbecue grill (propane or charcoal) indoors for cooking or heating.
- Regularly check your appliance exhaust vents for blockage.

RUNNING OUT OF GAS







DON'T RUN OUT OF GAS. SERIOUS SAFETY HAZARDS, INCLUDING FIRE OR EXPLOSION, CAN RESULT.

- If an appliance valve or a gas line is left open, a leak could occur when the system is recharged with propane.
- If your propane tank runs out of gas, any pilot lights on your appliances will go out. This can be extremely dangerous.
- **A LEAK CHECK IS REQUIRED.** In many states, a propane retailer or a qualified service technician must perform a leak check of your propane system before turning on the gas.



LIGHTING PILOT LIGHTS



IF A PILOT LIGHT REPEATEDLY GOES OUT or is very difficult to light, there may be a safety problem. **DO NOT** try to fix the problem yourself. It is strongly recommended that only a **QUALIFIED SERVICE TECHNICIAN** light any pilot light that has gone out.

YOU ARE TAKING THE RISK of starting a fire or an explosion if you light a pilot light yourself. Carefully follow all of the manufacturer's instructions and warnings concerning the appliance before attempting to light the pilot.

WARNING SYMBOLS AND DEFINITIONS	
	This is the safety alert symbol. It is used to alert you to potential personal injury hazards. Obey all safety messages that follow this symbol to avoid possible injury or death.
 DANGER	Indicates a hazardous situation which, if not avoided, will result in death or serious injury.
 WARNING	Indicates a hazardous situation which, if not avoided, could result in death or serious injury.
 CAUTION	Indicates a hazardous situation which, if not avoided, could result in minor or moderate injury.
NOTICE CAUTION	Addresses practices not related to personal injury.

Symbol Definitions

Symbol	Property or Statement
	Warning marking concerning Risk of Burns. Wear flame retardant gloves during use.
	WARNING marking concerning Risk of Eye Injury. Wear ANSI-approved safety goggles with side shields.
	Read the manual before set-up and/or use.

Symbol	Property or Statement
	WARNING marking concerning Risk of Respiratory Injury. Operate torch OUTSIDE and far away from windows, doors, and vents.
	WARNING marking concerning Risk of Fire while handling propane. Do not smoke while handling gas.

IMPORTANT SAFETY INFORMATION

WARNING

Improper assembly, installation, adjustment, alteration, service, use, or maintenance can cause property damage, PERSONAL INJURY, or DEATH.

Read all safety warnings and all instructions.

Failure to follow the warnings and instructions may result in electric shock, fire and/or serious injury.

The warnings, precautions, and instructions discussed in this instruction manual cannot cover all possible conditions and situations that may occur. It must be understood by the operator that common sense and caution are factors which cannot be built into this product, but must be supplied by the operator.

Save all warnings and instructions for future reference.

Leaking Propane Gas

- If you smell gas:
 - Shut off gas to the torch.
 - Extinguish any open flame.
 - Do not light a match or operate an electrical switch.
 - Evacuate the area at once.
 - Call for professional help.
- Propane gas is a gas you cannot see or smell. Propane gas normally has an odorant added to aid detection. The odorant smells like "rotten eggs". The odorant may fade over time, so leaking gas may not be detectable by smell alone.
- Propane gas is heavier than air and will collect in low areas.

Risk of Fire and/or Explosion



1. Do not store extra propane tanks in the torch work area.
2. If gas is smelled during operation, immediately close the valve on the propane tank. Propane gas is odorless. An odor-making agent is added to propane/LP gas to enable you to smell the gas if it may be leaking.
3. If the torch shuts off during operation, close the valve on the propane tank. Check the amount of gas in the tank and wait 5 minutes for the gas to clear before restarting. If it continues to shut off during operation, have it serviced by a qualified technician.
4. Do not use the torch within 15 feet of flammable objects such as wood, trees, overhangs, and umbrellas.
5. Do not store propane near high heat, open flames, pilot lights, direct sunlight, other ignition sources or where temperatures exceed 120°F.
6. Do not use in spaces which may contain volatile or airborne combustibles, or products such as gasoline, solvents, paint thinner, dust particles or unknown chemicals.
7. Operate with the propane tank in its vertical upright position. While in operation, do not tilt or lean the propane tank on its side. Do not turn the tank upside down, not even when it seems empty, as this may cause clogging of valves and components which could lead to dangerous flare-ups or fire.
8. Do not install or remove the Propane tank while the torch is lighted, near flames, pilot lights or other ignition sources or while the torch is hot. Only do this in an outdoor, well-ventilated area.
9. Remove all packing materials before using this product.
10. Do not use below ground level.
11. Read instructions provided with propane tank before connection or use.

Carbon Monoxide Hazard



Burning propane indoors CAN KILL YOU IN MINUTES.

Exhaust from propane-fueled equipment contains carbon monoxide. This is a poison you cannot see or smell.

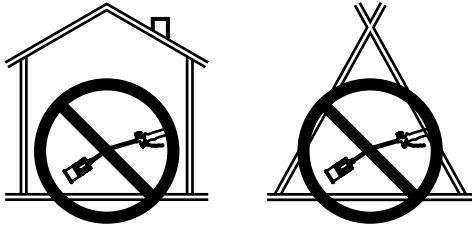

NEVER use inside a home, tent, camper, or garage, EVEN IF doors and windows are open.

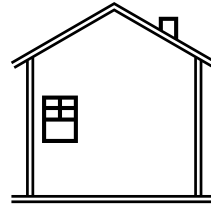

Only use OUTSIDE and far away from windows, doors, and vents.

Early signs of carbon monoxide poisoning resemble the flu, with headaches, dizziness, or nausea. If you have these signs, this item may not be working properly. Get fresh air **immediately**.

DO NOT USE THIS ITEM FOR SPACE HEATING.

Risk of Burns – Product Gets Very Hot During Use



1. **Do not touch the burner while the torch is lit.**
Before servicing, wait 30 minutes for it to cool down.
2. **Keep children away from the work area.**

Operation Precautions

1. Inspect before each use; do not use if parts loose, leaking, or damaged.
Connect, then check for leaks using soapy water. Do not use flame to check for leaks.
Only qualified technician may repair product.
2. Close torch gas control knob before connection.
3. Close torch gas control knob after use and before leaving area. Do not leave unattended while lit.
4. Set up and use according to manual instructions only.
5. Wear ANSI-approved safety goggles with side shields and flame retardant gloves during use.
6. This torch must be used only with HD-5 propane gas. The propane tank should hold no more than 20 pounds of LP gas. Do not use bulk tanks of larger capacity. Do not use any other fuel.
The torch must be used only with a vapor withdrawal LP propane tank equipped with a POL valve. The tank must be constructed and marked in such a way as to comply with the specifications for LP gas tanks by the U.S. Department of Transportation (DOT).
7. The use of this product must be in conformity with local codes or, in the absence of local codes, with the standard for storage and Handling of Liquefied Petroleum Gases, ANSI/NFPA 58. For Canada, the use must be in accordance with the current CAN/CGA B149.2 installation codes.
8. Keep children away. Children must never be allowed in the work area. Do not let them handle, move, or adjust this product.
9. Store idle equipment. When not in use, this product must be stored in a dry location to inhibit rust. Lock up torches and keep out of reach of children.
10. Use as intended only. Do not alter product in any way, or use with any accessory not specifically designed for this product.
11. Maintain product labels and nameplates. These carry important safety information. If unreadable or missing, contact Harbor Freight Tools for a replacement.

IMPORTANT SAFEGUARDS

1. **READ ALL INSTRUCTIONS**
2. Before using, check all parts for proper function and damage to component parts.
3. Do not use this torch to heat, mold or bend plastic sheets, moulding or tubing.
4. Hidden areas such as behind walls, ceilings, floors, soffit boards and other panels may contain flammable materials that could be ignited by the torch when working in these locations. The ignition of these materials may not be readily apparent and could result in property damage and injury to persons. When working in these locations, keep the torch moving in a back-and-forth motion. Lingering or pausing in one spot could ignite the panel or the material behind it.
5. Do not use this torch to remove paint.



SAVE THESE INSTRUCTIONS.

Specifications

Product Compatibility	Standard 20 lb Barbecue Propane Tank
Maximum Flame Temperature	2,000° F

Setup: Before Use



Read the **ENTIRE IMPORTANT SAFETY INFORMATION** section at the beginning of this manual including all text under subheadings therein before set up or use of this product.

Note: For additional information regarding the parts listed in the following pages, refer to the Assembly Diagram near the end of this manual.

Functions

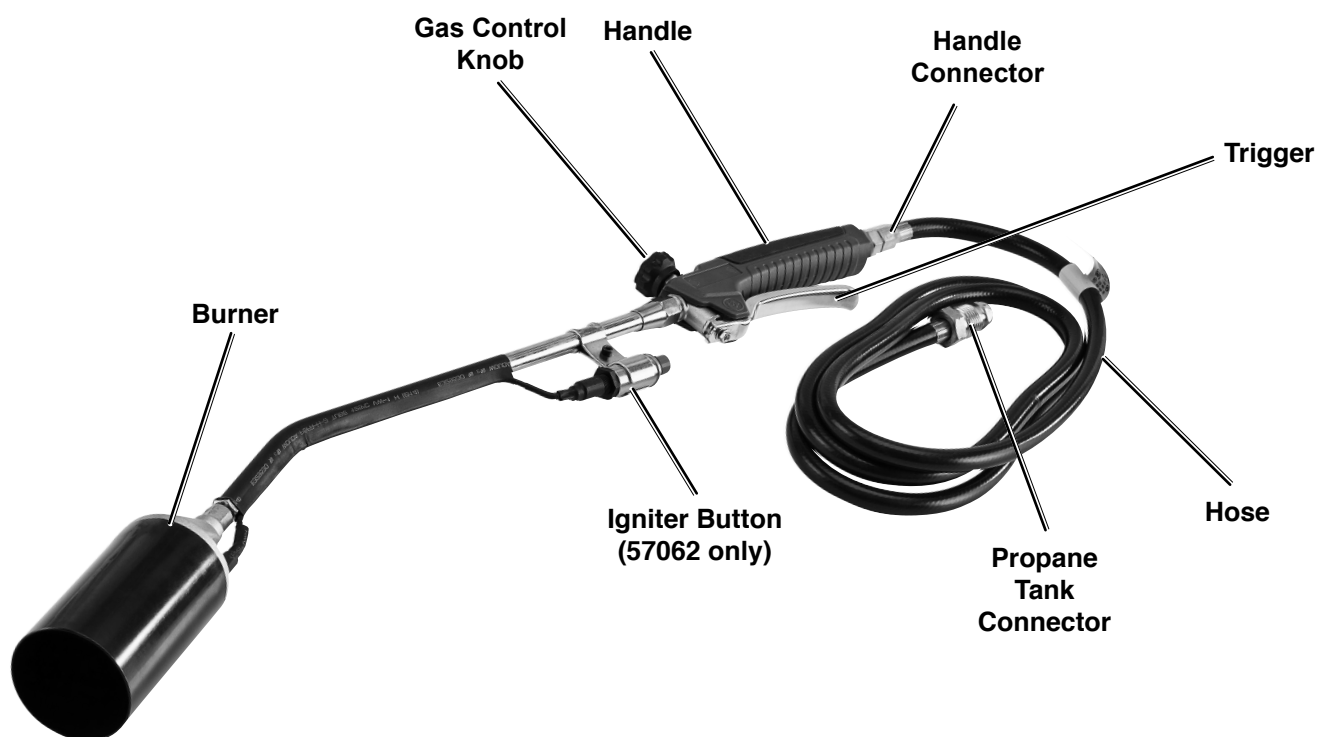

Operation Instructions



Read the **ENTIRE IMPORTANT SAFETY INFORMATION** section at the beginning of this document including all text under subheadings therein before set up or use of this product.

WARNING

TO PREVENT SERIOUS INJURY AND DEATH FROM FIRE:

Have multiple ABC class fire extinguishers nearby.

Be familiar with fire extinguishing techniques before use of this item.

WARNING! TO PREVENT SERIOUS INJURY:
Wear ANSI-approved safety goggles with side shields and flame retardant gloves during use.

WARNING! TO PREVENT SERIOUS INJURY:
Do not use thread seal tape, it will weaken the seal at the connections and can cause leaks.

1. Turn the Gas Control Knob and the gas valve on the propane tank off.
2. Connect the Hose to the Handle by threading the Handle Connector onto the Hose Connector. Tighten securely with the Wrench.
3. Connect the Hose to the propane tank by threading the Propane Tank Connector firmly into the propane tank's connector. Tighten securely with included tank wrench.
4. Turn the Gas Control Knob off. Open the gas valve on the propane tank and check and smell for gas leaks. Perform a bubble test:
 - a. Apply warm soapy water over every joint, regulator, fitting, and anywhere else there may be a possible leak.
 - b. Observe carefully to see if bubbles expand, indicating a leak. A large leak can blow the soapy solution away instead of forming bubbles.
 - c. If leaks are found, do not use the Torch until the leaks have been stopped.
 - d. After testing, close the gas valve on the propane tank.
5. Point the Burner in a safe direction, well away from people and combustible materials.
6. Open the gas valve on the propane tank. Turn the Gas Control Knob slightly counterclockwise.
7. **57061 - Manual Start:** With the Propane Torch in a vertical position in a safe direction, insert the lit end of a fireplace/barbecue lighter through one of the slots on the side of the Burner to ignite the flame.
8. **57062 - Trigger Start:** With the Propane Torch in a vertical position in a safe direction, push the Igniter Button. It may be necessary to push the Igniter Button several times to ignite the flame.
9. Adjust the flame to its lowest setting while maintaining a blue flame with an orange halo.
10. To achieve a working flame, depress the Trigger, then apply flame to work surface.
11. Release the Trigger to return to low flame.
12. When finished:
 - a. Close the propane tank's valve.
 - b. Allow remaining propane to flow out of the Burner until the flame extinguishes itself.
 - c. Turn the Gas Control Knob completely clockwise.
 - d. Disconnect Hose from propane tank.
 - e. Let Torch cool for 30 minutes on a non-flammable surface.
13. Store propane tank in an area where there is free air circulation, at least 10 ft from building openings (such as windows and doors), and at least 20 ft from air intakes of air conditioning and ventilating systems. Tightly install threaded valve plug (not included) into disconnected propane tank.
14. Store the Torch in a clean, dry location out of reach of children.



GREENWOOD™

Inspection, Maintenance, and Cleaning



Procedures not specifically explained in this manual must be performed only by a qualified technician.

Any guard or other protective device removed for servicing must be replaced before operation.

⚠️ WARNING

TO PREVENT SERIOUS INJURY FROM ACCIDENTAL OPERATION:

Close the valve on the propane tank, allow the product to cool for at least 30 minutes, and disconnect the propane tank before performing any procedure in this section.

TO PREVENT SERIOUS INJURY FROM TOOL FAILURE:

Do not use damaged equipment. If abnormal noise or vibration occurs, have the problem corrected before further use.

1. **BEFORE EACH USE**, inspect the general condition of the product. Check for:
 - tightness of all gas fittings,
 - loose hardware,
 - misalignment or binding of moving parts,
 - cracked or broken parts,
 - any other condition that may affect its safe operation.
2. **BEFORE EACH USE**, perform a leak test using soapy water, see number 4 on page 8.
3. **AFTER USE**, wipe external surfaces of the tool with clean cloth.
4. **STORE** this product in a clean, dry location out of reach of children. If storing indoors, first shut off and remove the propane tank and leave it outdoors.

PLEASE READ THE FOLLOWING CAREFULLY

THE MANUFACTURER AND/OR DISTRIBUTOR HAS PROVIDED THE PARTS LISTS AND ASSEMBLY DIAGRAMS IN THIS MANUAL AS REFERENCE TOOLS ONLY. NEITHER THE MANUFACTURER OR DISTRIBUTOR MAKES ANY REPRESENTATION OR WARRANTY OF ANY KIND TO THE BUYER THAT HE OR SHE IS QUALIFIED TO MAKE ANY REPAIRS TO THE PRODUCT, OR THAT HE OR SHE IS QUALIFIED TO REPLACE ANY PARTS OF THE PRODUCT. IN FACT, THE MANUFACTURER AND/OR DISTRIBUTOR EXPRESSLY STATES THAT ALL REPAIRS AND PARTS REPLACEMENTS SHOULD BE UNDERTAKEN BY CERTIFIED AND LICENSED TECHNICIANS, AND NOT BY THE BUYER. THE BUYER ASSUMES ALL RISK AND LIABILITY ARISING OUT OF HIS OR HER REPAIRS TO THE ORIGINAL PRODUCT OR REPLACEMENT PARTS THERETO, OR ARISING OUT OF HIS OR HER INSTALLATION OF REPLACEMENT PARTS THERETO.

56061 Parts List and Diagram

SAFETY

Part	Description	Qty
1	Gas Control Set	1
2	Handle	1
3	Handle Tube	1
4	Handle Connector	1
5	Clamp	1
6	Small Nozzle	1

Part	Description	Qty
7	Bent Pipe	1
8	Extension Joint	1
9	Nozzle	1
10	Burner	1
11	Wrench	1
12	Hose	1

SETUP

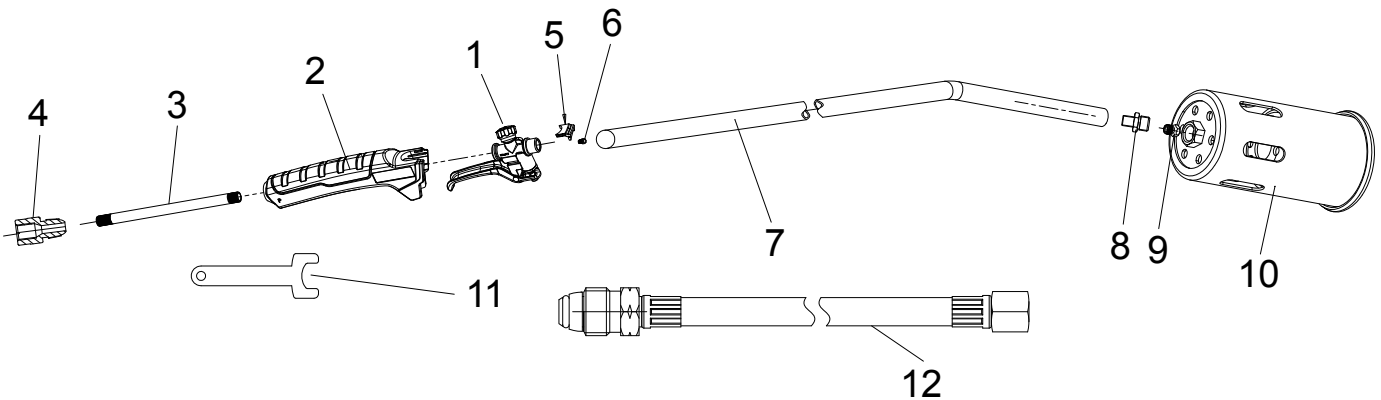

OPERATION

MAINTENANCE

Record Product's Serial Number Here: _____

Note: If product has no serial number, record month and year of purchase instead.

Note: Some parts are listed and shown for illustration purposes only, and are not available individually as replacement parts. Parts may not be interchangeable. Specify item number when ordering.

56062 Parts List and Diagram

Part	Description	Qty
1	Gas Control Set	1
2	Handle	1
3	Handle Tube	1
4	Handle Connector	1
5	Clamp	1
6	Small Nozzle	1
7	Hex Connector	1
8	Conical Nut	1
9	Igniter	1
10	Igniter Holder	1
11	Hex Screw	1
12	Hex Lock Nut	1
13	Bent Pipe	1

Part	Description	Qty
14	Heat Shrink Tube	1
15	Ignition Needle	1
16	Heat Shrink Tube	1
17	Extension Joint	1
18	Nozzle	1
19	Nozzle Cover	1
20	Ignition Needle	1
21	Burner	1
22	M4 Screw and M4 Spring Pad	1
23	Spring Pin	1
24	Wrench	1
25	Hose	1

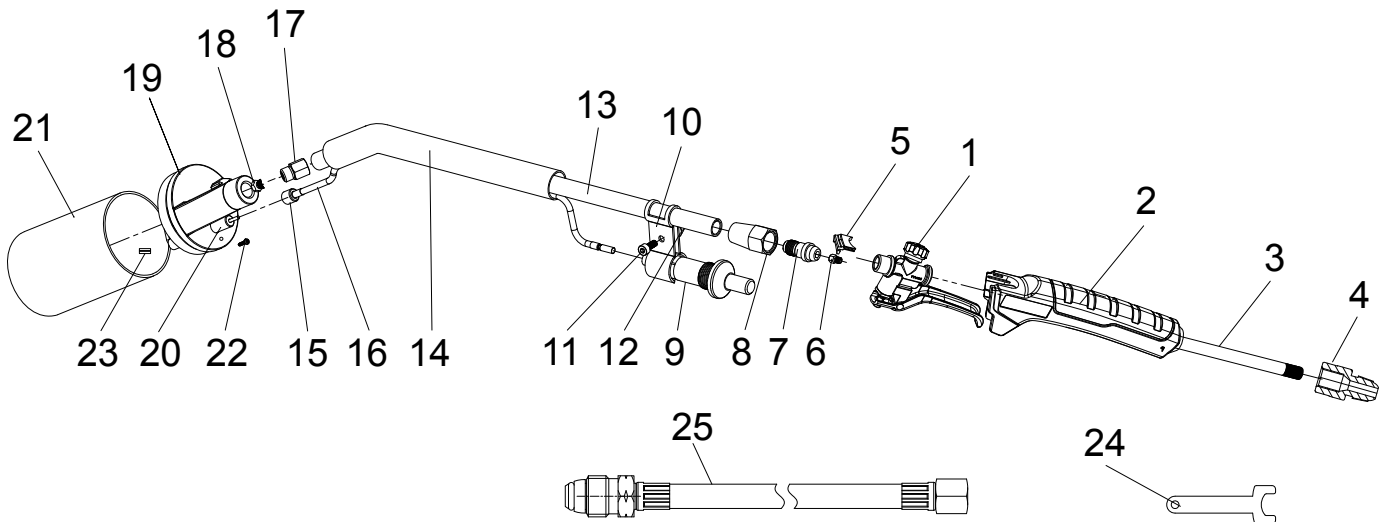

SAFETY

SETUP

OPERATION

MAINTENANCE

Limited 90 Day Warranty

Harbor Freight Tools Co. makes every effort to assure that its products meet high quality and durability standards, and warrants to the original purchaser that this product is free from defects in materials and workmanship for the period of 90 days from the date of purchase. This warranty does not apply to damage due directly or indirectly, to misuse, abuse, negligence or accidents, repairs or alterations outside our facilities, criminal activity, improper installation, normal wear and tear, or to lack of maintenance. We shall in no event be liable for death, injuries to persons or property, or for incidental, contingent, special or consequential damages arising from the use of our product. Some states do not allow the exclusion or limitation of incidental or consequential damages, so the above limitation of exclusion may not apply to you. THIS WARRANTY IS EXPRESSLY IN LIEU OF ALL OTHER WARRANTIES, EXPRESS OR IMPLIED, INCLUDING THE WARRANTIES OF MERCHANTABILITY AND FITNESS.

To take advantage of this warranty, the product or part must be returned to us with transportation charges prepaid. Proof of purchase date and an explanation of the complaint must accompany the merchandise. If our inspection verifies the defect, we will either repair or replace the product at our election or we may elect to refund the purchase price if we cannot readily and quickly provide you with a replacement. We will return repaired products at our expense, but if we determine there is no defect, or that the defect resulted from causes not within the scope of our warranty, then you must bear the cost of returning the product.

This warranty gives you specific legal rights and you may also have other rights which vary from state to state.



GREENWOOD™

26541 Agoura Road • Calabasas, CA 91302 • 1-888-866-5797