

Owner's Manual & Safety Instructions

Save This Manual Keep this manual for the safety warnings and precautions, assembly, operating, inspection, maintenance and cleaning procedures. Write the product's serial number in the back of the manual (or month and year of purchase if product has no number). Keep this manual and the receipt in a safe and dry place for future reference.

22e

JUPITER[®]

PURE

2000 WATT

PURE SINE WAVE INVERTER



Visit our website at: <http://www.harborfreight.com>
Email our technical support at: productsupport@harborfreight.com

57272

When unpacking, make sure that the product is intact and undamaged. If any parts are missing or broken, please call 1-888-866-5797 as soon as possible.

⚠ WARNING

Read this material before using this product. Failure to do so can result in serious injury. **SAVE THIS MANUAL.**

Copyright © 2020 by Harbor Freight Tools®. All rights reserved.
No portion of this manual or any artwork contained herein may be reproduced in any shape or form without the express written consent of Harbor Freight Tools. Diagrams within this manual may not be drawn proportionally. Due to continuing improvements, actual product may differ slightly from the product described herein. Tools required for assembly and service may not be included.

Specifications

Input	Voltage	12.5 VDC (rated)
	Internal Fuses	40 A x 8
	Current	188 A (rated)
Output	Continuous	2000W
	Surge	4000W
	Receptacles	2 AC GFCI outlets, 1 USB port
	Waveform	Pure Sine Wave *
	Voltage Range	115 VAC (rated)
	Frequency	60Hz
	Current	17.4 A (rated)





No Load Current (Switch on)	(≤0.8A)
Maximum Efficiency	92%
Full Load Efficiency	>85%
Over Voltage Shutdown	15-16.5 VDC
Low Voltage Alarm	10-11 VDC
Low Voltage Shutdown	9.5-10.5 VDC
Thermal Shutdown	150.8°F
Operating Temperature	32 - 104° F

Note: Battery charge level, wire length and other factors will affect performance.

*THD - No Load: 2.8%, 50% Load: 4.4%, Full Load: 6.3%

JUPITER®

WARNING SYMBOLS AND DEFINITIONS

	This is the safety alert symbol. It is used to alert you to potential personal injury hazards. Obey all safety messages that follow this symbol to avoid possible injury or death.
	Indicates a hazardous situation which, if not avoided, will result in death or serious injury.
	Indicates a hazardous situation which, if not avoided, could result in death or serious injury.
	Indicates a hazardous situation which, if not avoided, could result in minor or moderate injury.
	Addresses practices not related to personal injury.

IMPORTANT SAFETY INSTRUCTIONS

⚠️WARNING

SAVE THESE INSTRUCTIONS–

This manual contains important instructions that shall be followed during installation and maintenance of the Inverter.

IMPROPER INSTALLATION OR USE CAN RESULT IN SERIOUS INJURY, PROPERTY DAMAGE, OR DEATH.

General Precautions

1. People with pacemakers should consult their physician(s) before use. Electromagnetic fields in close proximity to heart pacemaker could cause pacemaker interference or pacemaker failure.
2. The warnings, precautions, and instructions discussed in this instruction manual cannot cover all possible conditions and situations that may occur. It must be understood by the operator that common sense and caution are factors which cannot be built into this product, but must be supplied by the operator.

Installation Precautions

1. **DO NOT INSTALL THIS INVERTER INTO A BUILDING'S ELECTRICAL SYSTEM. This Inverter is a vehicular accessory. It is not designed to be safely used in a building's electrical system and has not been evaluated to meet building wiring codes. Improper application may create a fire or electric shock hazard.**
2. To allow proper cooling, install in indoor well-ventilated area and do not cover ventilation openings or cooling fins. Do not install in engine compartment. **Especially avoid placing the Inverter on carpets and rugs; they are not only flammable, but they also obstruct vents underneath it.**
3. Keep combustible materials and gasses away from the Inverter. The Inverter produces sparks and heat during operation and can start a fire.
4. Connect to 12 VDC power supply only. A power supply with lower voltage will not operate the Inverter correctly, and higher voltage could damage the Inverter.
5. Connect input polarity properly. Incorrect connection will damage Inverter and void warranty.
6. **Do not use in a marine application.** This Inverter is not intended to withstand the highly corrosive conditions in marine applications and would quickly be rendered inoperable or unsafe.
7. Keep Inverter dry and clean. Do not expose to rain, snow, spray, bilge water or dust.
8. Use cables that are thick enough. The more power (amps) or the longer the cables, the thicker they need to be to prevent overheating and fire.
9. Install as close to DC source as possible, but not in a closed area with vented lead-acid batteries. Vented lead-acid batteries release explosive hydrogen gas that can be ignited by the Inverter.
10. Mount Inverter horizontally.
11. Verify that installation surface has no hidden utility lines before drilling or driving screws.
12. This product is not a toy. Keep it out of reach of children.
13. Do not use with positive ground electrical systems. (Most automobiles, trucks, and RV's have negative ground systems.)
14. The positive (+) battery on the Inverter must be the last connection made, and must be connected before the Inverter is turned on. There may be a small spark during the final connection. This is normal.
15. Properly ground the Inverter's case as explained in this manual.

Battery Precautions

1. **Wear splash-resistant ANSI-approved safety goggles and electrically-insulated gloves while working near batteries.**
2. Charge, store, and maintain batteries according to supplier's instructions.
3. Locate batteries in a clean, well-ventilated area, away from ignition sources and flammable materials. Vented lead-acid batteries release explosive hydrogen gas while charging.
4. Only connect similar batteries together. Do not connect old and new batteries together, flooded and gel cells together, or batteries of different capacities together.
5. **Use only 12 V batteries with this item.**
6. **Connect batteries in parallel ONLY (negative terminals together to one cable; positive terminals together to the other cable).**
7. **Install a properly rated fuse on the positive output of the battery bank.**

Operation Precautions

1. Multiple outlet power strips with switches and circuit breakers only interrupt power to the "hot" receptacle terminals. The "neutral" terminals remain powered with respect to the "ground" terminals. So strip switch may be off, but part of device may still be powered.
2. Inspect supply connections before use to ensure they are tight and that insulation is not damaged.
3. Do not use this Inverter to power sensitive devices such as medical devices or plug-in computers. Do not use in ignition protected areas.
4. Some rechargeable devices can damage the Inverter. Check the temperature of the device several times when it is charging. If the device becomes extremely hot; turn the power off, remove the device, and do not use with the Inverter again.
5. Check for breakage of parts and any other condition that may affect the Inverter's operation. If damaged, have it repaired before use.
6. Do not attempt to power a device, or combination of devices, that will require more than the rated output of this Inverter. This may damage the Inverter or the attached devices.
7. Appliances such as microwave ovens will normally draw more than their rated current. For example: A typical 600 watt microwave oven will draw approximately 1,000 watts.
8. Do not attach a battery charger if the charger carries a warning that dangerous voltages are present at the battery terminals.
9. Some fluorescent lamps may not operate properly with this type of Inverter. If the bulb appears to be too bright, or fails to light, do not use the lamp with this Inverter.
10. Some fans with synchronous motors may slightly increase in speed when powered by the Inverter. This is not harmful to the fan or to the Inverter.
11. Inverter will consume some power while on, even without loads attached. Turn Inverter off after use.





Service Precautions

1.  **DO NOT OPEN HOUSING.** Contains no user-serviceable parts. **Internal parts may be electrified, even with Inverter off and power disconnected.**
2. Maintain labels and nameplates on the Inverter. These carry important safety information. If unreadable or missing, contact Harbor Freight Tools for a replacement.
3. **Have your Inverter serviced by a qualified repair person using only identical replacement parts. This will ensure that the safety of the Inverter is maintained.**
4. **Fuses must be replaced with fuses of the same type and rating only.**



SAVE THESE INSTRUCTIONS.

Symbology

	Double Insulated	A	Amperes
VAC	Volts Alternating Current		Phase
	Alternating Current Supply		Equipment Grounding Conductor
	Direct Current Supply		

FCC

This device complies with part 15 of the FCC Rules. Operation is subject to the following two conditions:

- (1) This device may not cause harmful interference, and
- (2) this device must accept any interference received, including interference that may cause undesired operation.

Typical Device Power Consumption

Product	Wattage	Product	Wattage	Product	Wattage
Laptop	50	Belt Sander	350	Chest Freezer	800
Stereo	200	3/8" Drill	350	Coffee Maker	850
Mixer	200	Blender	350	Iron	1050
Table Fan	200	Laser Printer	400	Mini Microwave	1200
TV-VCR	250	Food Processor	400	Hair Dryer	1200
Plug-in computer	250	Reciprocating Saw	600	10" Saw	1350
Small Refrigerator	350	AC (5,000 BTU)	700		
Jigsaw	350	Vacuum	750		

Note: The above chart is intended as a general guideline only, actual device wattage requirements will vary.

JUPITER®

Output waveform

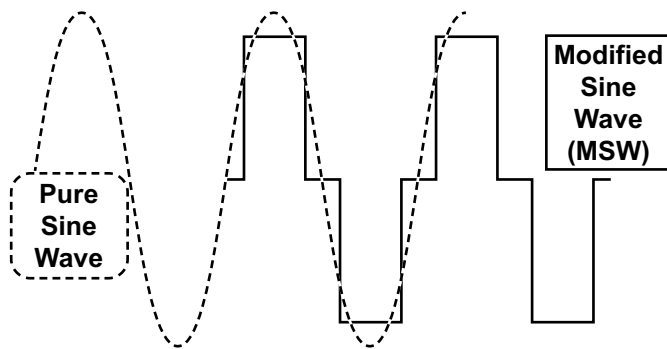

1. This Inverter's output is a Pure Sine Wave. Power from most electric utilities is also Sine Wave.

2. **Modified Sine Wave (MSW)** power is suitable for most AC devices and power supplies used in electronic equipment, transformers, and motors. Do not use to power sensitive devices such as medical equipment or plug-in computers. Some audio equipment may perform poorly if run on Modified Sine Wave power.
3. **Pure Sine Wave** Inverters provide power that is identical to, or even better than, the power supplied by your power company. Motors start easier and run cooler under Sine Wave power. Certain devices, such as laser printers, variable speed motors and digital clocks, require sine wave power to operate properly. Pure Sine Wave Inverters are typically more expensive for their capacity than other Inverters.

Installation



Read the **ENTIRE IMPORTANT SAFETY INFORMATION** section at the beginning of this document including all text under subheadings therein before set up or use of this product.

CAUTION

This Inverter must only be connected to batteries with a output voltage of 12 volts DC. Lower voltage will not operate the Inverter properly, and more voltage could damage the Inverter or the device being powered. Do not use this Inverter with positive ground electrical systems.

Inverter

The Inverter has a number of shut-down points, for the safety of the operator, the Inverter, and the devices being used with it.

- If the DC input voltage drops too low, the alarm on the Inverter will sound. If the input voltage drops further, the Inverter will shut down automatically to prevent permanent battery damage. Recharge the battery soon.
- If the DC input voltage exceeds 15-16.5V the Inverter will shut down automatically.
- If the output load power rises higher than the rating power of the Inverter; the Inverter may shut down automatically.
- The Inverter may automatically shut down if its internal temperature gets too high.

Note: Even though this Inverter has built-in mechanisms to minimize damage, these situations should be avoided because they can still damage the Inverter or battery.

1. Place the Inverter on a dry, level, non-flammable, stable surface. Make sure the Inverter has adequate ventilation and is not in direct sunlight.
2. Connect one end of a ground wire (not included, use at least recommended wire thickness from specification chart) to the wing nut located on the back of the Inverter. Then connect the other end of the ground wire to a paint/rust free grounded metal surface, such as the vehicle chassis.
3. Battery Type Selection:
 - Use only deep cycle lead-acid batteries with this Inverter, such as 12 volt marine/RV deep-cycle batteries. Do not use automotive, engine starting (SLI), or maintenance-free wet cell batteries with this Inverter; they are designed for repeated, shallow discharge and will wear out quickly.
 - Gel and AGM (Absorbed Glass Mat) batteries can be used with this Inverter, but they require special charging procedures. Refer to battery supplier's instructions.

4. Battery capacity selection:

Inverter Output	about 1 hour discharge time (Minimum battery capacity)	about 4 hour discharge time (Optimal battery capacity)
500W	80 Ah	200 Ah
1000W	150 Ah	400 Ah
1500W	240 Ah	700 Ah
2000W	300 Ah	1000 Ah
3000W	450 Ah	1500 Ah
4000W	600 Ah	2000 Ah
5000W	750 Ah	2500 Ah

Consult the chart above for approximate run time at different battery capacities. If the battery does not have a capacity this large individually, use a bank of batteries as explained below.

5. Battery Bank assembly instructions:

a. Read the following safety rules before assembling the battery bank:

- Connect batteries in parallel (negative terminals together to one cable; positive terminals together to the other cable) as shown in Battery Bank Example ONLY.
- Do not connect 12V batteries in series (from negative of one battery to the positive of the next). This connection can result in voltage high enough to cause ELECTROCUTION.
- Wear splash-resistant ANSI-approved safety goggles and electrically insulated gloves while assembling battery bank.
- Only connect similar batteries together in a battery bank. Do not connect old and new batteries together, flooded and gel cells together, or batteries of different capacities together.
- Connect all batteries in the battery bank together using cables of the thickness recommended on the specification chart or thicker. Since amp draw on this low-voltage circuit will be very high, thinner cables present a fire hazard.
- Locate battery bank in a clean, well-ventilated area, away from ignition sources and flammable materials. Batteries release explosive hydrogen gas while charging.
- Charge, store, and maintain batteries according to supplier's instructions.

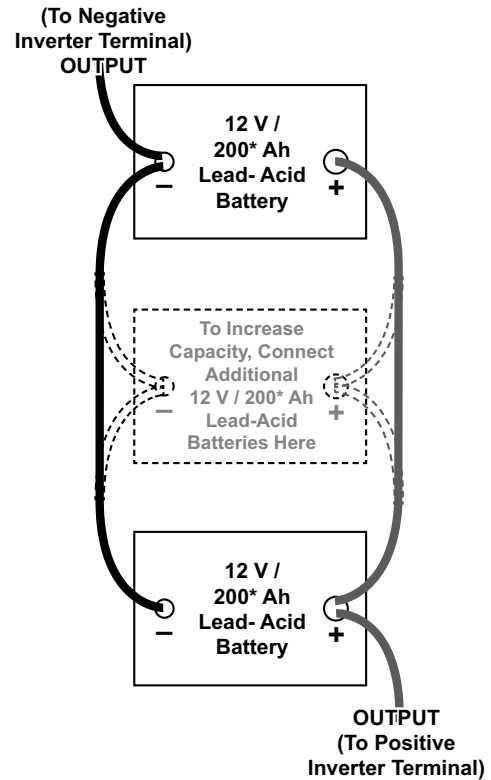

12 V / 400[^] Ah Battery Bank Example

* 200 Ah batteries shown for illustration.

[^] Bank Capacity = (single battery capacity) x (# of batteries) 400 Ah capacity is for two, 200 Ah batteries.

- b. Connect the batteries in parallel as shown above. Connect all of the positive terminals to one another.
 - c. Then connect all the negative terminals to one another.
 - d. Connect the negative and positive output cables to opposite ends of the bank. **Do not allow the output cables to touch one another.**
 - e. Test the voltages at the output cables to help ensure that the battery bank is properly wired. If the voltage is higher than 13 volts, then part of the battery bank is likely connected in series (a negative terminal of one battery attached to a positive terminal of another) instead of in parallel. Carefully examine the diagram and correct the wiring before attaching to the Inverter.
6. Turn the Inverter off.
 7. Connect the output cables from the battery bank to the Inverter.

Remote Control

Installation

1. Turn Inverter off.
2. Choose location that is clean, dry and free from corrosive or explosive fumes. Verify the location has no hidden utility lines before drilling or driving screws.
 - a. If the Remote used in a home, mount to drywall.
 - b. If the Remote used in a vehicle, mount inside the cab or other convenient location.
3. Mark hole locations using included template.
 - a. Cut an opening for the Remote using the dimensions below (dashed line). Be sure there is depth clearance of 2" (50.8mm) to accommodate the back of the Remote and cables.
 - b. Drill four pilot holes for the included four screws.

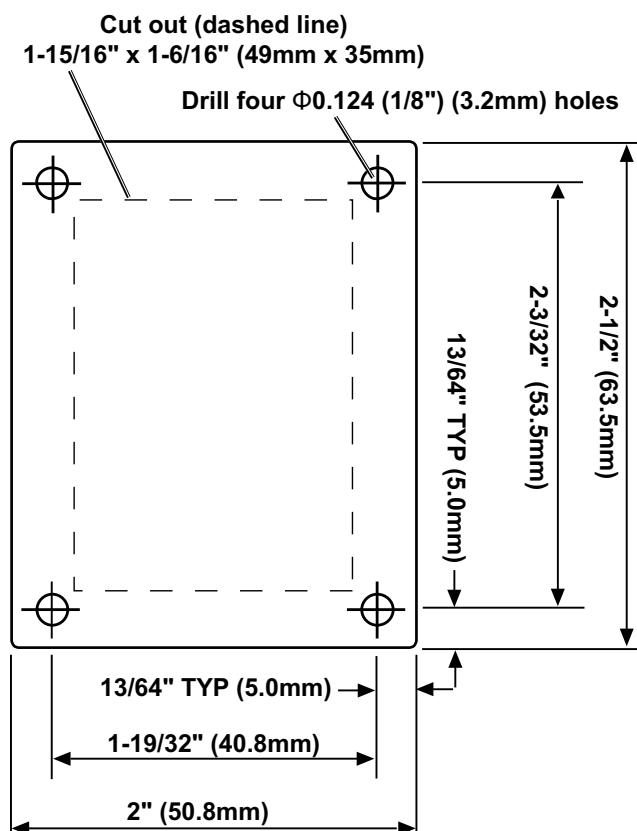

Remote Mounting Holes and Cut Out

4. Run wires in a Building.

- a. Route the RJ11 cable inside the wall. Connect it from the Remote's RJ11 Com Port to the Inverter's 'Remote On/Off' Port.
- b. If using the **Remote in a home**, set the Ignition Lockout switch on the back of the Remote to Disable and do not connect the Vehicle ACC Ignition Wire.
- c. If using the **Remote in a vehicle**:
 - To enable the Ignition Lockout feature, set the Ignition Lockout switch on the back of the Remote to Enable.
 - Connect the Vehicle ACC Ignition Wire on back of Remote to the vehicle's ACC wire according to vehicle owner's manual.
 - Do not connect the Vehicle ACC Ignition Wire and set the switch to Disable if you do not wish to use the feature.

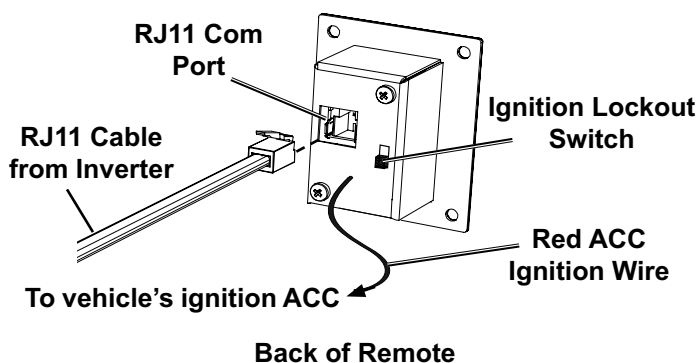

5. Place the Remote into the opening. Secure the Remote with the included screws.

Note: The **Ignition Lockout** feature, when enabled, does not allow the Remote to power on the Inverter when the vehicle's ignition switch is off.

Operating Instructions

Inverter

1. Plug 120 VAC device(s) into the receptacles. Switch all devices off. The devices must not use more than the rated wattage during continuous operation, otherwise they may overload the Inverter.
2. Turn the Inverter on.

NOTE: Some rechargeable devices may damage the Inverter or the device(s). When first using a rechargeable device, check the Inverter's temperature for the first ten minutes. If it becomes abnormally hot, do not use the device with the Inverter. Front Panel

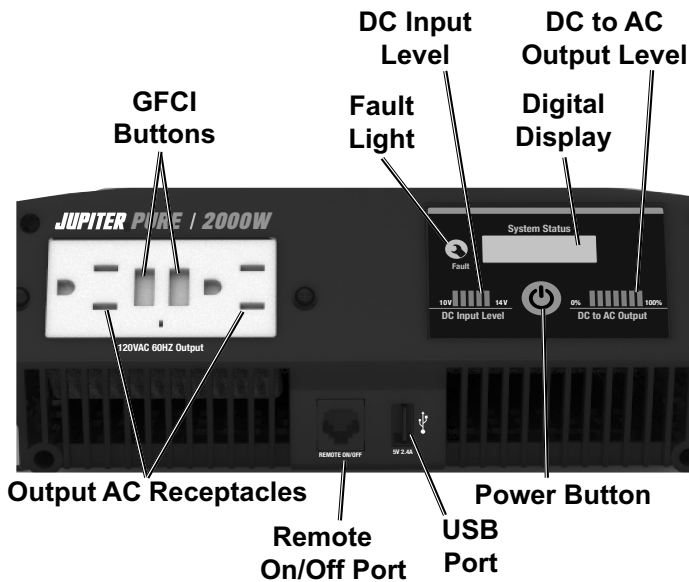

- Turn the device(s) on, one at a time. If the alarm sounds, turn off the device(s). Unplug the device(s) from the Inverter. Check the wattage of the devices, if there were multiple devices plugged in, discontinue use of one or more. If a single device sets the alarm off, it is not appropriate for use with the Inverter.
- If a problem occurs, the Fault light will illuminate and the Digital Display will turn red. A message will appear and the alarm will be heard.

LOW DC ALARM Displays when the battery input is below 10-11 VDC.

The Inverter's output will automatically shut off when the messages below appear:

LOW DC SHUTOFF Displays when the battery input is below 9.5-10.5 VDC.

HI DC SHUTOFF Displays when the battery input is above 15-16.5 VDC.

OVERLOAD SHUTOFF Displays when the load on the Inverter is more than 105%.

HI TEMP SHUTOFF Displays when the Inverter's internal temperature is above 150.8°F.

- The DC Input Level displays the current input voltage of the battery from 10V to 14V. The LEDs in the graph will remain green when voltage levels are within range.
- The DC to AC Output Level displays the used power capacity of the Inverter from 0% to 100%. The LEDs in the graph will remain green when the used power is within operating limits.

- When the Inverter is turned on and operating normally, the Digital Display will indicate:

SYSTEM NORMAL

- Connect USB device to the USB Port on the front panel.
- If desired, connect Inverter Remote to the Remote On/Off Port on the front panel.

- If the Inverter is powered by a vehicle's starting battery, be careful not to discharge the battery to the point that it will no longer start the engine. If needed, operate the engine periodically to maintain the battery's charge. Do not operate a vehicle's engine in an enclosed space.
- Inverter will consume some power while on, even without loads attached. Turn Inverter off after use.

Remote Control

Testing

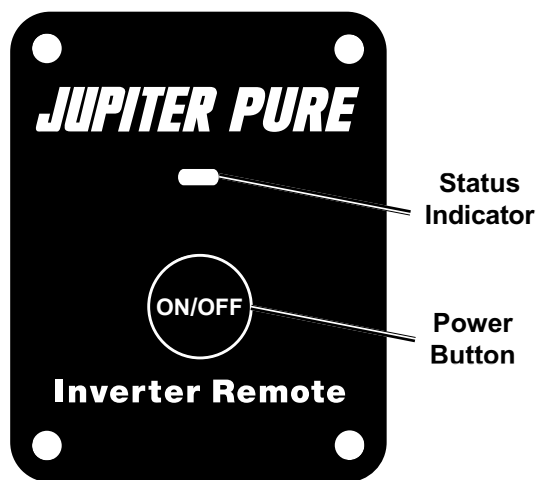

Front of Remote

- Press the Inverter's Power Button to power it on. Verify the Inverter's Display illuminates and the Remote's Status Indicator illuminates.
- Power the Inverter on. Verify it's Status Indicator lights.
- Press the Remote's Power Button to power off. Verify the Inverter powers off and the Remote's Status Indicator is off.
- Press the Remote's Power Button again. Verify the Inverter powers on and the Remote's Status Indicator lights.

Note: The Inverter will **not** power on if the Remote's Vehicle ACC Ignition Wire is connected and Ignition Lockout Switch is set to Enable but:

- the vehicle's ignition switch is off, or
- the vehicle's Ignition Switch is on but the ACC wire is not properly connected.

Maintenance and Servicing



Procedures not specifically explained in this manual must be performed only by a qualified technician.

WARNING

TO PREVENT SERIOUS INJURY FROM ELECTRIC SHOCK:

Turn the Inverter off and disconnect its power supply before performing any inspection, maintenance, or cleaning procedures.

TO PREVENT SERIOUS INJURY FROM INVERTER FAILURE:

Do not use damaged Inverter. If abnormal noise, vibration, or heating occurs, have the problem corrected before further use.

Wear splash-resistant ANSI-approved safety goggles and electrically insulated gloves while working near batteries.

- BEFORE EACH USE**, inspect the general condition of the Inverter. Check for:
 - loose hardware,
 - damaged electrical wiring,
 - cracked or broken parts, and
 - any other condition that may affect its safe operation.
- AFTER USE**, clean external surfaces of the Inverter with clean, dry cloth.
- Maintain batteries according to manufacturer's instructions. Check electrolyte level on all batteries after charging and refill as needed. **Charge batteries according to manufacturer's recommendations ONLY**; incorrect charging may cause battery damage or explosion.
-  **DO NOT OPEN HOUSING.** Contains no user-serviceable parts. **Internal parts may be electrified, even with Inverter off and power disconnected.**
- Store the Inverter in a clean, dry, safe location out of reach of children and other unauthorized people.
- Internal electronic components must be disposed of properly or recycled.

Troubleshooting

Problem	Possible Causes	Probable Solutions
Inverter shuts off during use.	<ol style="list-style-type: none"> 1. Excessive load at output. 2. Internal temperature is too high. 	<ol style="list-style-type: none"> 1. Reduce load to less than rated power. 2. Let the Inverter cool down for at least 30 minutes. Make sure that the fan is not blocked and that the Inverter has sufficient ventilation.
No output voltage.	<ol style="list-style-type: none"> 1. Cords not connected properly. 2. Fuse on battery bank open. 3. Internal fuse(s) open. 4. Low input voltage. 5. Loose or corroded connection. 6. High input voltage. 	<ol style="list-style-type: none"> 1. Check and secure connections. 2. Check battery bank fuse and replace as needed. 3. Have technician check internal fuses and replace as needed. Only a qualified technician should open housing. 4. Recharge or replace battery. 5. Clean and tighten connection. 6. Remove charging source and make sure correct battery is being used and connected correctly.
Output voltage is incorrect.	Input voltage is too high or too low.	Maintain input voltage at required level.
Could not drive load.	<ol style="list-style-type: none"> 1. Load power is too large. 2. The AWG of the wire is too low. 3. Start power of an device is up to twice the rated power. 	<ol style="list-style-type: none"> 1. Lower load level. 2. Use appropriately-sized wire connections. 3. Reduce load, or change devices.
Motor-operated device operates at incorrect speed.	Load is only inductive.	Operate a lamp or heater at the same time to provide a more balanced load.
Television picture is full of static or speakers make a buzz.	<ol style="list-style-type: none"> 1. Television or radio interference. 2. Incompatible device. 	<ol style="list-style-type: none"> 1. Move Inverter away from antenna and/ or use a shielded antenna cable. 2. Contact device supplier to make sure that device can operate on Modified Sine Wave Power.



Follow all safety precautions whenever diagnosing or servicing the Inverter. Disconnect power supply before service.

Record Product's Serial Number Here: _____

Note: If product has no serial number, record month and year of purchase instead.

Note: Replacement parts are not available for this product. Reference UPC 792363572729.

Limited 90 Day Warranty

Harbor Freight Tools Co. makes every effort to assure that its products meet high quality and durability standards, and warrants to the original purchaser that this product is free from defects in materials and workmanship for the period of 90 days from the date of purchase. This warranty does not apply to damage due directly or indirectly, to misuse, abuse, negligence or accidents, repairs or alterations outside our facilities, criminal activity, improper installation, normal wear and tear, or to lack of maintenance. We shall in no event be liable for death, injuries to persons or property, or for incidental, contingent, special or consequential damages arising from the use of our product. Some states do not allow the exclusion or limitation of incidental or consequential damages, so the above limitation of exclusion may not apply to you. THIS WARRANTY IS EXPRESSLY IN LIEU OF ALL OTHER WARRANTIES, EXPRESS OR IMPLIED, INCLUDING THE WARRANTIES OF MERCHANTABILITY AND FITNESS.

To take advantage of this warranty, the product or part must be returned to us with transportation charges prepaid. Proof of purchase date and an explanation of the complaint must accompany the merchandise. If our inspection verifies the defect, we will either repair or replace the product at our election or we may elect to refund the purchase price if we cannot readily and quickly provide you with a replacement. We will return repaired products at our expense, but if we determine there is no defect, or that the defect resulted from causes not within the scope of our warranty, then you must bear the cost of returning the product.

This warranty gives you specific legal rights and you may also have other rights which vary from state to state.

JUPITER®

26677 Agoura Road • Calabasas, CA 91302 • 1-888-866-5797