

# Owner's Manual & Safety Instructions

Save This Manual Keep this manual for the safety warnings and precautions, assembly, operating, inspection, maintenance and cleaning procedures. Write the product's serial number in the back of the manual near the assembly diagram (or month and year of purchase if product has no number). Keep this manual and the receipt in a safe and dry place for future reference.

20k

# Schneider™

## CORDED SOLDERING STATION



Visit our website at: <http://www.harborfreight.com>  
Email our technical support at: [productsupport@harborfreight.com](mailto:productsupport@harborfreight.com)

57364

When unpacking, make sure that the product is intact and undamaged. If any parts are missing or broken, please call 1-888-866-5797 as soon as possible.

Copyright© 2020 by Harbor Freight Tools®. All rights reserved.

No portion of this manual or any artwork contained herein may be reproduced in any shape or form without the express written consent of Harbor Freight Tools. Diagrams within this manual may not be drawn proportionally. Due to continuing improvements, actual product may differ slightly from the product described herein. Tools required for assembly and service may not be included.

### **⚠ WARNING**

Read this material before using this product. Failure to do so can result in serious injury. SAVE THIS MANUAL.

# Table of Contents

Safety .....	2	Maintenance .....	8
Specifications .....	6	Parts List and Diagram .....	10
Setup .....	6	Warranty .....	12
Operation .....	7		



## WARNING SYMBOLS AND DEFINITIONS

	This is the safety alert symbol. It is used to alert you to potential personal injury hazards. Obey all safety messages that follow this symbol to avoid possible injury or death.
	Indicates a hazardous situation which, if not avoided, will result in death or serious injury.
	Indicates a hazardous situation which, if not avoided, could result in death or serious injury.
	Indicates a hazardous situation which, if not avoided, could result in minor or moderate injury.
	Addresses practices not related to personal injury.

## IMPORTANT SAFETY INFORMATION

### General Power Tool Safety Warnings

#### WARNING

**Read all safety warnings and instructions.**

*Failure to follow the warnings and instructions may result in electric shock, fire and/or serious injury.*

**Save all warnings and instructions for future reference.**

*The term "power tool" in the warnings refers to your mains-operated (corded) power tool.*

### Work area safety

- Keep work area clean and well lit.**  
*Cluttered or dark areas invite accidents.*
- Do not operate power tools in explosive atmospheres, such as in the presence of flammable liquids, gases or dust.** *Power tools create sparks which may ignite the dust or fumes.*
- Keep children and bystanders away while operating a power tool.**  
*Distractions can cause you to lose control.*

## Electrical safety

---

- Power tool plugs must match the outlet. Never modify the plug in any way. Do not use any adapter plugs with grounded power tools.** *Unmodified plugs and matching outlets will reduce risk of electric shock.*
- Avoid body contact with grounded surfaces such as pipes, radiators, ranges and refrigerators.** *There is an increased risk of electric shock if your body is grounded.*
- Do not expose power tools to rain or wet conditions.** *Water entering a power tool will increase the risk of electric shock.*
- Do not abuse the cord. Never use the cord for carrying, pulling or unplugging the power tool. Keep cord away from heat, oil, sharp edges or moving parts.** *Damaged or entangled cords increase the risk of electric shock.*
- If operating a power tool in a damp location is unavoidable, use a Ground Fault Circuit Interrupter (GFCI) protected supply.** *Use of a GFCI reduces the risk of electric shock.*

## Personal safety

---

- Stay alert, watch what you are doing and use common sense when operating a power tool. Do not use a power tool while you are tired or under the influence of drugs, alcohol or medication.** *A moment of inattention while operating power tools may result in serious personal injury.*
- Use personal protective equipment. Always wear eye protection.** *Safety equipment such as dust mask, non-skid safety shoes, hard hat, or hearing protection used for appropriate conditions will reduce personal injuries.*
- Prevent unintentional starting. Ensure the Trigger is in the off-position before connecting to power source, picking up or carrying the tool.** *Carrying power tools with your finger on the Trigger or energizing power tools that have the Trigger on invites accidents.*
- Do not overreach. Keep proper footing and balance at all times.** *This enables better control of the power tool in unexpected situations.*
- Dress properly. Do not wear loose clothing or jewelry. Keep your hair, clothing and gloves away from hot parts.**
- Only use safety equipment that has been approved by an appropriate standards agency.** *Unapproved safety equipment may not provide adequate protection. Eye protection must be ANSI-approved and breathing protection must be NIOSH-approved for the specific hazards in the work area.*

## Power tool use and care

---

- Do not force the power tool. Use the correct power tool for your application.** *The correct power tool will do the job better and safer at the rate for which it was designed.*
- Do not use the power tool if the Trigger does not turn it on and off.** *Any power tool that cannot be controlled with the Trigger is dangerous and must be repaired.*
- Disconnect the plug from the power source before making any adjustments, changing accessories, or storing power tools.** *Such preventive safety measures reduce the risk of starting the power tool accidentally.*
- Store idle power tools out of the reach of children and do not allow persons unfamiliar with the power tool or these instructions to operate the power tool.** *Power tools are dangerous in the hands of untrained users.*
- Maintain power tools. Check for misalignment or binding of moving parts, breakage of parts and any other condition that may affect the power tool's operation. If damaged, have the power tool repaired before use.** *Many accidents are caused by poorly maintained power tools.*
- Use the power tool, accessories and tool bits etc. in accordance with these instructions, taking into account the working conditions and the work to be performed.** *Use of the power tool for operations different from those intended could result in a hazardous situation.*

## Service

Have your power tool serviced by a qualified repair person using only identical replacement parts. This will ensure that the safety of the power tool is maintained.

## Specific Safety Rules

1. **Avoid Serious Burns.** The Soldering Iron has a temperature range of 392° F - 896° F. Do not point the Soldering Iron, or turn yourself toward another person while soldering.
2. **Do not open Soldering Iron.** Do not attempt to open and repair this unit. It must be serviced by a qualified technician.
3. **To prevent electric shock, always de-energize any circuits or wires to be soldered before making connections and soldering.**
4. **Exposure to soldering fumes can increase the risk of developing certain cancers, such as cancer of the larynx and lung cancer.** Also, some diseases that may be linked to exposure to soldering fumes are:
  - Early onset of Parkinson's Disease
  - Heart disease
  - Ulcers
  - Damage to the reproductive organs
  - Inflammation of the small intestine or stomach
  - Kidney damage
  - Respiratory diseases such as emphysema, bronchitis, or pneumonia
5. **Keep head out of fumes.** Do not breathe soldering fumes. Use enough ventilation to keep fumes and gases from breathing zone and general area.
6. **Never lay the Soldering Iron down where the heated parts can contact flammable materials or electrical wires.**
7. **This product is not a toy.** Keep it out of reach of children.
8. **Maintain labels and nameplates on the tool.** These carry important safety information. If unreadable or missing, contact Harbor Freight Tools for a replacement.
9. **Do not leave the tool unattended when it is plugged into an electrical outlet.** Turn off the tool, and unplug it from its electrical outlet before leaving.
10. The warnings, precautions, and instructions discussed in this instruction manual cannot cover all possible conditions and situations that may occur. It must be understood by the operator that common sense and caution are factors which cannot be built into this product, but must be supplied by the operator.



**SAVE THESE INSTRUCTIONS.**

## Grounding

### **⚠ WARNING**



**TO PREVENT ELECTRIC SHOCK AND DEATH FROM INCORRECT GROUNDING WIRE CONNECTION:**

Check with a qualified electrician if you are in doubt as to whether the outlet is properly grounded. Do not modify the power cord plug provided with the tool. Never remove the grounding prong from the plug. Do not use the tool if the power cord or plug is damaged. If damaged, have it repaired by a service facility before use. If the plug will not fit the outlet, have a proper outlet installed by a qualified electrician.

# Grounded Tools: Tools with Three Prong Plugs

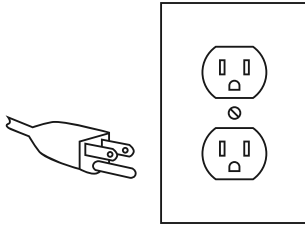

**3-Prong Plug and Outlet**

- Tools marked with "Grounding Required" have a three wire cord and three prong grounding plug. The plug must be connected to a properly grounded outlet. If the tool should electrically malfunction or break down, grounding provides a low resistance path to carry electricity away from the user, reducing the risk of electric shock. **(See 3-Prong Plug and Outlet.)**
- The grounding prong in the plug is connected through the green wire inside the cord to the grounding system in the tool. The green wire in the cord must be the only wire connected to the tool's grounding system and must never be attached to an electrically "live" terminal. **(See 3-Prong Plug and Outlet.)**
- The tool must be plugged into an appropriate outlet, properly installed and grounded in accordance with all codes and ordinances. The plug and outlet should look like those in the preceding illustration. **(See 3-Prong Plug and Outlet.)**





## Extension Cords

- Grounded** tools require a three wire extension cord. **Double Insulated** tools can use either a two or three wire extension cord.
- As the distance from the supply outlet increases, you must use a heavier gauge extension cord. Using extension cords with inadequately sized wire causes a serious drop in voltage, resulting in loss of power and possible tool damage. **(See Table A.)**
- The smaller the gauge number of the wire, the greater the capacity of the cord. For example, a 14 gauge cord can carry a higher current than a 16 gauge cord. **(See Table A.)**
- When using more than one extension cord to make up the total length, make sure each cord contains at least the minimum wire size required. **(See Table A.)**
- If you are using one extension cord for more than one tool, add the nameplate amperes and use the sum to determine the required minimum cord size. **(See Table A.)**
- If you are using an extension cord outdoors, make sure it is marked with the suffix "W-A" ("W" in Canada) to indicate it is acceptable for outdoor use.
- Make sure the extension cord is properly wired and in good electrical condition. Always replace a damaged extension cord or have it repaired by a qualified electrician before using it.
- Protect the extension cords from sharp objects, excessive heat, and damp or wet areas.

NAMEPLATE AMPERES (at full load)	EXTENSION CORD LENGTH				
	25'	50'	75'	100'	150'
0 – 2.0	18	18	18	18	16
2.1 – 3.4	18	18	18	16	14
3.5 – 5.0	18	18	16	14	12
5.1 – 7.0	18	16	14	12	12
7.1 – 12.0	18	14	12	10	-
12.1 – 16.0	14	12	10	-	-
16.1 – 20.0	12	10	-	-	-

**\* Based on limiting the line voltage drop to five volts at 150% of the rated amperes.**

# Symbology

<b>V</b>	Volts		Read the manual before set-up and/or use.
~	Alternating Current		WARNING marking concerning Risk of Fire. Do not cover ventilation ducts. Keep flammable objects away.
<b>A</b>	Amperes		WARNING marking concerning Risk of Electric Shock. Properly connect power cord to appropriate outlet.
	WARNING marking concerning Risk of Eye Injury. Wear ANSI-approved safety goggles with side shields.		

SAFETY

## Specifications

Electrical Rating	120 VAC / 60 Hz / 50 W
Temperature Range	392° F - 896° F
Tip Leakage Voltage	<2mV
Soldering Tips	900M Conical: 0.2mm, 0.5mm, 0.8mm

SETUP

## Setup - Before Use:

## Components and Controls

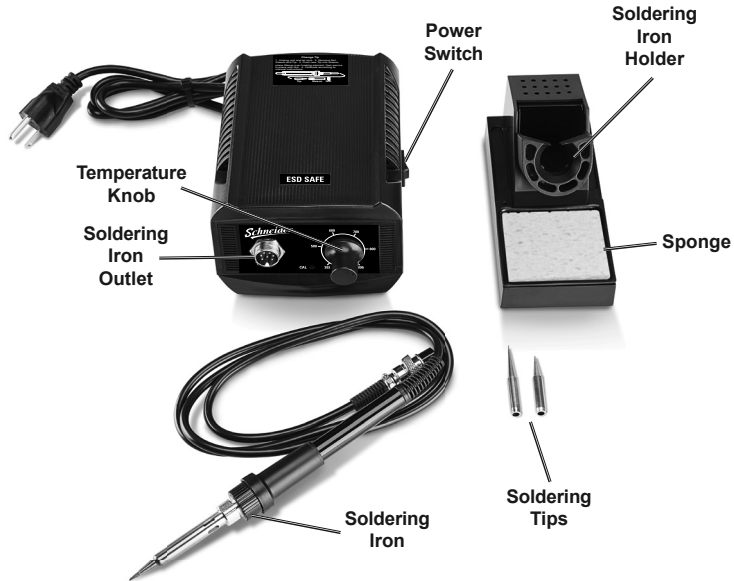

OPERATION

MAINTENANCE

## Operating Instructions



Read the **ENTIRE IMPORTANT SAFETY INFORMATION** section at the beginning of this manual including all text under subheadings therein before set up or use of this product.

**Note:** For additional information regarding the parts listed in the following pages, refer to *Parts List and Diagram* on page 10.

## Workpiece and Work Area Set Up

1. Designate a work area that is clean and well-lit. The work area must not allow access by children or pets to prevent distraction and injury.
2. Route the power cord along a safe route to reach the work area without creating a tripping hazard or exposing the power cord to possible damage. The power cord must reach the work area with enough extra length to allow free movement while working.
3. There must not be objects, such as utility lines, nearby that will present a hazard while working.
4. If wires are to be soldered, thoroughly clean or scrape the wires so that only the clean metal is showing, then make the wire splice.
5. If other objects are to be soldered, thoroughly clean or scrape the metal surfaces. It may be necessary to apply acid flux (not included) to the metal surfaces before soldering.

**Notice:** If soldering on printed circuit boards, too much heat can soften the plastic form and loosen the metal eyelet connections. Use minimal heat. Never use acid-core solder on wiring circuits.

## Tool Set Up

### **⚠ WARNING**

**TO PREVENT SERIOUS INJURY FROM ACCIDENTAL OPERATION:**

**Unplug the tool from its electrical outlet before performing any procedure in this section.**

**Note:** Practice soldering on scrap wires and splices prior to actual use.

1. Set the Soldering Station on a fireproof workbench away from all flammable materials.
2. Unplug unit, then plug Soldering Iron into Soldering Iron Outlet and tighten nut securely.
3. Install Soldering Tip according to **Maintenance and Servicing on page 8**.
4. Wet Sponge with water and wring out until damp. Place sponge in Soldering Iron Holder.

## General Operating Instructions

### **⚠ WARNING**

**TO PREVENT SERIOUS INJURY:**

**Wear ANSI-approved safety goggles with side shields.**

1. Plug the Power Cord into a grounded 120VAC outlet.
2. Turn the Power Switch on and set temperature.
3. Clean and tin Tip, apply a sufficient amount of rosin-core solder to melt over the entire Soldering Tip. Wipe the Tip on the sponge until the Tip is clean and shiny.
4. Apply solder to the wire splice or metal to be soldered, not the Soldering Tip. When the splice or metal is hot enough, it will melt the solder causing it to flow within the splice or between the metal surfaces.
5. When the solder has flowed over the entire wire splice or metal surface, move Tip away.
6. After use, clean and tin Tip as explained in step 3.
7. To prevent accidents, turn off the tool and unplug it after use. Let cool, then store the tool indoors out of children's reach.

## Maintenance and Servicing



Procedures not specifically explained in this manual must be performed only by a qualified technician.

### **WARNING**

**TO PREVENT SERIOUS INJURY FROM ACCIDENTAL OPERATION:**

Make sure that the Trigger is in the off-position, unplug the tool from its electrical outlet, and allow it to cool completely before performing any procedure in this section.

**TO PREVENT SERIOUS INJURY FROM TOOL FAILURE:**

Do not use damaged equipment. If abnormal noise or vibration occurs, have the problem corrected before further use.

## Inspection, Maintenance, and Cleaning

- BEFORE EACH USE**, inspect the general condition of the tool. Check for:
  - loose hardware
  - misalignment or binding of moving parts
  - damaged cord/electrical wiring
  - cracked or broken parts
  - any other condition that may affect its safe operation.
- WARNING! TO PREVENT SERIOUS INJURY:** If the supply cord of this power tool is damaged, it must be replaced only by a qualified service technician.

## Change Tip

**Note:** Replace the Soldering Tip if it cracks or becomes eroded.

1. Let Soldering Iron cool.
2. Remove Nut, Sleeve and Tip.
3. Push Tip into Sleeve, place Sleeve over heating element, then secure in place with Nut.
4. Calibrate unit according to Soldering Iron Tip Thermometer's instructions (sold separately).

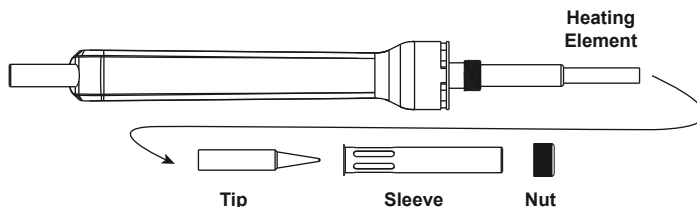



## PLEASE READ THE FOLLOWING CAREFULLY

---

THE MANUFACTURER AND/OR DISTRIBUTOR HAS PROVIDED THE PARTS LIST AND ASSEMBLY DIAGRAM IN THIS MANUAL AS A REFERENCE TOOL ONLY. NEITHER THE MANUFACTURER OR DISTRIBUTOR MAKES ANY REPRESENTATION OR WARRANTY OF ANY KIND TO THE BUYER THAT HE OR SHE IS QUALIFIED TO MAKE ANY REPAIRS TO THE PRODUCT, OR THAT HE OR SHE IS QUALIFIED TO REPLACE ANY PARTS OF THE PRODUCT. IN FACT, THE MANUFACTURER AND/OR DISTRIBUTOR EXPRESSLY STATES THAT ALL REPAIRS AND PARTS REPLACEMENTS SHOULD BE UNDERTAKEN BY CERTIFIED AND LICENSED TECHNICIANS, AND NOT BY THE BUYER. THE BUYER ASSUMES ALL RISK AND LIABILITY ARISING OUT OF HIS OR HER REPAIRS TO THE ORIGINAL PRODUCT OR REPLACEMENT PARTS THERETO, OR ARISING OUT OF HIS OR HER INSTALLATION OF REPLACEMENT PARTS THERETO.

SAFETY

SETUP

OPERATION

MAINTENANCE

## Parts List and Diagram

### Parts List

Part	Description	Qty
1	Iron Socket	1
2	Front Panel	1
3	PCBA	1
4	Temperature Knob	1
5	Transformer	1
6	Screw PT4x48	4
7	Top Housing	1
8	Power Cord	4
9	Power Switch	1
10	Power Cord Pressing Board	1
11	Bottom Housing	1
12	Screw PT4x12	4
13	Iron Plug	1
14	Strain Relief	1
15	Iron Handle	1

Part	Description	Qty
16	Iron Handle Sleeve	1
17	Heating Element Board	1
18	PCB	1
19	Heating Element	1
20	Ground Spring	1
21	Connector	1
22	Nut	1
23	Stainless Steel Sleeve	1
24	Tip	3
25	Sponge Holder	1
26	Sponge	1
27	Iron Holder	1
28	Stand Base-Plate	1
29	Stand Inner Case	1
30	Screw PT3.5x8	2

SAFETY

SETUP

OPERATION

MAINTENANCE

Record Product's Serial Number Here: \_\_\_\_\_

**Note:** If product has no serial number, record month and year of purchase instead.

**Note:** Some parts are listed and shown for illustration purposes only, and are not available individually as replacement parts. Specify UPC 792363573641 when ordering parts.

# Assembly Diagram

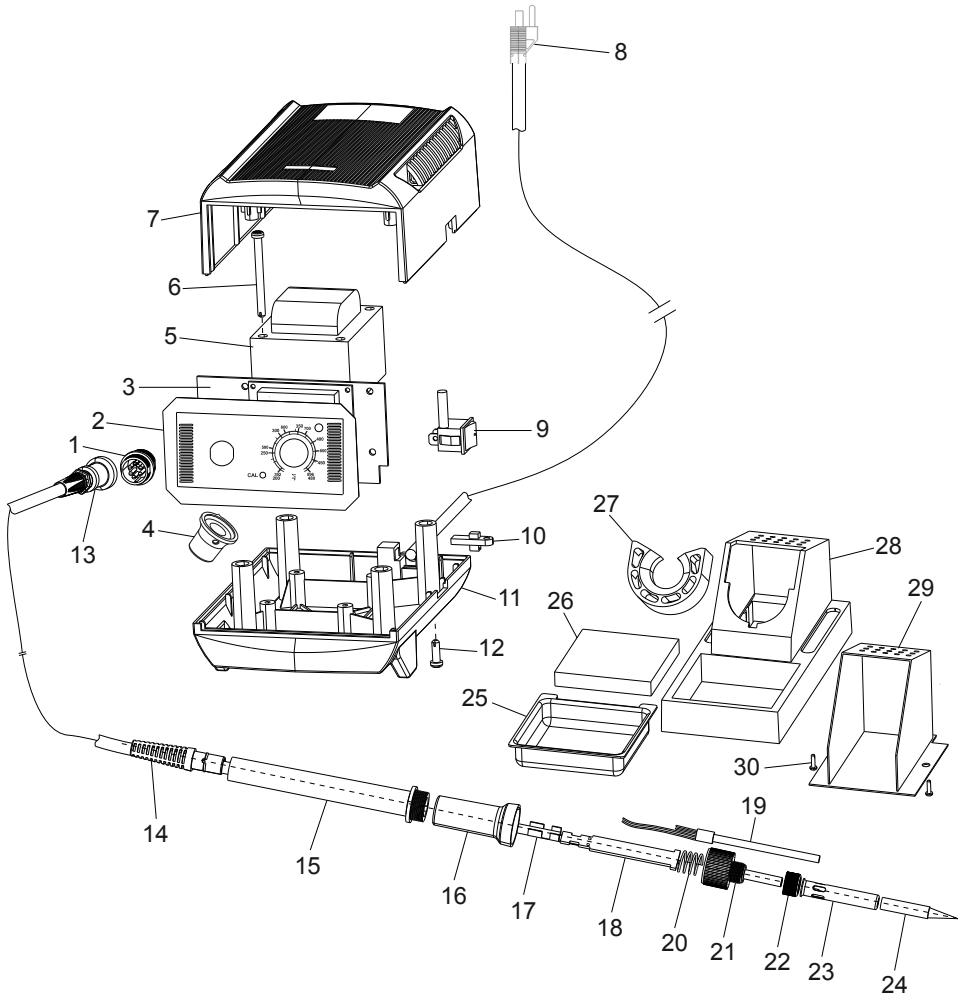

SAFETY

SETUP

OPERATION

MAINTENANCE

## Limited 90 Day Warranty

Harbor Freight Tools Co. makes every effort to assure that its products meet high quality and durability standards, and warrants to the original purchaser that this product is free from defects in materials and workmanship for the period of 90 days from the date of purchase. This warranty does not apply to damage due directly or indirectly, to misuse, abuse, negligence or accidents, repairs or alterations outside our facilities, criminal activity, improper installation, normal wear and tear, or to lack of maintenance. We shall in no event be liable for death, injuries to persons or property, or for incidental, contingent, special or consequential damages arising from the use of our product. Some states do not allow the exclusion or limitation of incidental or consequential damages, so the above limitation of exclusion may not apply to you. THIS WARRANTY IS EXPRESSLY IN LIEU OF ALL OTHER WARRANTIES, EXPRESS OR IMPLIED, INCLUDING THE WARRANTIES OF MERCHANTABILITY AND FITNESS.

To take advantage of this warranty, the product or part must be returned to us with transportation charges prepaid. Proof of purchase date and an explanation of the complaint must accompany the merchandise. If our inspection verifies the defect, we will either repair or replace the product at our election or we may elect to refund the purchase price if we cannot readily and quickly provide you with a replacement. We will return repaired products at our expense, but if we determine there is no defect, or that the defect resulted from causes not within the scope of our warranty, then you must bear the cost of returning the product.

This warranty gives you specific legal rights and you may also have other rights which vary from state to state.

The logo for Schneider, featuring the word "Schneider" in a stylized, cursive font with a horizontal line underneath it.