

Owner's Manual & Safety Instructions

Save This Manual Keep this manual for the safety warnings and precautions, assembly, operating, inspection, maintenance and cleaning procedures. Write the product's serial number in the back of the manual (or month and year of purchase if product has no number). Keep this manual and the receipt in a safe and dry place for future reference.

22f

PREDATOR®

INVERTER GENERATOR PARALLEL KIT

**7500 MAX STARTING WATTS
6000 MAX RUNNING WATTS**



⚠ DANGER

Using a generator indoors
CAN KILL YOU IN MINUTES.

Generator exhaust contains
carbon monoxide. This is a poison
you cannot see or smell.

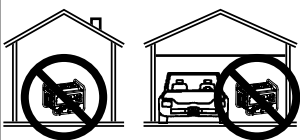

NEVER use inside
a home or garage,
EVEN IF doors and
windows are open.

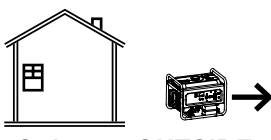

Only use **OUTSIDE**
and far away from
windows, doors,
and vents.

58374

Visit our website at: <http://www.harborfreight.com>
Email our technical support at: productsupport@harborfreight.com

When unpacking, make sure that the product is intact and undamaged. If any parts are missing or broken, please call 1-888-866-5797 as soon as possible.

⚠ WARNING

**Read this material before using this product.
Failure to do so can result in serious injury.
SAVE THIS MANUAL.**

Copyright© 2021 by Harbor Freight Tools®. All rights reserved.
No portion of this manual or any artwork contained herein may be reproduced in any shape or form without the express written consent of Harbor Freight Tools. Diagrams within this manual may not be drawn proportionally. Due to continuing improvements, actual product may differ slightly from the product described herein. Tools required for assembly and service may not be included.

Specifications





Output	120VAC / 60Hz / 50A 6000 Max Running Watts 7500 Max Starting Watts
Outlets	NEMA L5-30R, 30A NEMA 14-50R, 50A
Circuit Breakers	30A and 50A

Note:



1. Actual Running and Starting Watts will depend upon connected generators.
2. 14-50R receptacle is wired for 120V only. 240V loads will not work on this Parallel Kit.



PREDATOR®

WARNING SYMBOLS AND DEFINITIONS

	This is the safety alert symbol. It is used to alert you to potential personal injury hazards. Obey all safety messages that follow this symbol to avoid possible injury or death.
	Indicates a hazardous situation which, if not avoided, will result in death or serious injury.
	Indicates a hazardous situation which, if not avoided, could result in death or serious injury.
	Indicates a hazardous situation which, if not avoided, could result in minor or moderate injury.
	Addresses practices not related to personal injury.

Symbol Definitions

Symbol	Property or Statement
RPM	Revolutions Per Minute
HP	Horsepower
	WARNING marking concerning Risk of Eye Injury. Wear ANSI-approved safety goggles with side shields.
	Read the manual before set-up and/or use.
	WARNING marking concerning Risk of Hearing Loss. Wear hearing protection.

Symbol	Property or Statement
	WARNING marking concerning Risk of Respiratory Injury. Operate engine OUTSIDE and far away from windows, doors, and vents.
	WARNING marking concerning Risk of Fire while handling fuel. Do not smoke while handling fuel.
	WARNING marking concerning Risk of Fire. Do not refuel while operating. Keep flammable objects away from engine.

IMPORTANT SAFETY INSTRUCTIONS



WARNING! Read all instructions.

Failure to follow all instructions listed below may result in fire, serious injury and/or DEATH FROM ELECTRIC SHOCK.

The warnings and precautions discussed in this manual cannot cover all possible conditions and situations that may occur. It must be understood by the operator that common sense and caution are factors which cannot be built into this product, but must be supplied by the operator.

SAVE THESE INSTRUCTIONS

Set Up Precautions

1. Set up and use only on a flat, level, dry, well-ventilated surface.
2. All connections and conduits from the Generators to the load must only be installed by trained and licensed electricians, and in compliance with all relevant local, state, and federal electrical codes and standards, and other regulations where applicable.
3. Wear ANSI-approved safety goggles during set up.
4. Inspect thoroughly before each use. Do not use if damaged.
5. Do not plug more than the specified number of watts into this cord.
6. Do not run Parallel Kit through doorways, holes in ceilings, walls or floors.
7. Use two of the same model generator. Do not use two different generator models.
8. Turn generators off before connecting the Parallel Kit.
9. Fully insert cable plugs into outlets.
10. Do not remove, bend or modify any metal prongs or pins of the Parallel Kit.
11. Do not use excessive force to make connections.
12. Keep away from water.
13. Keep Parallel Kit dry and away from wet ground and mud.
14. Do not drive, drag or place objects over Parallel Kit Cords.
15. Do not walk on Parallel Kit Cords.
16. Connect Parallel Kit ground wires to ground stud on generators.

Operating Precautions

⚠️WARNING

TO PREVENT SERIOUS INJURY, DEATH, AND GENERATOR AND/OR EQUIPMENT DAMAGE FROM ELECTRIC SHOCK AND FIRE:

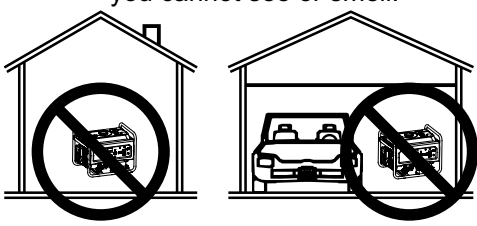
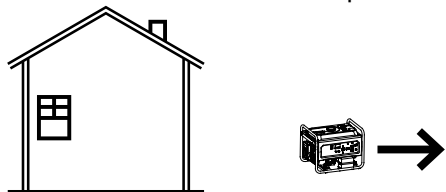
1.  **CARBON MONOXIDE HAZARD**
Using a generator indoors CAN KILL YOU IN MINUTES.
Generator exhaust contains carbon monoxide. This is a poison you cannot see or smell.

NEVER use inside a home or garage, EVEN IF doors and windows are open.

2. Never use generators indoors, including in garages, basements, crawl spaces and sheds. Opening doors and windows or using fans will NOT prevent carbon monoxide build up in the home.
3. When using generators, keep them outdoors and far away from open doors, windows, and vents to avoid toxic levels of carbon monoxide from building up indoors.
4. If you start to feel sick, dizzy, or weak while using generators, get to fresh air right away. The carbon monoxide from generators can quickly lead to full incapacitation and death.
5. Keep children and pets away from the Parallel Kit, especially while it is operating.
6. Do not exceed the maximum power rating of the generators. Make sure that the total electrical rating of the all of the tools or appliances plugged into the generators at the same time does not exceed that of the generator. Check that the startup surge will not be beyond the limit of the generators.

Only use OUTSIDE and far away from windows, doors, and vents.

Operating Precautions (cont.)

SAFETY

SETUP

OPERATION

MAINTENANCE

7. Avoid substantially overloading which will trip the circuit breaker. Slightly overloading the generators may not trip the circuit breaker, but will lead to premature generator failure.
8. Do not attempt to connect or disconnect load connections while standing in water, or on wet or soggy ground.
9. Do not touch electrically energized parts of the generators and interconnecting cables or conductors with any part of the body, or with any non-insulated conductive object.
10. Insulate all connections and disconnected wires.
11. Guard against electric shock. Prevent body contact with grounded surfaces such as pipes, radiators, ranges, and refrigerators.
12. Only connect two identical Inverter Generators together using the Parallel Kit.
13. Connect Parallel Kit only to terminals marked "Parallel Outlets" on the front of the generator.
14. Do not remove or connect Parallel Kit while generators are running.
15. Do not attach a Parallel Kit to only one generator.
16. Do not attach a heavy load to any other outlet on a Generator that has a Parallel Kit attached.
17. Wear ANSI-approved safety glasses during use.
18. People with pacemakers should consult their physician(s) before use. Electromagnetic fields in close proximity to a heart pacemaker could cause pacemaker interference or pacemaker failure. Caution is necessary when near the engine's magneto or recoil starter.
19. Use only accessories that are recommended by Harbor Freight Tools for your model. Accessories that may be suitable for one piece of equipment may become hazardous when used on another piece of equipment.
20. Stay alert, watch what you are doing and use common sense when operating this parallel kit. Do not use while tired or under the influence of drugs, alcohol or medication.
21. Dress properly. Do not wear loose clothing or jewelry. Keep hair, clothing and gloves away from moving parts. Loose clothes, jewelry or long hair can be caught in moving parts.
22. Use the equipment, accessories, etc., in accordance with these instructions and in the manner intended for the particular type of equipment, taking into account the working conditions and the work to be performed. Use of the equipment for operations different from those intended could result in a hazardous situation.
23. Before use, check for misalignment or binding of moving parts, breakage of parts, and any other condition that may affect the equipment's operation. **If damaged, have the equipment serviced before using.** Many accidents are caused by poorly maintained equipment.
24. Use the correct equipment for the application. Do not modify the equipment and do not use the equipment for a purpose for which it is not intended.
25. Extension Cord - Make sure your extension cord is in good condition. When using an extension cord, be sure to use one heavy enough to carry the current your product will draw. An undersized extension cord will cause a drop in line voltage resulting in loss of power and overheating.

The table below shows the correct cord size to use depending on cord length and nameplate ampere rating. If in doubt, use the next heavier gauge. The smaller the gauge number, the heavier the cord.

RECOMMENDED MINIMUM WIRE GAUGE FOR EXTENSION CORDS				
CURRENT (AMPS)	Load @ 120V (WATTS)	0 ~ 50 ft	50 ~ 75 ft	75 ~ 100 ft
2	240	18 AWG		
4	480	18 AWG		16 AWG
6	720	18 AWG	16 AWG	14 AWG
8	960	16 AWG		12 AWG
10	1200	16 AWG	14 AWG	12 AWG
15	1800	14 AWG	12 AWG	10 AWG
20	2400	12 AWG	10 AWG	
25	3000	12 AWG	10 AWG	8 AWG
30	3600	10 AWG	8 AWG	
35	4200	8 AWG	6 AWG	
40	4800	6 AWG		

Service Precautions

1. Before service, maintenance, or cleaning, unplug the Parallel Kit from both generators.
2. Keep all electrical equipment clean and dry. Replace any wiring where the insulation is cracked, cut, abraded, or otherwise degraded. Replace terminals that are worn, discolored, or corroded. Keep terminals clean and tight.
3. Do not alter or adjust any part of the equipment or its engine that is sealed by the manufacturer or distributor. Only a qualified service technician may adjust parts that may increase or decrease governed engine speed.
4. Wear ANSI-approved safety goggles during service.
5. Maintain labels and nameplates on the equipment. These carry important information. If unreadable or missing, contact Harbor Freight Tools for a replacement.
6. Have the equipment serviced by a qualified repair person using only identical replacement parts. This will ensure that the safety of the equipment is maintained. Do not attempt any service or maintenance procedures not explained in this manual or any procedures that you are uncertain about your ability to perform safely or correctly.
7. Store equipment out of the reach of children.



SAVE THESE INSTRUCTIONS.

Set Up



Read the **ENTIRE IMPORTANT SAFETY INFORMATION** section at the beginning of this manual including all text under subheadings therein before set up or use of this product.

1. Inspect the Parallel Kit and generators for damaged, loose, and missing parts before set up and starting. If any problems are found, do not use equipment until fixed properly.
2. Add fuel and oil to the generators according to the instructions in the generator manual.
3. Set up the Parallel Kit either on the ground or clipped to one of the two generators.
4. Connect the Red Connectors to the red parallel outlets on both generators.
5. Connect the Black Connectors to the black parallel outlets on both generators.
6. Connect the Grounding Connectors (rings) to the Grounding Terminals on both generators. Tighten the grounding screw securely.
7. Make sure the 50A Circuit Breaker is set to ON.

Note: If both parallel outlets on the generator control panels are black, then the Parallel Kit leads can be connected without the need for color matching.

Note: The Parallel Kit is Neutral Floating. However, final status of neutral wire will be that of the connected generator.

Components and Controls

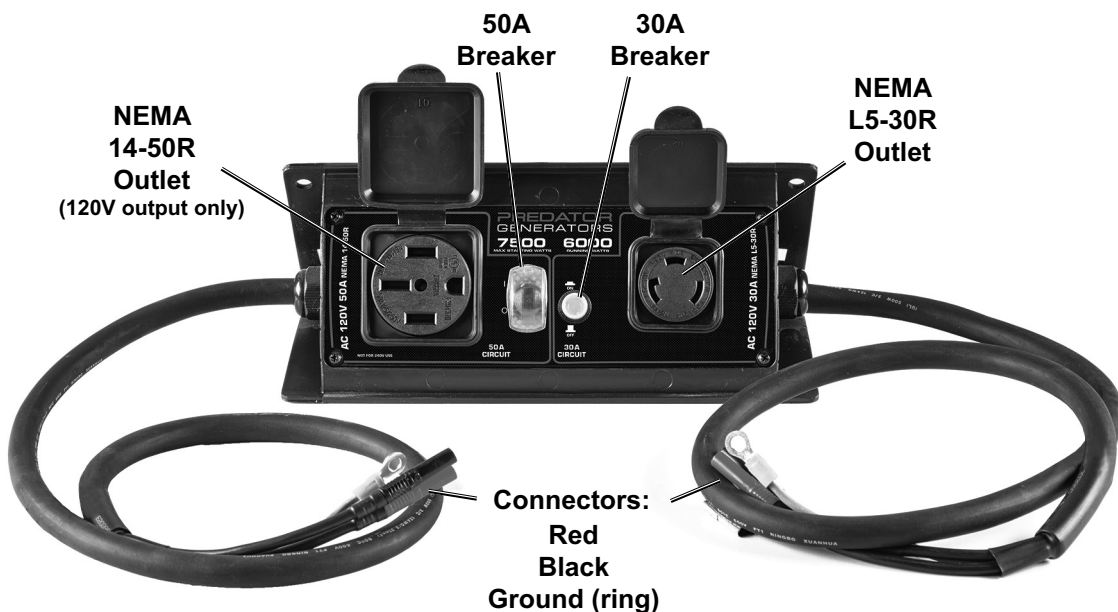

Operation



Read the **ENTIRE IMPORTANT SAFETY INFORMATION** section at the beginning of this manual including all text under subheadings therein before set up or use of this product.

Note: Position the generators as far from each other as possible to avoid hot air circulation and false triggering of carbon monoxide sensors (if applicable).

1. Turn on one generator, then the second.
2. Check that the Output lights of both generators are green.
3. Attach load to Parallel Kit.

Note: If high electrical loads are connected, keep the ESC Throttle OFF to reduce voltage changes.

4. If one generator shuts off during use, disconnect load until it can be restarted to avoid generator damage.

Note: Do not overload the generators. Substantial overloading will shut off the AC output and may shorten the service life of the generators.

Maintenance

⚠️ WARNING

TO PREVENT SERIOUS INJURY FROM EQUIPMENT FAILURE:

Do not use damaged equipment. If abnormal noise, vibration, or excess smoking occurs, have the problem corrected before further use.



Procedures not specifically explained in this manual must be performed only by a qualified technician.

1. **BEFORE EACH USE**, inspect the general condition of the kit. Check for:
 - loose hardware,
 - cracked or broken parts,
 - damaged electrical wiring or cable insulation, and
 - any other condition that may affect its safe operation.
2. After Use, wipe external surfaces of the kit with clean cloth.

Troubleshooting

Problem	Possible Causes	Probable Solutions
Parallel Kit doesn't have power	<ol style="list-style-type: none"> 1. Device not plugged in properly. 2. Circuit Breaker tripped. 3. Parallel Kit needs service. 	<ol style="list-style-type: none"> 1. Turn off generator and check outlet connections for correct positioning. Restart generator. 2. Turn off and unplug Parallel Kit, reset Circuit Breaker, plug in Parallel Kit and turn on. 3. Have Parallel Kit repaired.
Overload indicator flashes	Rated load capacity exceeded.	Lower the number of items plugged into the generator to stay within the rated capacity.



Follow all safety precautions whenever diagnosing or servicing the Parallel Kit.

Parts List and Diagram

Part	Description	Qty.
1	50A Parallel Kit	1
2	Breaker, 50A	1
3	Breaker, 30A	1
4	Outlet, Nema L5-30, 30A, 125V	1
5	Screw, PT4 x 13	4
6	Outlet, Nema 14-50R, 50A, 125V/250V	1
7	Cover, L5-30R	1
8	Cover, 14-50R	1

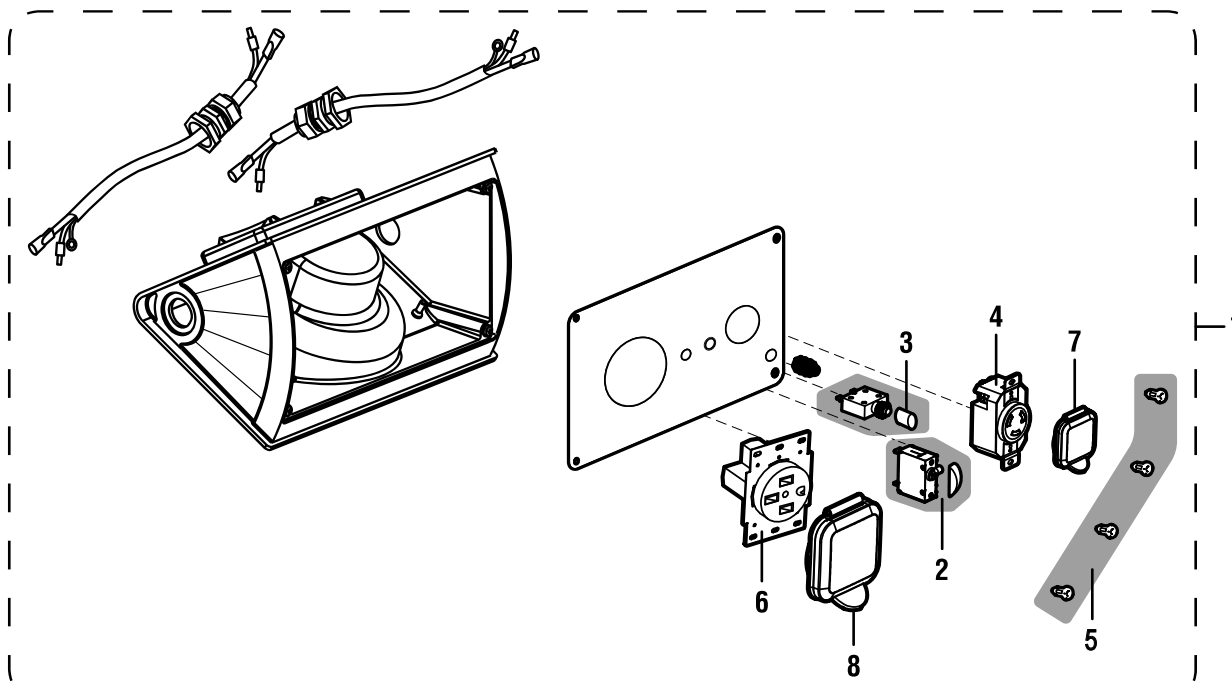

Record Product's Serial Number Here: _____

Note: If product has no serial number, record month and year of purchase instead.

Note: Some parts are listed and shown for illustration purposes only, and are not available individually as replacement parts. Specify UPC 193175438034 when ordering parts.

PLEASE READ THE FOLLOWING CAREFULLY

THE MANUFACTURER AND/OR DISTRIBUTOR HAS PROVIDED THE PARTS LIST AND ASSEMBLY DIAGRAM IN THIS MANUAL AS A REFERENCE TOOL ONLY. NEITHER THE MANUFACTURER OR DISTRIBUTOR MAKES ANY REPRESENTATION OR WARRANTY OF ANY KIND TO THE BUYER THAT HE OR SHE IS QUALIFIED TO MAKE ANY REPAIRS TO THE PRODUCT, OR THAT HE OR SHE IS QUALIFIED TO REPLACE ANY PARTS OF THE PRODUCT. IN FACT, THE MANUFACTURER AND/OR DISTRIBUTOR EXPRESSLY STATES THAT ALL REPAIRS AND PARTS REPLACEMENTS SHOULD BE UNDERTAKEN BY CERTIFIED AND LICENSED TECHNICIANS, AND NOT BY THE BUYER. THE BUYER ASSUMES ALL RISK AND LIABILITY ARISING OUT OF HIS OR HER REPAIRS TO THE ORIGINAL PRODUCT OR REPLACEMENT PARTS THERETO, OR ARISING OUT OF HIS OR HER INSTALLATION OF REPLACEMENT PARTS THERETO.

Limited 90 Day Warranty

Harbor Freight Tools Co. makes every effort to assure that its products meet high quality and durability standards, and warrants to the original purchaser that this product is free from defects in materials and workmanship for the period of 90 days from the date of purchase. This warranty does not apply to damage due directly or indirectly, to misuse, abuse, negligence or accidents, repairs or alterations outside our facilities, criminal activity, improper installation, normal wear and tear, or to lack of maintenance. We shall in no event be liable for death, injuries to persons or property, or for incidental, contingent, special or consequential damages arising from the use of our product. Some states do not allow the exclusion or limitation of incidental or consequential damages, so the above limitation of exclusion may not apply to you. THIS WARRANTY IS EXPRESSLY IN LIEU OF ALL OTHER WARRANTIES, EXPRESS OR IMPLIED, INCLUDING THE WARRANTIES OF MERCHANTABILITY AND FITNESS.

To take advantage of this warranty, the product or part must be returned to us with transportation charges prepaid. Proof of purchase date and an explanation of the complaint must accompany the merchandise. If our inspection verifies the defect, we will either repair or replace the product at our election or we may elect to refund the purchase price if we cannot readily and quickly provide you with a replacement. We will return repaired products at our expense, but if we determine there is no defect, or that the defect resulted from causes not within the scope of our warranty, then you must bear the cost of returning the product.

This warranty gives you specific legal rights and you may also have other rights which vary from state to state.

PREDATOR®

26677 Agoura Rd • Calabasas, CA 91302 • 1-888-866-5797