

# Owner's Manual & Safety Instructions

Save This Manual Keep this manual for the safety warnings and precautions, assembly, operating, inspection, maintenance and cleaning procedures. Write the product's serial number in the back of the manual near the assembly diagram (or month and year of purchase if product has no number). Keep this manual and the receipt in a safe and dry place for future reference.

21j

# Bauer™

## 21101C-B

### BRUSHLESS

# 20v

## HYPERMAX™ LITHIUM

For Best Results,  
Use 3.0 Amp Hour or Greater  
Battery (Sold Separately)



## BRUSHLESS OSCILLATING MULTI-TOOL

Visit our website at: <http://www.harborfreight.com>  
Email our technical support at: [productsupport@harborfreight.com](mailto:productsupport@harborfreight.com)

**58379**

When unpacking, make sure that the product is intact and undamaged. If any parts are missing or broken, please call 1-888-866-5797 as soon as possible.

Copyright© 2020 by Harbor Freight Tools®. All rights reserved.  
No portion of this manual or any artwork contained herein may be reproduced in any shape or form without the express written consent of Harbor Freight Tools. Diagrams within this manual may not be drawn proportionally. Due to continuing improvements, actual product may differ slightly from the product described herein. Tools required for assembly and service may not be included.

### **⚠WARNING**

Read this material before using this product.  
Failure to do so can result in serious injury.  
**SAVE THIS MANUAL.**

# Table of Contents

Safety .....	2	Maintenance .....	9
Specifications .....	7	Parts List and Diagram .....	11
Setup .....	7	Warranty .....	12
Operation .....	8		



SAFETY

SETUP

OPERATION

MAINTENANCE

## WARNING SYMBOLS AND DEFINITIONS

	This is the safety alert symbol. It is used to alert you to potential personal injury hazards. Obey all safety messages that follow this symbol to avoid possible injury or death.
	Indicates a hazardous situation which, if not avoided, will result in death or serious injury.
	Indicates a hazardous situation which, if not avoided, could result in death or serious injury.
	Indicates a hazardous situation which, if not avoided, could result in minor or moderate injury.
	Addresses practices not related to personal injury.

## IMPORTANT SAFETY INFORMATION

### General Power Tool Safety Warnings

#### WARNING

Read all safety warnings, instructions, illustrations and specifications provided with this power tool. Failure to follow all instructions listed below may result in electric shock, fire and/or serious injury.

Save all warnings and instructions for future reference.

The term "power tool" in the warnings refers to your mains-operated (corded) power tool or battery-operated (cordless) power tool.

1. **Work area safety**
  - a. **Keep work area clean and well lit.**  
*Cluttered or dark areas invite accidents.*
  - b. **Do not operate power tools in explosive atmospheres, such as in the presence of flammable liquids, gases or dust.** *Power tools create sparks which may ignite the dust or fumes.*
  - c. **Keep children and bystanders away while operating a power tool.** *Distractions can cause you to lose control.*

## 2. Electrical safety

- a. **Power tool plugs must match the outlet. Never modify the plug in any way. Do not use any adapter plugs with earthed (grounded) power tools.** *Unmodified plugs and matching outlets will reduce risk of electric shock.*
- b. **Avoid body contact with earthed or grounded surfaces, such as pipes, radiators, ranges and refrigerators.** *There is an increased risk of electric shock if your body is earthed or grounded.*
- c. **Do not expose power tools to rain or wet conditions.** *Water entering a power tool will increase the risk of electric shock.*
- d. **Do not abuse the cord. Never use the cord for carrying, pulling or unplugging the power tool. Keep cord away from heat, oil, sharp edges or moving parts.** *Damaged or entangled cords increase the risk of electric shock.*
- e. **When operating a power tool outdoors, use an extension cord suitable for outdoor use.** *Use of a cord suitable for outdoor use reduces the risk of electric shock.*
- f. **If operating a power tool in a damp location is unavoidable, use a ground fault circuit interrupter (GFCI) protected supply.** *Use of a GFCI reduces the risk of electric shock.*

## 3. Personal safety

- a. **Stay alert, watch what you are doing and use common sense when operating a power tool. Do not use a power tool while you are tired or under the influence of drugs, alcohol or medication.** *A moment of inattention while operating power tools may result in serious personal injury.*
- b. **Use personal protective equipment. Always wear eye protection.** *Protective equipment such as dust mask, non-skid safety shoes, hard hat, or hearing protection used for appropriate conditions will reduce personal injuries.*
- c. **Prevent unintentional starting. Ensure the switch is in the off-position before connecting to power source and/or battery pack, picking up or carrying the tool.** *Carrying power tools with your finger on the switch or energizing power tools that have the switch on invites accidents.*
- d. **Remove any adjusting key or wrench before turning the power tool on.** *A wrench or a key left attached to a rotating part of the power tool may result in personal injury.*
- e. **Do not overreach. Keep proper footing and balance at all times.** *This enables better control of the power tool in unexpected situations.*

- f. **Dress properly. Do not wear loose clothing or jewelry. Keep your hair, clothing and gloves away from moving parts.** *Loose clothes, jewelry or long hair can be caught in moving parts.*

- g. **If devices are provided for the connection of dust extraction and collection facilities, ensure these are connected and properly used.** *Use of dust collection can reduce dust-related hazards.*

- h. **Do not let familiarity gained from frequent use of tools allow you to become complacent and ignore tool safety principles.** *A careless action can cause severe injury within a fraction of a second.*

- i. Only use safety equipment that has been approved by an appropriate standards agency. Unapproved safety equipment may not provide adequate protection. Eye protection must be ANSI-approved and breathing protection must be NIOSH-approved for the specific hazards in the work area.

- j. Do not lay the tool down until it has come to a complete stop. Moving parts can grab the surface and pull the tool out of your control.

- k. When using a handheld power tool, maintain a firm grip.

- l. Do not leave the tool unattended when the Battery Pack is connected. Turn off the tool, and remove the Battery Pack before leaving.

- m. This product is not a toy. Keep it out of reach of children.

- n. People with pacemakers should consult their physician(s) before use. Electromagnetic fields in close proximity to heart pacemaker could cause pacemaker interference or pacemaker failure.

- o. The warnings, precautions, and instructions discussed in this instruction manual cannot cover all possible conditions and situations that may occur. It must be understood by the operator that common sense and caution are factors which cannot be built into this product, but must be supplied by the operator.

## 4. Power tool use and care

- a. **Do not force the power tool. Use the correct power tool for your application.** *The correct power tool will do the job better and safer at the rate for which it was designed.*

- b. **Do not use the power tool if the switch does not turn it on and off.** *Any power tool that cannot be controlled with the switch is dangerous and must be repaired.*

- c. **Disconnect the plug from the power source and/or remove the battery pack, if detachable, from the power tool before making any adjustments, changing accessories, or storing power tools.** *Such preventive safety measures reduce the risk of starting the power tool accidentally.*
  - d. **Store idle power tools out of the reach of children and do not allow persons unfamiliar with the power tool or these instructions to operate the power tool.** *Power tools are dangerous in the hands of untrained users.*
  - e. **Maintain power tools and accessories. Check for misalignment or binding of moving parts, breakage of parts and any other condition that may affect the power tool's operation. If damaged, have the power tool repaired before use.** *Many accidents are caused by poorly maintained power tools.*
  - f. **Keep cutting tools sharp and clean.** *Properly maintained cutting tools with sharp cutting edges are less likely to bind and are easier to control.*
  - g. **Use the power tool, accessories and tool bits etc. in accordance with these instructions, taking into account the working conditions and the work to be performed.** *Use of the power tool for operations different from those intended could result in a hazardous situation.*
  - h. **Keep handles and grasping surfaces dry, clean and free from oil and grease.** *Slippery handles and grasping surfaces do not allow for safe handling and control of the tool in unexpected situations.*
5. **Service**
    - a. **Have your power tool serviced by a qualified repair person using only identical replacement parts.** *This will ensure that the safety of the power tool is maintained.*
    - b. Maintain labels and nameplates on the tool. These carry important safety information. If unreadable or missing, contact Harbor Freight Tools for a replacement.
  6. **Safety instructions for reciprocating saws**
    - a. **Hold the power tool by insulated gripping surfaces, when performing an operation where the cutting accessory may contact hidden wiring or its own cord.** *Cutting accessory contacting a "live" wire may make exposed metal parts of the power tool "live" and could give the operator an electric shock.*
    - b. **Use clamps or another practical way to secure and support the workpiece to a stable platform.** *Holding the workpiece by hand or against your body leaves it unstable and may lead to loss of control.*
  7. **Belt sander and drum sander safety warnings**
    - a. **Hold the power tool by insulated gripping surfaces, because the sanding surface may contact its own cord.** *Cutting a "live" wire may make exposed metal parts of the power tool "live" and could give the operator an electric shock.*
  8. **Battery tool use and care**
    - a. **Prevent unintentional starting.** *Ensure the switch is in the off-position before connecting to battery pack, picking up or carrying the power tool. Carrying the power tool with your finger on the switch or energizing power tool that have the switch on invites accidents.*
    - b. **Disconnect the battery pack from the power tool before making any adjustments, changing accessories, or storing power tool.** *Such preventive safety measures reduce the risk of starting the power tool accidentally.*
    - c. **Recharge only with the charger specified by the manufacturer.** *A charger that is suitable for one type of battery pack may create a risk of fire when used with another battery pack.*
    - d. **Use power tools only with specifically designated battery packs.** *Use of any other battery packs may create a risk of injury and fire.*
    - e. **When battery pack is not in use, keep it away from other metal objects, like paper clips, coins, keys, nails, screws or other small metal objects, that can make a connection from one terminal to another.** *Shorting the battery terminals together may cause burns or a fire.*
    - f. **Under abusive conditions, liquid may be ejected from the battery; avoid contact.** *If contact accidentally occurs, flush with water. If liquid contacts eyes, additionally seek medical help. Liquid ejected from the battery may cause irritation or burns.*
    - g. **Do not use a battery pack or power tool that is damaged or modified.** *Damaged or modified batteries may exhibit unpredictable behavior resulting in fire, explosion or risk of injury.*
    - h. **Do not expose a battery pack or power tool to fire or excessive temperature.** *Exposure to fire or temperature above 265°F may cause explosion.*
    - i. **Follow all charging instructions and do not charge the battery pack or power tool outside of the temperature range specified in the instructions.** *Charging improperly or at temperatures outside of the specified range may damage the battery and increase the risk of fire.*
    - j. **Have servicing performed by a qualified repair person using only identical replacement parts.** *This will ensure that the safety of the product is maintained.*

k. **Do not modify or attempt to repair the power tool or the battery pack except as indicated in the instructions for use and care.**

- l.  The battery Charger gets hot during use. The Charger's heat can build up to unsafe levels and create a fire hazard if it does not receive adequate ventilation, due to an electrical fault, or if it is used in a hot environment. Do not place the Charger on a flammable surface. Do not obstruct any vents on the Charger. **Especially avoid placing the Charger on carpets and rugs; they are not only flammable, but they also obstruct vents under the Charger.** Place the Charger on a stable, solid, nonflammable surface (such as a stable metal workbench or concrete floor) at least 1 foot away from all flammable objects, such as drapes or walls. Keep a fire extinguisher and a smoke detector in the area. Frequently monitor the Charger and Battery Pack while charging.

#### 9. Lithium Battery Safety Warnings



**LITHIUM BATTERIES STORE A LARGE AMOUNT OF ENERGY AND WILL VENT FIRE OR EXPLODE IF MISTREATED:**

- Keep Battery Pack dry.
- DO NOT DO ANY OF THE FOLLOWING TO THE BATTERY PACK:**
  - Open,
  - Drop,
  - Short-circuit,
  - Puncture,
  - Incinerate, or
  - Expose to temperatures greater than 265°F.

- Charge Battery Pack only according to its Charger's instructions.
- Inspect Battery Pack before every use; do not use or charge if damaged.

#### 10. Vibration Safety

This tool vibrates during use. Repeated or long-term exposure to vibration may cause temporary or permanent physical injury, particularly to the hands, arms and shoulders. To reduce the risk of vibration-related injury:

- Anyone using vibrating tools regularly or for an extended period should first be examined by a doctor and then have regular medical check-ups to ensure medical problems are not being caused or worsened from use. Pregnant women or people who have impaired blood circulation to the hand, past hand injuries, nervous system disorders, diabetes, or Raynaud's Disease should not use this tool. If you feel any symptoms related to vibration (such as tingling, numbness, and white or blue fingers), seek medical advice as soon as possible.
- Do not smoke during use. Nicotine reduces the blood supply to the hands and fingers, increasing the risk of vibration-related injury.
- Wear suitable gloves to reduce the vibration effects on the user.
- Use tools with the lowest vibration when there is a choice.
- Include vibration-free periods each day of work.
- Grip tool as lightly as possible (while still keeping safe control of it). Let the tool do the work.
- To reduce vibration, maintain the tool as explained in this manual. If any abnormal vibration occurs, stop use immediately.

## Grounding

### **⚠ WARNING**



**TO PREVENT ELECTRIC SHOCK AND DEATH FROM INCORRECT GROUNDING:**

Check with a qualified electrician if you are in doubt as to whether the outlet is properly grounded. Do not modify the power cord plug provided with the charger. Do not use the charger if the power cord or plug is damaged. If damaged, have it repaired by a service facility before use. If the plug will not fit the outlet, have a proper outlet installed by a qualified electrician.

## Extension Cords

**Note:** Extension cords must not be used with this item's Charger.





# Symbology





SAFETY

SETUP

OPERATION

MAINTENANCE

	Double Insulated
	Volts
	Alternating Current
	Amperes
n <sub>0</sub> xxxx/min.	No Load Revolutions per Minute (RPM)
	WARNING marking concerning Risk of Eye Injury. Wear ANSI-approved safety goggles with side shields.

	Read the manual before set-up and/or use.
	WARNING marking concerning Risk of Fire. Do not cover Charger ventilation ducts. Charge on fireproof surface only.
	WARNING marking concerning Risk of Electric Shock. Properly connect Charger's power cord to appropriate outlet.
	WARNING marking concerning Risk of Explosion. Do not puncture, short, or open battery packs and do not charge damaged battery packs.

# **Bauer**<sup>TM</sup>

## Specifications

Battery Pack	Bauer 20V Li-Ion 64817, 64816, 57007 (sold separately)
Charger	Bauer 20V Li-Ion 57006, 63529 or 63947 (sold separately)
No Load Speed	$n_0$ : 8,000 - 20,000/min

## Setup - Before Use:



Read the **ENTIRE IMPORTANT SAFETY INFORMATION** section at the beginning of this manual including all text under subheadings therein before set up or use of this product.

**Note:** For additional information regarding the parts listed in the following pages, refer to *Parts List and Diagram* on page 11.

## Charging

Charge battery after unpacking and before using this tool. Follow instructions included with battery charger (sold separately).

## Functions

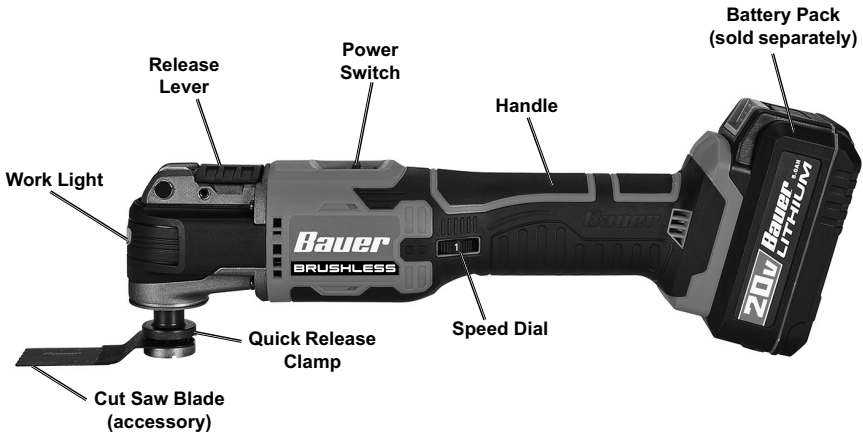

## Operating Instructions



Read the **ENTIRE IMPORTANT SAFETY INFORMATION** section at the beginning of this manual including all text under subheadings therein before set up or use of this product.

## Workpiece and Work Area Set Up

1. Workpiece selection:
  - a. Workpiece must be free of foreign objects.
  - b. Wear a NIOSH-approved respirator and have appropriate ventilation whenever sanding pressure treated lumber.
2. Designate a work area that is clean and well lit. The work area must not allow access by children or pets to prevent distraction and injury.
3. Secure loose workpieces using a vise or clamps (not included) to prevent movement while working.
4. There must not be objects, such as utility lines, nearby that will present a hazard while working. This is especially critical for plunge cuts.

## Tool Changing

### **WARNING**

**TO PREVENT SERIOUS INJURY FROM ACCIDENTAL OPERATION:**  
Make sure that the Trigger is in the off-position and remove its Battery Pack before performing any procedure in this section.

**Note:** Accessories sold separately.

1. To remove/install an accessory, flip the Release Lever forward to the open position. See below.

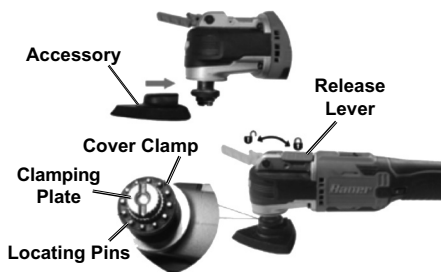

2. Install the desired accessory by inserting it into the Shaft and placing it onto the Locating Pins.

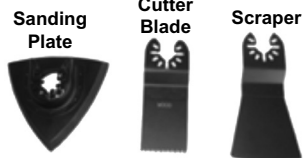

- Use the Sanding Plate for sanding wood, metal, small area and corners.
- Use the Cutter Blade to saw wood, plaster board, and soft plastics.
- Use the Scraper for scraping off old varnish, adhesives or removing dried glue.

3. Close the Release Lever to the locked position.

**Note:** The Cutter Blade and Spatula should only be used in the straight ahead position.

**WARNING! TO PREVENT SERIOUS INJURY:**  
Wear heavy duty work gloves when installing the Cutter Blade. Its teeth are very sharp. Do not touch during removal/installation.

**CAUTION!** When attaching the Cutter Blade and Spatula, orient the accessory so that the blade faces AWAY from the handle to avoid injury.

4. After securing, the attachment should not move on the Spindle. If it can move with the power off, reattach it, making sure that the holes on the attachment line up with the fitting pins on the Shaft.

**Note:** For sanding, first attach the hook and loop Sanding Pad to the tool, then align a piece of sand paper over the pad and press into place. Once a sand paper corner becomes worn, turn it 120° or replace the piece with a new one.

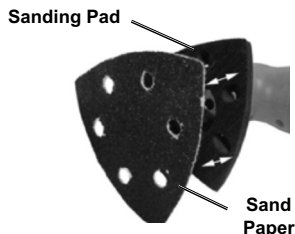



## Setting and Testing

---

1. Ensure accessory is correctly attached to tool.
2. Switch the Power Switch to the OFF position then insert a fully charged Battery Pack, making sure it clicks into place securely.
3. Switch the Power Switch to ON and run the tool for at least 30 seconds.
4. If abnormal noise/vibration occurs or the accessory slips, have the problem corrected before further use.

## General Instructions for Use

---

1. Make sure that the Power Switch is in the OFF position, then insert a fully charged Battery Pack making sure it clicks into place securely.
2. Hold the Tool with both hands and slide the Power Switch to the ON position. The Work Light will illuminate when the tool is switched on and turn off when the tool is switched off.
4. Do not allow contact between sand paper or Blade and workpiece until the tool is running at the intended speed.
5. Avoid contact with foreign objects such as metal screws and nails when sanding, scraping, or cutting.

**WARNING! TO PREVENT SERIOUS INJURY: Do not stare directly at the light beam. Never aim the beam at any person or an object other than the workpiece. Do not deliberately aim the beam at personnel and ensure that it is directed toward the eye of a person for longer than 0.25 seconds.**

3. Adjust the speed of the tool using the Speed Dial. There are six speed settings from 1 (slowest) to 6 (fastest). Determine the optimum speed by testing on a scrap piece of material.
6. Do not apply excessive pressure on the Tool. Allow the Tool to do the work.
7. When finished, slide the Power Switch to the OFF position. Allow the tool to stop completely before setting it down.
8. To prevent accidents, turn off the tool and remove the Battery Pack. Clean, then store the tool indoors out of children's reach.

**Notice:** When sawing, always set the Cutter Blade straight, at 90°, and guide it through the cut without tilting.

## Maintenance and Servicing Instructions



Procedures not specifically explained in this manual must be performed only by a qualified technician.



### **TO PREVENT SERIOUS INJURY FROM ACCIDENTAL OPERATION:**

Make sure that the Trigger is in the off-position and remove its Battery Pack before performing any procedure in this section.

### **TO PREVENT SERIOUS INJURY FROM TOOL FAILURE:**

Do not use damaged equipment. If abnormal noise or vibration occurs, have the problem corrected before further use.

## Cleaning, Maintenance, and Lubrication

- BEFORE EACH USE**, inspect the general condition of the tool. Check for:
  - leaking, swollen, or cracked battery pack,
  - loose hardware,
  - misalignment or binding of moving parts,
  - cracked or broken parts, and
  - any other condition that may affect its safe operation.
- AFTER USE**, wipe external surfaces of the tool with clean cloth.
- Disconnect battery pack and store tool in dry, indoor area out of reach of children and away from metal objects (i.e., paperclips, coins) to prevent shorting.

## Troubleshooting

Problem	Possible Causes	Likely Solutions
Tool will not start.	<ol style="list-style-type: none"> <li>Battery Pack not properly connected.</li> <li>Battery Pack not properly charged.</li> <li>Battery Pack burnt-out.</li> <li>Internal damage or wear. (Trigger, for example.)</li> </ol>	<ol style="list-style-type: none"> <li>Remove Battery Pack, make sure there are no obstructions, reinsert the Battery Pack according to its shape (it should only fit one way), and press firmly until the Battery Pack locks in place.</li> <li>Make sure Charger is connected and operating properly. Give enough time for Battery Pack to recharge properly.</li> <li>Dispose of old Battery Pack properly or recycle. Replace Battery Pack.</li> <li>Have technician service tool.</li> </ol>
Tool operates slowly.	<ol style="list-style-type: none"> <li>Forcing tool to work too fast.</li> <li>Battery Pack wearing out.</li> </ol>	<ol style="list-style-type: none"> <li>Allow tool to work at its own rate.</li> <li>Dispose of old Battery Pack properly or recycle. Replace Battery Pack.</li> </ol>
Performance decreases over time.	Blade dull or damaged.	Keep blades sharp. Replace as needed.
Excessive noise or rattling.	Internal damage or wear. (Bearings, for example.)	Have technician service tool.
Overheating.	<ol style="list-style-type: none"> <li>Forcing tool to work too fast.</li> <li>Blade dull or damaged.</li> <li>Blocked motor housing vents.</li> </ol>	<ol style="list-style-type: none"> <li>Allow tool to work at its own rate.</li> <li>Keep blades sharp. Replace as needed.</li> <li>Wear ANSI-approved safety goggles and NIOSH-approved dust mask/respirator while blowing dust out of motor using compressed air.</li> </ol>



Follow all safety precautions whenever diagnosing or servicing the tool. Disconnect Battery Pack and Charger power supply before service.

# PLEASE READ THE FOLLOWING CAREFULLY

THE MANUFACTURER AND/OR DISTRIBUTOR HAS PROVIDED THE PARTS LIST AND ASSEMBLY DIAGRAM IN THIS MANUAL AS A REFERENCE TOOL ONLY. NEITHER THE MANUFACTURER OR DISTRIBUTOR MAKES ANY REPRESENTATION OR WARRANTY OF ANY KIND TO THE BUYER THAT HE OR SHE IS QUALIFIED TO MAKE ANY REPAIRS TO THE PRODUCT, OR THAT HE OR SHE IS QUALIFIED TO REPLACE ANY PARTS OF THE PRODUCT. IN FACT, THE MANUFACTURER AND/OR DISTRIBUTOR EXPRESSLY STATES THAT ALL REPAIRS AND PARTS REPLACEMENTS SHOULD BE UNDERTAKEN BY CERTIFIED AND LICENSED TECHNICIANS, AND NOT BY THE BUYER. THE BUYER ASSUMES ALL RISK AND LIABILITY ARISING OUT OF HIS OR HER REPAIRS TO THE ORIGINAL PRODUCT OR REPLACEMENT PARTS THERETO, OR ARISING OUT OF HIS OR HER INSTALLATION OF REPLACEMENT PARTS THERETO.

## Parts List and Diagram

Part	Description	Qty
1	Self Tapping Screw	4
2	Spring Washer	4
3	Cover	1
4	Work Light	1
5	Screw	1
6	Housing Assembly	1
7	Motor Assembly	1
8	Screw	4

Part	Description	Qty
9	PCB Assembly	1
10	Fender Apron Shield	1
11	Power Switch	1
12	Left and Right Housing	1
13	Self Tapping Screw	11
14	Spring Piece	2
15	Rubber Gasket	4

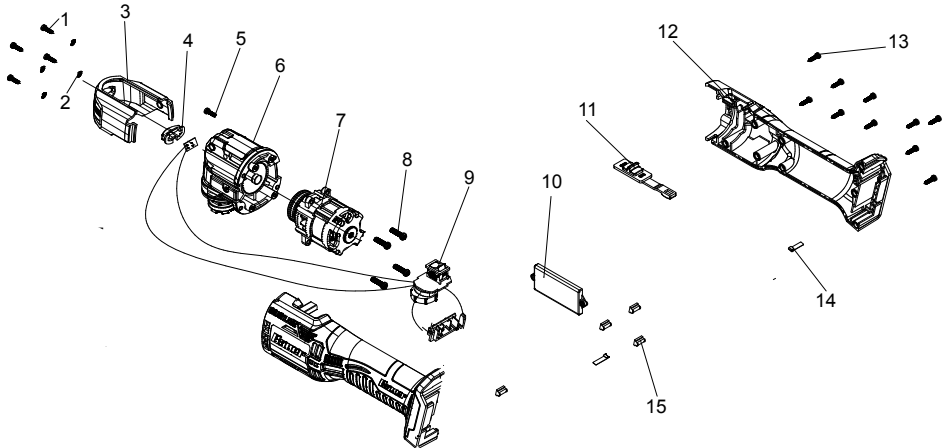

SAFETY

SETUP

OPERATION

MAINTENANCE

## Limited 90 Day Warranty

Harbor Freight Tools Co. makes every effort to assure that its products meet high quality and durability standards, and warrants to the original purchaser that this product is free from defects in materials and workmanship for the period of 90 days from the date of purchase. This warranty does not apply to damage due directly or indirectly, to misuse, abuse, negligence or accidents, repairs or alterations outside our facilities, criminal activity, improper installation, normal wear and tear, or to lack of maintenance. We shall in no event be liable for death, injuries to persons or property, or for incidental, contingent, special or consequential damages arising from the use of our product. Some states do not allow the exclusion or limitation of incidental or consequential damages, so the above limitation of exclusion may not apply to you. THIS WARRANTY IS EXPRESSLY IN LIEU OF ALL OTHER WARRANTIES, EXPRESS OR IMPLIED, INCLUDING THE WARRANTIES OF MERCHANTABILITY AND FITNESS.

To take advantage of this warranty, the product or part must be returned to us with transportation charges prepaid. Proof of purchase date and an explanation of the complaint must accompany the merchandise. If our inspection verifies the defect, we will either repair or replace the product at our election or we may elect to refund the purchase price if we cannot readily and quickly provide you with a replacement. We will return repaired products at our expense, but if we determine there is no defect, or that the defect resulted from causes not within the scope of our warranty, then you must bear the cost of returning the product.

This warranty gives you specific legal rights and you may also have other rights which vary from state to state.

**Record Product's Serial Number Here:** \_\_\_\_\_

**Note:** If product has no serial number, record month and year of purchase instead.

**Note:** Some parts are listed and shown for illustration purposes only, and are not available individually as replacement parts. Specify UPC 193175438089 when ordering parts.

# ***Bauer***<sup>™</sup>

26677 Agoura Road • Calabasas, CA 91302 • 1-888-866-5797