

# Owner's Manual & Safety Instructions

Save This Manual Keep this manual for the safety warnings and precautions, assembly, operating, inspection, maintenance and cleaning procedures. Write the product's serial number in the back of the manual near the assembly diagram (or month and year of purchase if product has no number). Keep this manual and the receipt in a safe and dry place for future reference.

22d

**MADDOX**<sup>®</sup>  
SUPERIOR AUTOMOTIVE TOOLS

MBD1

## Deluxe Paintless Dent Repair Kit



Visit our website at: <http://www.harborfreight.com>  
Email our technical support at: [productsupport@harborfreight.com](mailto:productsupport@harborfreight.com)

58450

When unpacking, make sure that the product is intact and undamaged. If any parts are missing or broken, please call 1-888-866-5797 as soon as possible.

Copyright© 2021 by Harbor Freight Tools®. All rights reserved.

No portion of this manual or any artwork contained herein may be reproduced in any shape or form without the express written consent of Harbor Freight Tools. Diagrams within this manual may not be drawn proportionally. Due to continuing improvements, actual product may differ slightly from the product described herein. Tools required for assembly and service may not be included.

### **⚠WARNING**

Read this material before using this product.  
Failure to do so can result in serious injury.  
**SAVE THIS MANUAL.**

# Specifications





Glue Gun	120VAC / 60Hz / 40W
----------	---------------------

## Important Safety Information

### **⚠️ WARNING** TO PREVENT SERIOUS INJURY:

- 1. TO PREVENT ELECTRIC SHOCK: Keep glue gun dry, do not use in rain.**
- 2. Avoid skin contact with tip and melted hot glue.**
- 3. Do not smoke, strike a match, or be near a spark when using or opening the Release Agent.**
- 4. Work in a well ventilated area.**
- 5. Wear ANSI-approved safety goggles and heavy-duty work gloves during use.**
- 6. This product is not a toy. Do not allow children to play with or near this tool.**
- 7. Use as intended only.**
- 8. Inspect before every use; do not use if parts are loose or damaged.**
- 9. Maintain product labels and nameplates. These carry important safety information. If unreadable or missing, contact Harbor Freight Tools for a replacement.**

### WARNING SYMBOLS AND DEFINITIONS

	This is the safety alert symbol. It is used to alert you to potential personal injury hazards. Obey all safety messages that follow this symbol to avoid possible injury or death.
	Indicates a hazardous situation which, if not avoided, will result in death or serious injury.
	Indicates a hazardous situation which, if not avoided, could result in death or serious injury.
	Indicates a hazardous situation which, if not avoided, could result in minor or moderate injury.
	Addresses practices not related to personal injury.

## Instructions

**Note:** This Kit will not repair ALL dents, regardless of size. **It will not work on aluminum surfaces.**

1. Insert Glue Stick into Glue Gun. Plug Glue Gun into grounded 120VAC outlet. Allow to warm up for ten to fifteen minutes before use.

**Note:** Do not use crafting glue sticks.

2. Using clean cloth (not included), clean dent area with Release Agent.
3. Choose Pull Tab the same size as dent.
4. Apply glue to Pull Tab then quickly place Pull Tab on center of dent and hold there for ten seconds.
5. Wait two to three minutes for glue to set before applying puller.

### Slide Hammer

---

1. Place Slide Hammer over end of Pull Tab. Slide it backward and forward until dent is raised.



2. Remove Slide Hammer.

3. Remove Pull Tab. If necessary, spray Release Agent around Pull Tab to soften glue and use Scraper to remove glue.
4. Clean area thoroughly to remove Release Agent residue.



### T-Puller

---

1. Place T-Puller over end of Pull Tab. Pull it backward until dent is raised.
2. Remove T-Puller.

3. Remove Pull Tab. If necessary, spray Release Agent around Pull Tab to soften glue and use Scraper to remove glue.
4. Clean area thoroughly to remove Release Agent residue.

## Lever Puller

---

Use on a small dent.

1. Place Lever Puller on the Pull Tab. Turn knob until both of the Puller's feet are flat against the vehicle's surface.



2. Slowly squeeze the Lever Puller's handles until there is a pop and the dent is raised. Stop when dent returns to normal surface level. Turn knob, if necessary, to increase pull.



3. Remove Lever Puller.
4. Remove Pull Tab. If necessary, spray Release Agent around Pull Tab to soften glue and use Scraper to remove glue.

5. Clean area thoroughly to remove Release Agent residue.



## Repairing High Spots

Use a hammer (sold separately) and Knockdown Tool or Shape Stick against raised spot until desired smoothness is reached.

### Knockdown Tool

1. Hold the Knockdown Tool over raised area and lightly tap the hammer on the head of the tool to push the raised area down.
2. Change tip by unscrewing it from the tool and screwing in the other one.



### Shape Sticks

Hold the desired Shape Stick over raised area and lightly tap hammer on the head of the tool to push the raised area down.

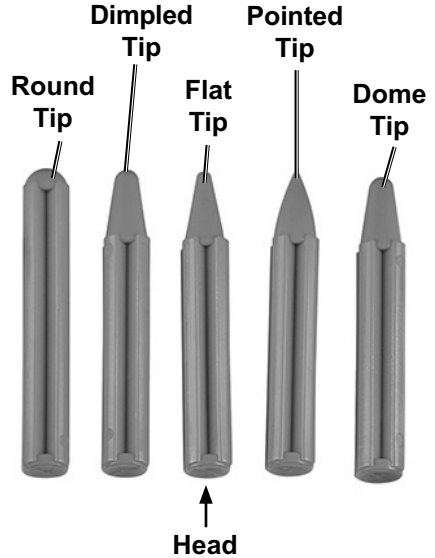

**MADDOX**  
SUPERIOR AUTOMOTIVE TOOLS

# PLEASE READ THE FOLLOWING CAREFULLY

THE MANUFACTURER AND/OR DISTRIBUTOR HAS PROVIDED THE PARTS LIST AND ASSEMBLY DIAGRAM IN THIS DOCUMENT AS A REFERENCE TOOL ONLY. NEITHER THE MANUFACTURER OR DISTRIBUTOR MAKES ANY REPRESENTATION OR WARRANTY OF ANY KIND TO THE BUYER THAT HE OR SHE IS QUALIFIED TO MAKE ANY REPAIRS TO THE PRODUCT, OR THAT HE OR SHE IS QUALIFIED TO REPLACE ANY PARTS OF THE PRODUCT. IN FACT, THE MANUFACTURER AND/OR DISTRIBUTOR EXPRESSLY STATES THAT ALL REPAIRS AND PARTS REPLACEMENTS SHOULD BE UNDERTAKEN BY CERTIFIED AND LICENSED TECHNICIANS, AND NOT BY THE BUYER. THE BUYER ASSUMES ALL RISK AND LIABILITY ARISING OUT OF HIS OR HER REPAIRS TO THE ORIGINAL PRODUCT OR REPLACEMENT PARTS THERETO, OR ARISING OUT OF HIS OR HER INSTALLATION OF REPLACEMENT PARTS THERETO.

## Parts List and Assembly Diagram

### Parts List

Part	Description	Qty	Part	Description	Qty
1	Lever Puller	1	14	Hot Glue Gun	1
2	Scraper	1	15	Pointed Tip Shape Stick	1
3	Rectangle Pull Tab, 1.20" L x 0.80" W	2	16	Round Tip Shape Stick	1
4	Rectangle Pull Tab, 1.40" L x 0.90" W	2	17	Slide Hammer	1
5	Rectangle Pull Tab, 1.92" L x 1.28" W	2	21	Round Pull Tab, Ø 1.25"	2
6	Knockdown Tool (with Pointed Tip)	1	22	Round Pull Tab, Ø 1.40"	2
7	T-Puller	1	23	Round Pull Tab, Ø 1.60"	2
8	Round Tip (for Knockdown Tool)	1	24	Oval Pull Tab, 1.34" L x 0.90" W	2
9	Curved Scraper	1	25	Oval Pull Tab, 1.60" L x 1.08" W	2
10	Flat Tip Shape Stick	1	26	Oval Pull Tab, 1.90" L x 1.30" W	2
11	Dome Tip Shape Stick	1	27	Round Pull Tab, Ø 0.60"	2
12	Dimpled Tip Shape Stick	1	28	Round Pull Tab, Ø 0.80"	2
13	Glue Stick	15	29	Round Pull Tab, Ø 1"	2
			30	Release Agent	1
			31	Case (not shown)	1

# Parts List

---

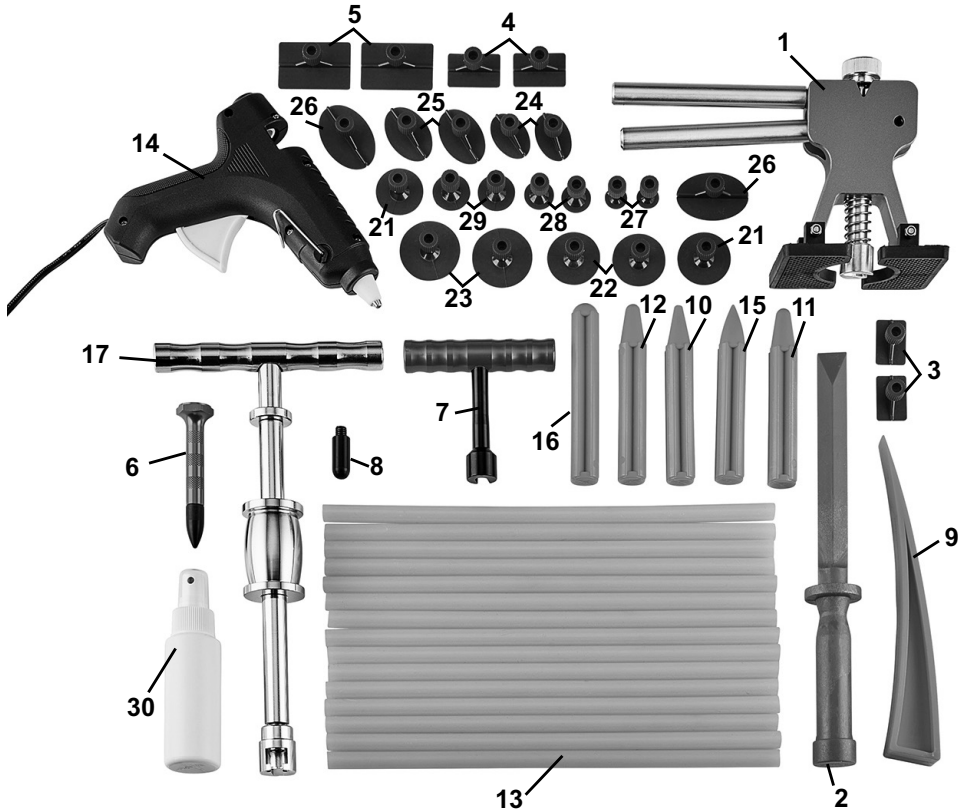

**Record Serial Number Here:** \_\_\_\_\_

**Note:** If product has no serial number, record month and year of purchase instead.

**Note:** Some parts are listed and shown for illustration purposes only, and are not available individually as replacement parts. Specify UPC 193175439307 when ordering parts.

## Limited 90 Day Warranty

Harbor Freight Tools Co. makes every effort to assure that its products meet high quality and durability standards, and warrants to the original purchaser that this product is free from defects in materials and workmanship for the period of 90 days from the date of purchase. This warranty does not apply to damage due directly or indirectly, to misuse, abuse, negligence or accidents, repairs or alterations outside our facilities, criminal activity, improper installation, normal wear and tear, or to lack of maintenance. We shall in no event be liable for death, injuries to persons or property, or for incidental, contingent, special or consequential damages arising from the use of our product. Some states do not allow the exclusion or limitation of incidental or consequential damages, so the above limitation of exclusion may not apply to you. THIS WARRANTY IS EXPRESSLY IN LIEU OF ALL OTHER WARRANTIES, EXPRESS OR IMPLIED, INCLUDING THE WARRANTIES OF MERCHANTABILITY AND FITNESS.

To take advantage of this warranty, the product or part must be returned to us with transportation charges prepaid. Proof of purchase date and an explanation of the complaint must accompany the merchandise. If our inspection verifies the defect, we will either repair or replace the product at our election or we may elect to refund the purchase price if we cannot readily and quickly provide you with a replacement. We will return repaired products at our expense, but if we determine there is no defect, or that the defect resulted from causes not within the scope of our warranty, then you must bear the cost of returning the product.

This warranty gives you specific legal rights and you may also have other rights which vary from state to state.

**MADDOX**  
SUPERIOR AUTOMOTIVE TOOLS

26677 Agoura Road • Calabasas, CA 91302 • 1-888-866-5797