

# HERCULES®

## Owner's Manual & Safety Instructions

23a

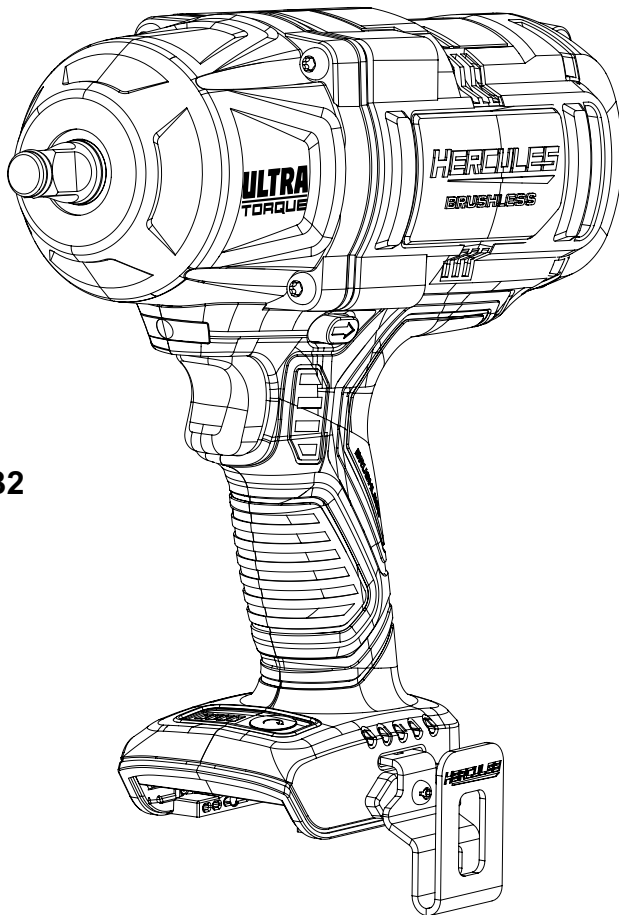

**Model  
HCB85B2**

**Battery and Charger Sold Separately  
20V 1/2" Brushless Ultra Torque Impact Wrench**

**⚠WARNING: To prevent serious injury, User must read and understand Owner's Manual. SAVE THIS MANUAL.**

When unpacking, make sure that the product is intact and undamaged.  
If any parts are missing or broken, please call 1-888-866-5797  
as soon as possible. Reference 58887.

# IMPORTANT SAFETY INFORMATION

## General Power Tool Safety Warnings

### **⚠️ WARNING**

Read all safety warnings, instructions, illustrations and specifications provided with this power tool. Failure to follow all instructions listed below may result in electric shock, fire and/or serious injury.

Save all warnings and instructions for future reference.

The term "power tool" in the warnings refers to your mains-operated (corded) power tool or battery-operated (cordless) power tool.

### Work Area Safety

- a. **Keep work area clean and well lit.** *Cluttered or dark areas invite accidents.*
- b. **Do not operate power tools in explosive atmospheres, such as in the presence of flammable liquids, gases or dust.** *Power tools create sparks which may ignite the dust or fumes.*
- c. **Keep children and bystanders away while operating a power tool.** *Distractions can cause you to lose control.*

### Electrical Safety

- a. **Power tool plugs must match the outlet.** *Never modify the plug in any way. Do not use any adapter plugs with earthed (grounded) power tools. Unmodified plugs and matching outlets will reduce risk of electric shock.*
- b. **Avoid body contact with earthed or grounded surfaces, such as pipes, radiators, ranges and refrigerators.** *There is an increased risk of electric shock if your body is earthed or grounded.*
- c. **Do not expose power tools to rain or wet conditions.** *Water entering a power tool will increase the risk of electric shock.*
- d. **Do not abuse the cord.** *Never use the cord for carrying, pulling or unplugging the power tool. Keep cord away from heat, oil, sharp edges or moving parts. Damaged or entangled cords increase the risk of electric shock.*
- e. **When operating a power tool outdoors, use an extension cord suitable for outdoor use.** *Use of a cord suitable for outdoor use reduces the risk of electric shock.*
- f. **If operating a power tool in a damp location is unavoidable, use a ground fault circuit interrupter (GFCI) protected supply.** *Use of a GFCI reduces the risk of electric shock.*

- g. **Hold the power tool by insulated gripping surfaces, when performing an operation where the fastener may contact hidden wiring or its own cord.** *Fasteners contacting a "live" wire may make exposed metal parts of the power tool "live" and could give the operator an electric shock.*

### Personal Safety

- a. **Stay alert, watch what you are doing and use common sense when operating a power tool. Do not use a power tool while you are tired or under the influence of drugs, alcohol or medication.** *A moment of inattention while operating power tools may result in serious personal injury.*
- b. **Use personal protective equipment. Always wear eye protection.** *Protective equipment such as dust mask, non-skid safety shoes, hard hat, or hearing protection used for appropriate conditions will reduce personal injuries.*
- c. **Prevent unintentional starting. Ensure the switch is in the off-position before connecting to power source and/or battery pack, picking up or carrying the tool.** *Carrying power tools with your finger on the switch or energizing power tools that have the switch on invites accidents.*
- d. **Remove any adjusting key or wrench before turning the power tool on.** *A wrench or a key left attached to a rotating part of the power tool may result in personal injury.*
- e. **Do not overreach. Keep proper footing and balance at all times.** *This enables better control of the power tool in unexpected situations.*
- f. **Dress properly. Do not wear loose clothing or jewelry. Keep your hair, clothing and gloves away from moving parts.** *Loose clothes, jewelry or long hair can be caught in moving parts.*
- g. **If devices are provided for the connection of dust extraction and collection facilities, ensure these are connected and properly used.** *Use of dust collection can reduce dust-related hazards.*
- h. **Do not let familiarity gained from frequent use of tools allow you to become complacent and ignore tool safety principles.** *A careless action can cause severe injury within a fraction of a second.*

- i. Only use safety equipment that has been approved by an appropriate standards agency. Unapproved safety equipment may not provide adequate protection. Eye protection must be ANSI-approved and breathing protection must be NIOSH-approved for the specific hazards in the work area.
- j. Do not lay the tool down until it has come to a complete stop. Moving parts can grab the surface and pull the tool out of your control.
- k. When using a handheld power tool, maintain a firm grip on the tool with both hands to resist starting torque.
- l. Do not leave the tool unattended when the Battery Pack is connected. Turn off the tool, and remove the Battery Pack before leaving.
- m. This product is not a toy. Keep it out of reach of children.
- n. People with pacemakers should consult their physician(s) before use. Electromagnetic fields in close proximity to heart pacemaker could cause pacemaker interference or pacemaker failure.
- o. The warnings, precautions, and instructions discussed in this instruction manual cannot cover all possible conditions and situations that may occur. It must be understood by the operator that common sense and caution are factors which cannot be built into this product, but must be supplied by the operator.
- e. **Maintain power tools and accessories. Check for misalignment or binding of moving parts, breakage of parts and any other condition that may affect the power tool's operation. If damaged, have the power tool repaired before use. Many accidents are caused by poorly maintained power tools.**
- f. **Keep cutting tools sharp and clean. Properly maintained cutting tools with sharp cutting edges are less likely to bind and are easier to control.**
- g. **Use the power tool, accessories and tool bits etc. in accordance with these instructions, taking into account the working conditions and the work to be performed. Use of the power tool for operations different from those intended could result in a hazardous situation.**
- h. **Keep handles and grasping surfaces dry, clean and free from oil and grease. Slippery handles and grasping surfaces do not allow for safe handling and control of the tool in unexpected situations.**

### Power Tool Use and Care

- a. **Do not force the power tool. Use the correct power tool for your application.** *The correct power tool will do the job better and safer at the rate for which it was designed.*
- b. **Do not use the power tool if the switch does not turn it on and off.** *Any power tool that cannot be controlled with the switch is dangerous and must be repaired.*
- c. **Disconnect the plug from the power source and/or remove the battery pack, if detachable, from the power tool before making any adjustments, changing accessories, or storing power tools.** *Such preventive safety measures reduce the risk of starting the power tool accidentally.*
- d. **Store idle power tools out of the reach of children and do not allow persons unfamiliar with the power tool or these instructions to operate the power tool.** *Power tools are dangerous in the hands of untrained users.*

### Service

- a. **Have your power tool serviced by a qualified repair person using only identical replacement parts.** *This will ensure that the safety of the power tool is maintained.*
- b. **Never service damaged BATTERY packs.** *Service of BATTERY packs should only be performed by the manufacturer or authorized service providers.*
- c. Maintain labels and nameplates on the tool. These carry important safety information. If unreadable or missing, contact Harbor Freight Tools for a replacement.

### Battery Tool Use and Care

- a. **Prevent unintentional starting.** *Ensure the switch is in the off-position before connecting to battery pack, picking up or carrying the power tool. Carrying the power tool with your finger on the switch or energizing power tool that have the switch on invites accidents.*
- b. **Disconnect the battery pack from the power tool before making any adjustments, changing accessories, or storing power tool.** *Such preventive safety measures reduce the risk of starting the power tool accidentally.*
- c. **Recharge only with the charger specified by the manufacturer.** *A charger that is suitable for one type of battery pack may create a risk of fire when used with another battery pack.*
- d. **Use power tools only with specifically designated battery packs.** *Use of any other battery packs may create a risk of injury and fire.*

## Lithium Battery Safety Warnings



### LITHIUM BATTERIES STORE A LARGE AMOUNT OF ENERGY AND WILL VENT FIRE OR EXPLODE IF MISTREATED:

- e. When battery pack is not in use, keep it away from other metal objects, like paper clips, coins, keys, nails, screws or other small metal objects, that can make a connection from one terminal to another. *Shorting the battery terminals together may cause burns or a fire.*
- f. Under abusive conditions, liquid may be ejected from the battery; avoid contact. *If contact accidentally occurs, flush with water. If liquid contacts eyes, additionally seek medical help. Liquid ejected from the battery may cause irritation or burns.*
- g. Do not use a battery pack or power tool that is damaged or modified. *Damaged or modified batteries may exhibit unpredictable behavior resulting in fire, explosion or risk of injury.*
- h. Do not expose a battery pack or power tool to fire or excessive temperature. *Exposure to fire or temperature above 140°F may cause explosion.*
- i. Follow all charging instructions and do not charge the battery pack or power tool outside of the temperature range specified in the instructions. *Charging improperly or at temperatures outside of the specified range may damage the battery and increase the risk of fire.*
- j. Have servicing performed by a qualified repair person using only identical replacement parts. *This will ensure that the safety of the product is maintained.*
- k. Do not modify or attempt to repair the power tool or the battery pack except as indicated in the instructions for use and care.



The battery Charger gets hot during use. The Charger's heat can build up to unsafe levels and create a fire hazard if it does not receive adequate ventilation, due to an electrical fault, or if it is used in a hot environment. Do not place the Charger on a flammable surface. Do not obstruct any vents on the Charger. **Especially avoid placing the Charger on carpets and rugs; they are not only flammable, but they also obstruct vents under the Charger.** Place the Charger on a stable, solid, nonflammable surface (such as a stable metal workbench or concrete floor) at least 1 foot away from all flammable objects, such as drapes or walls. Keep a fire extinguisher and a smoke detector in the area. Frequently monitor the Charger and Battery Pack while charging.

- a. Keep Battery Pack dry.
- b. DO NOT DO ANY OF THE FOLLOWING TO THE BATTERY PACK:
  - Open,
  - Drop,
  - Short-circuit,
  - Puncture,
  - Incinerate, or
  - Expose to temperatures greater than 140°F.
- c. Charge Battery Pack only according to its Charger's instructions.
- d. Inspect Battery Pack before every use; do not use or charge if damaged.

## Vibration Safety

This tool vibrates during use. Repeated or long-term exposure to vibration may cause temporary or permanent physical injury, particularly to the hands, arms and shoulders. To reduce the risk of vibration-related injury:

- a. Anyone using vibrating tools regularly or for an extended period should first be examined by a doctor and then have regular medical check-ups to ensure medical problems are not being caused or worsened from use. Pregnant women or people who have impaired blood circulation to the hand, past hand injuries, nervous system disorders, diabetes, or Raynaud's Disease should not use this tool. If you feel any symptoms related to vibration (such as tingling, numbness, and white or blue fingers), seek medical advice as soon as possible.
- b. Do not smoke during use. Nicotine reduces the blood supply to the hands and fingers, increasing the risk of vibration-related injury.
- c. Wear suitable gloves to reduce the vibration effects on the user.
- d. Use tools with the lowest vibration when there is a choice.
- e. Include vibration-free periods each day of work.
- f. Grip tool as lightly as possible (while still keeping safe control of it). Let the tool do the work.
- g. To reduce vibration, maintain the tool as explained in this manual. If any abnormal vibration occurs, stop use immediately.

## GROUNDING

### **⚠ WARNING**



**TO PREVENT ELECTRIC SHOCK AND DEATH FROM INCORRECT GROUNDING:**

**Check with a qualified electrician if you are in doubt as to whether the outlet is properly grounded. Do not modify the power cord plug provided with the charger. Do not use the charger if the power cord or plug is damaged. If damaged, have it repaired by a service facility before use. If the plug will not fit the outlet, have a proper outlet installed by a qualified electrician.**

## Extension Cords

**Note:** Extension cords must not be used with this item's Charger.

## Warning Symbols and Definitions

 This is the safety alert symbol. It is used to alert you to potential personal injury hazards. Obey all safety messages that follow this symbol to avoid possible injury or death.









 **DANGER** Indicates a hazardous situation which, if not avoided, will result in death or serious injury.

 **WARNING** Indicates a hazardous situation which, if not avoided, could result in death or serious injury.

 **CAUTION** Indicates a hazardous situation which, if not avoided, could result in minor or moderate injury.

**NOTICE** Addresses practices not related to personal injury.

## Symbology

	Volts
	Direct Current
	Amperes
$n_0$ xxxx/min.	No Load Revolutions per Minute (RPM)
	WARNING marking concerning Risk of Eye Injury. Wear ANSI-approved safety goggles with side shields.
	Read the manual before set-up and/or use.
	WARNING marking concerning Risk of Fire. Do not cover Charger ventilation ducts. Charge on fireproof surface only.
	WARNING marking concerning Risk of Electric Shock. Properly connect Charger's power cord to appropriate outlet.
	WARNING marking concerning Risk of Explosion. Do not puncture, short, or open battery packs and do not charge damaged battery packs.

## Specifications

Battery Type	Hercules 20V Li-Ion (57373, sold separately)
Charger Type	Hercules 20V Li-Ion (56559, sold separately)
Speed	$n_0$ : 0-1600/min
Blows per minute	2100 BPM
Anvil Size	1/2"

## Setup - Before Use:



Read the **ENTIRE IMPORTANT SAFETY INFORMATION** section at the beginning of this manual including all text under subheadings therein before set up or use of this product.

## Charging

Charge battery pack after unpacking and before using this tool. Follow instructions included with battery charger (battery pack and charger sold separately).

## Functions

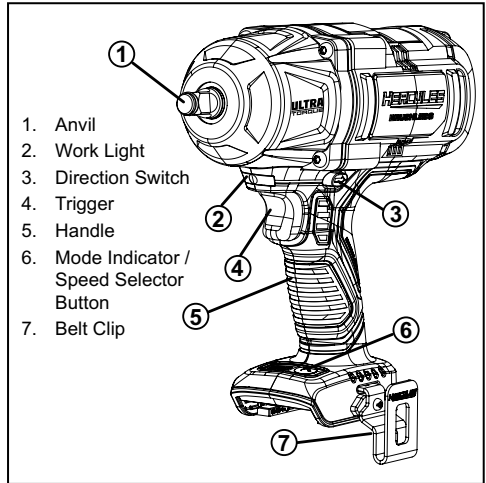

# HERCULES®

## OPERATING INSTRUCTIONS



Read the **ENTIRE IMPORTANT SAFETY INFORMATION** section at the beginning of this manual including all text under subheadings therein before set up or use of this product.

### Tool Changing

#### Bit Installation

**CAUTION!** Only use impact rated accessories with this tool. Other accessories may shatter, chip, or crack during operation.

Connect an appropriate, impact rated square drive socket (sold separately) onto the Anvil.

#### Attaching Belt Clip

Attach Belt Clip to Handle using supplied Screw. Clip may be attached to either side.

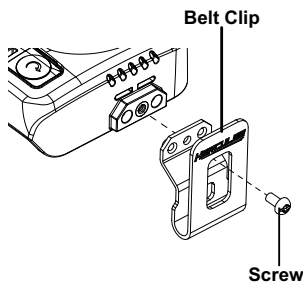

## Setting and Testing

### **⚠**WARNING

**TO PREVENT SERIOUS INJURY FROM ACCIDENTAL OPERATION:**

**Make sure that the Trigger is in the off-position and remove its Battery Pack before performing any procedure in this section.**

1. Ensure bit is correctly installed in Impact Wrench.
2. Make sure that the Trigger is in the off-position, then insert a fully charged Battery Pack into the base of the Impact Wrench, making sure that it clicks into place securely.
3. Press the Trigger and test run tool for at least 30 seconds.
4. If abnormal noise or vibration occurs, have the problem corrected before further use.
5. Release Trigger and disconnect Battery Pack.

### Workpiece and Work Area Set Up

1. Designate a work area that is clean and well lit. The work area must not allow access by children or pets to prevent distraction and injury.
2. Secure loose workpieces using a vise or clamps (not included) to prevent movement while working.
3. There must not be objects, such as utility lines, nearby that will present a hazard while working.

# HERCULES®



## General Instructions for Use

1. Make sure that the Trigger is in the off-position, then insert a fully charged Battery Pack into the base of the Impact Wrench, making sure that it clicks into place securely.

**CAUTION!** The tool will restart automatically if stalled.

2. Set Direction Switch.

**Forward:** Push Switch in on right side (arrow pointing forward) for clockwise rotation.

**Reverse:** Push Switch in on left side (arrow pointing backward) for counter-clockwise rotation.

**Trigger Lock:** Push Switch to the center to lock the Trigger.

**CAUTION!** Set Direction Switch to center Trigger Lock position during set up, when changing sockets or when tool is idle.

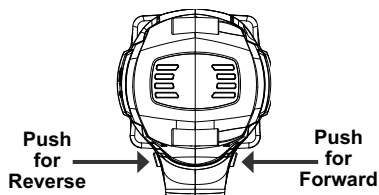

Push to Center to  
LOCK TRIGGER

**NOTICE:** Do not change direction of rotation while Anvil is rotating. Wait until Anvil has come to a complete stop before changing direction.

3. Use two hands to hold the tool.
4. Push socket over fastener and squeeze Trigger slowly.
5. When finished, release and lock Trigger.
6. To prevent accidents, turn off the tool and remove its Battery Pack after use. Clean, then store the tool indoors out of children's reach.

**Note:** The amount of actual torque will vary depending on the cleanliness and condition of the threads and other factors. If tightening critical components, chase threads before assembling components and check the actual torque applied to the fastener with a mechanical torque wrench (not supplied).

## Changing Mode

1. Tool Mode can be adjusted. Adjusting Mode changes the RPM and BPM range of the tool. There are four different modes. Mode 1 is the slowest, while Mode 3 is the fastest. To see current mode, pull and release Trigger to turn on tool. The Mode Indicator will light up.
2. To adjust the mode, press the Speed Selector Button to cycle through different modes.
3. Mode 4 in forward, runs tool and shuts off when torque is reached. Mode 4 in reverse, runs tool at full RPM until nut breaks free. Then tool slows RPM down to remove nut.

## Changing Speed

1. Speed of the switched-on tool depends on how far the Trigger is pressed down.
2. Light Pressure on the Trigger results in a low speed. Use more pressure on the Trigger to increase speed.

# HERCULES®

## Maintenance and Servicing Instructions



Procedures not specifically explained in this manual must be performed only by a qualified technician.

### **⚠️ WARNING**

#### **TO PREVENT SERIOUS INJURY FROM ACCIDENTAL OPERATION:**

Make sure that the Trigger is in the off-position and remove its Battery Pack before performing any procedure in this section.

#### **TO PREVENT SERIOUS INJURY FROM TOOL FAILURE:**

Do not use damaged equipment.

If abnormal noise or vibration occurs, have the problem corrected before further use.

## Cleaning, Maintenance, and Lubrication

1. **BEFORE EACH USE**, inspect the general condition of the tool. Check for:
  - leaking, swollen, or cracked battery pack,
  - loose hardware,
  - misalignment or binding of moving parts,
  - cracked or broken parts, and
  - any other condition that may affect its safe operation.
2. **AFTER USE**, wipe external surfaces of the tool with clean cloth.
3. **Li-Ion BATTERY MUST BE RECYCLED OR DISPOSED OF PROPERLY.**  
Do not short, incinerate or open battery.
4. Disconnect battery pack and store battery pack, charger, and tool in dry, indoor area out of reach of children and away from metal objects (i.e., paperclips, coins) to prevent shorting.

## Troubleshooting

Problem	Possible Causes	Likely Solutions
Tool will not start.	<ol style="list-style-type: none"> <li>1. Battery Pack not properly connected.</li> <li>2. Battery Pack not properly charged.</li> <li>3. Battery Pack burnt-out.</li> <li>4. Internal damage or wear. (Trigger, for example.)</li> </ol>	<ol style="list-style-type: none"> <li>1. Remove Battery Pack, make sure there are no obstructions, reinsert the Battery Pack according to its shape (it should only fit one way), and press firmly until the Battery Pack locks in place.</li> <li>2. Make sure Charger is connected and operating properly. Give enough time for Battery Pack to recharge properly.</li> <li>3. Dispose of old Battery Pack properly or recycle. Replace Battery Pack.</li> <li>4. Have technician service tool.</li> </ol>
Tool operates slowly.	<ol style="list-style-type: none"> <li>1. Forcing tool to work too fast.</li> <li>2. Battery Pack wearing out.</li> </ol>	<ol style="list-style-type: none"> <li>1. Allow tool to work at its own rate.</li> <li>2. Dispose of old Battery Pack properly or recycle. Replace Battery Pack.</li> </ol>
Performance decreases over time.	Internal wear or damage.	Have qualified technician service tool
Excessive noise or rattling.	Internal damage or wear. (bearings, for example.)	Have technician service tool.
Overheating.	<ol style="list-style-type: none"> <li>1. Forcing tool to work too fast.</li> <li>2. Blocked motor housing vents.</li> </ol>	<ol style="list-style-type: none"> <li>1. Allow tool to work at its own rate.</li> <li>2. Wear ANSI-approved safety goggles and NIOSH-approved dust mask/respirator while blowing dust out of motor using compressed air.</li> </ol>
 <p><b>Follow all safety precautions whenever diagnosing or servicing the tool. Disconnect Battery Pack and Charger power supply before service.</b></p>		

**Record Product's Serial Number Here:** \_\_\_\_\_

**Note:** If product has no serial number, record month and year of purchase instead.

**Note:** Replacement parts may be available for this item. Visit [harborfreight.com](http://harborfreight.com) for a list of in stock parts. Specify UPC193175504548 when ordering parts.

## **5-YEAR LIMITED WARRANTY**

This Hercules tool is warranted to the original purchaser to be free from defects in materials and workmanship for a period of five (5) years beginning on the date of purchase. This warranty does not cover battery packs and battery chargers, which are covered under separate warranties. To obtain warranty service, visit your local Harbor Freight retail store. Warranty registration is not required. The product or part must be returned to us with proof of purchase (e.g. in-store receipt or packing slip/invoice) and may require shipment by purchaser to a service center at purchaser's expense. If our inspection verifies a covered defect in materials or workmanship during the warranty period, we will, at our option, repair or replace the defective product. We will return repaired products within a reasonable time at our expense, but if we determine that there is no defect, or that the defect resulted from causes not within the scope of our warranty, then we will return the product to you if you pay return shipping costs.

This warranty does not cover any failure or damage that we determine is due directly or indirectly to normal wear and tear, misuse, use not for the intended purpose or not in accordance with the product manual, abuse, accident, rental, modification or alteration, unauthorized repair, improper installation, neglect, lack of maintenance, or any other failure not arising from defective materials or workmanship. Fraudulent returns or claims will be denied. The repair or replacement described in this warranty shall be your sole and exclusive remedy. THIS WARRANTY IS EXCLUSIVE AND IN LIEU OF ALL OTHER EXPRESS WARRANTIES, WRITTEN OR ORAL, AND ANY IMPLIED WARRANTIES ARE DISCLAIMED TO THE EXTENT PERMITTED BY LAW AND OTHERWISE LIMITED TO THE DURATION OF THE EXPRESS WARRANTY HEREIN. HARBOR FREIGHT SHALL NOT BE LIABLE UNDER ANY CIRCUMSTANCES FOR ANY INCIDENTAL, INDIRECT, SPECIAL, CONSEQUENTIAL, OR PUNITIVE DAMAGES OR COSTS ARISING FROM THIS WARRANTY OR THE USE OF THIS PRODUCT. SOME STATES DO NOT ALLOW LIMITATIONS ON HOW LONG AN IMPLIED WARRANTY LASTS OR THE EXCLUSION OR LIMITATION OF INCIDENTAL OR CONSEQUENTIAL DAMAGES, SO THESE LIMITATIONS MAY NOT APPLY TO YOU. THIS WARRANTY GIVES YOU SPECIFIC LEGAL RIGHTS, AND YOU MAY ALSO HAVE OTHER RIGHTS WHICH VARY FROM STATE TO STATE.

# **HERCULES®**

26677 Agoura Road • Calabasas, CA 91302 • 1-888-866-5797