

Owner's Manual & Safety Instructions

Save This Manual Keep this manual for the safety warnings and precautions, assembly, operating, inspection, maintenance and cleaning procedures. Write the product's serial number in the back of the manual near the assembly diagram (or month and year of purchase if product has no number). Keep this manual and the receipt in a safe and dry place for future reference.

23e

PITTSBURGH™

AIR/HYDRAULIC BOTTLE JACK



(12 Ton Jack shown)

12 Ton	59425
Weight Capacity	12 Tons (24,000 lb.)
Maximum Height	20-1/2"
Minimum Height	10-1/4"
Max Air Pressure	300 PSI
Air Inlet	1/4" - 18 NPT

20 Ton	59426
Weight Capacity	20 Tons (40,000 lb.)
Maximum Height	19-7/8"
Minimum Height	10-1/4"
Max Air Pressure	300 PSI
Air Inlet	1/4" - 18 NPT

Visit our website at: <http://www.harborfreight.com>
Email our technical support at: productsupport@harborfreight.com

When unpacking, make sure that the product is intact and undamaged. If any parts are missing or broken, please call 1-888-866-5797 as soon as possible.

Copyright© 2022 by Harbor Freight Tools®. All rights reserved.
No portion of this manual or any artwork contained herein may be reproduced in any shape or form without the express written consent of Harbor Freight Tools. Diagrams within this manual may not be drawn proportionally. Due to continuing improvements, actual product may differ slightly from the product described herein.
Tools required for assembly and service may not be included.

⚠ WARNING





Read this material before using this product. Failure to do so can result in serious injury.
SAVE THIS MANUAL.

Table of Contents

Safety	2	Maintenance	10
Setup	4	Parts List and Diagram	12
Operation.....	8	Warranty	15

PITTSBURGH™

WARNING SYMBOLS AND DEFINITIONS

	This is the safety alert symbol. It is used to alert you to potential personal injury hazards. Obey all safety messages that follow this symbol to avoid possible injury or death.
	Indicates a hazardous situation which, if not avoided, will result in death or serious injury.
	Indicates a hazardous situation which, if not avoided, could result in death or serious injury.
	Indicates a hazardous situation which, if not avoided, could result in minor or moderate injury.
	Addresses practices not related to personal injury.

IMPORTANT SAFETY INSTRUCTIONS

1. Study, understand, and follow all instructions before operating this device.
2. Do not exceed rated capacity.
3. Use only on a hard, level surface capable of supporting the load.
4. Lifting device only. Immediately after lifting, support the vehicle with appropriate means.
5. Do not move or dolly the vehicle while on the jack.
6. Failure to heed these markings may result in personal injury and/or property damage.
7. Lift only areas of the vehicle as specified by the vehicle manufacturer.
8. No alterations shall be made to this product.
9. Only attachments and/or adapters supplied by the manufacturer shall be used.
10. Never work on, under or around a load supported only by this device.
11. Do not adjust safety valve.
12. Wear ANSI-approved safety goggles and heavy-duty work gloves during use.
13. Keep clear of load while lifting and lowering.
14. Lower load slowly.
15. Apply parking brake and chock tires before lifting vehicle.
16. Lift vehicle only at manufacturer recommended locations.
17. Inspect before every use; do not use if parts are loose or damaged.
18. Do not use for aircraft purposes.
19. The warnings, precautions, and instructions discussed in this manual cannot cover all possible conditions and situations that may occur. The operator must understand that common sense and caution are factors, which cannot be built into this product, but must be supplied by the operator.

IMPORTANT! Before first use:

Check hydraulic fluid level and fill to 1/4" below the fill port as needed. Thoroughly test the Jack for proper operation. If it does not work properly, bleed air from its hydraulic system as stated in Bleeding Instructions on page 5.





Air Source

- 

Never connect to an air source that is capable of exceeding 200 psi. Over pressurizing the tool may cause bursting, abnormal operation, breakage of the tool or serious injury to persons. Use only clean, dry, regulated compressed air at the rated pressure or within the rated pressure range as marked on the tool. Always verify prior to using the tool that the air source has been adjusted to the rated air pressure or within the rated air-pressure range.
- Never use oxygen, carbon dioxide, combustible gases or any bottled gas as an air source for the tool.** Such gases are capable of explosion and serious injury to persons.

Symbol Definitions

Symbol	Property or statement
PSI	Pounds per square inch of pressure
CFM	Cubic Feet per Minute flow
SCFM	Cubic Feet per Minute flow at standard conditions
NPT	National pipe thread, tapered

Symbol	Property or statement
	WARNING marking concerning Risk of Eye Injury. Wear ANSI-approved eye protection.
	WARNING marking concerning Risk of Hearing Loss. Wear hearing protection.
	WARNING marking concerning Risk of Respiratory Injury. Wear NIOSH-approved dust mask/respirator.
	WARNING marking concerning Risk of Explosion.



SAVE THESE INSTRUCTIONS.

Initial Tool Set Up



Read the **ENTIRE IMPORTANT SAFETY INSTRUCTIONS** section at the beginning of this manual including all text under subheadings therein before set up or use of this product.

Components and Controls

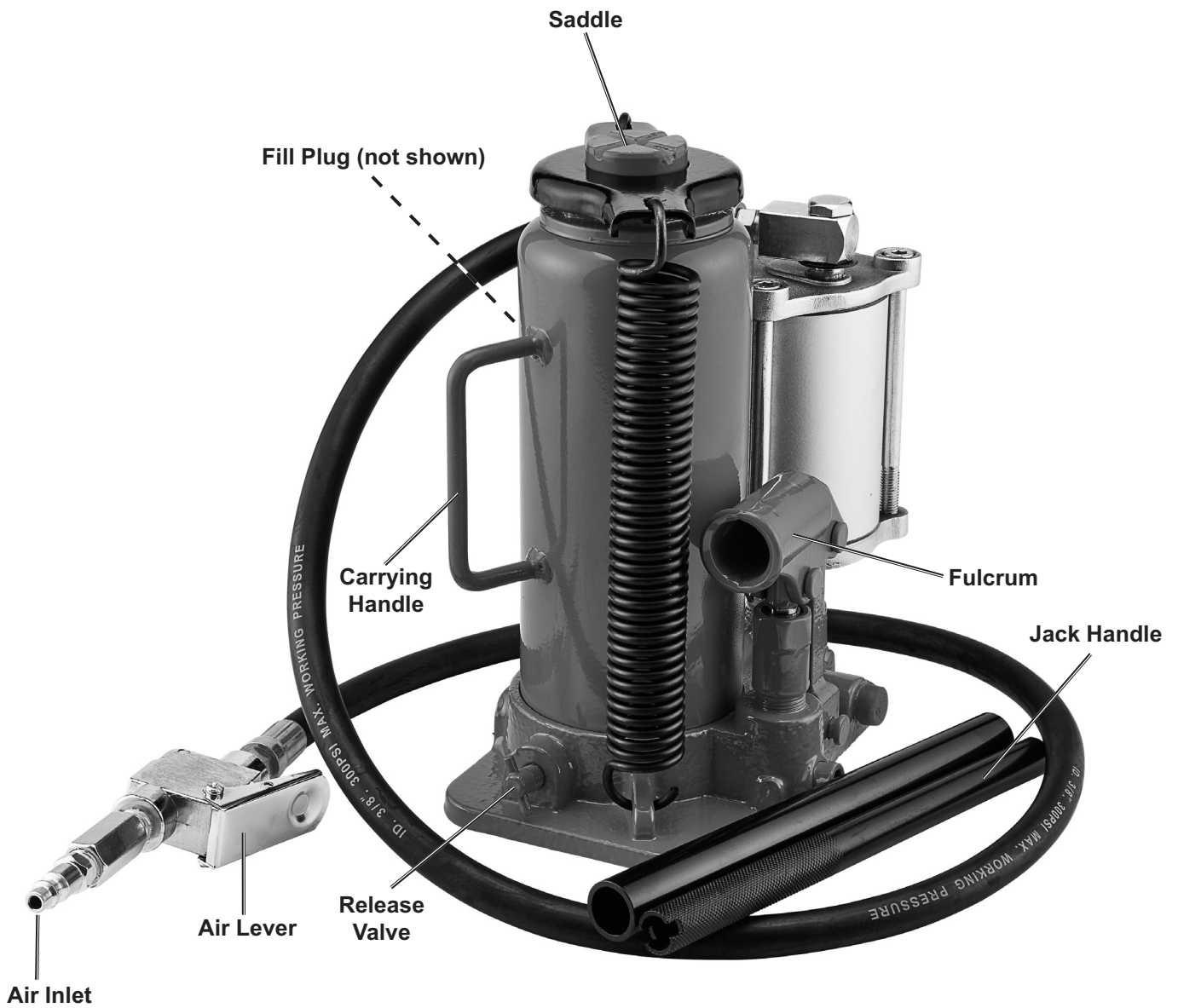

Bleeding Instructions

Before each use or if Jack performance decreases, check for excessive air and proper hydraulic fluid level in Jack. If Jack appears not to be working properly, it may be necessary to purge its hydraulic system of excessive air as follows:

1. Assemble the Jack Handle by pushing the two sections together.
2. Remove Fill Plug. Fill with hydraulic fluid (sold separately) to full level, if necessary.
3. Place the slotted end of the Jack Handle over the Release Valve, then turn *counterclockwise* to open the Release Valve.
4. Insert the Jack Handle into the Fulcrum, apply downward pressure to the Saddle, then pump the Jack Handle quickly several times.
5. Check fluid level and, if necessary, top off with hydraulic fluid.
6. Close the Release Valve by turning it *clockwise*, then replace Fill Plug.

IMPORTANT: After bleeding the Jack, test the Jack for proper operation prior to its actual use.

7. If, after bleeding, the Jack does not appear to be working properly, do not use it until repaired by a qualified service technician.

Air Supply

⚠ WARNING



TO PREVENT SERIOUS INJURY FROM EXPLOSION:

Use only clean, dry, regulated, compressed air to power this tool. Do not use oxygen, carbon dioxide, combustible gases, or any other bottled gas as a power source for this tool.

1. Incorporate a filter, regulator with pressure gauge, oiler, in-line shutoff valve, and quick coupler for best service, as shown on Figure A: Portable Air Supply Setup on page 6 and Figure B: Stationary Air Supply Setup on page 7. **An in-line shutoff ball valve is an important safety device because it controls the air supply even if the air hose is ruptured. The shutoff valve should be a ball valve because it can be closed quickly.**
2. Attach an air hose (not included) to the compressor's air outlet. Connect the air hose to the Jack's Air Inlet. Other components, such as a connector and quick coupler, will make operation more efficient, but are not mandatory.
3. Turn the tool's throttle or switch to the off position; refer to Operation section for description of controls.
4. Close the in-line shutoff valve between the compressor and the tool.
5. Turn on the air compressor according to the manufacturer's directions and allow it to build up pressure until it cycles off.
6. Adjust the air compressor's output regulator so that the air output is enough to properly power the tool, but the output will not exceed the tool's maximum air pressure at any time. Adjust the pressure gradually, while checking the air output gauge to set the right pressure range.
7. Inspect the air connections for leaks. Repair any leaks found.
8. If the tool will not be used at this time, turn off and detach the air supply, safely discharge any residual air pressure, and release the throttle and/or turn the switch to its off position to prevent accidental operation.

Note: If an automatic oiler system is not used, add a few drops of Pneumatic Tool Oil to the airline connection before operation. Add a few more drops after each hour of continual use.

⚠ WARNING! TO PREVENT SERIOUS INJURY FROM ACCIDENTAL OPERATION:

Do not install a female quick coupler on the tool. Such a coupler contains an air valve that will allow the air tool to retain pressure and operate accidentally after the air supply is disconnected.

Note: Air flow, and therefore tool performance, can be hindered by undersized air supply components. The air hose must be long enough to reach the work area with enough extra length to allow free movement while working.

Note: Residual air pressure should not be present after the tool is disconnected from the air supply. However, it is a good safety measure to attempt to discharge the tool in a safe fashion after disconnecting to ensure that the tool is disconnected and unpowered.

Figure A: Portable Air Supply Setup

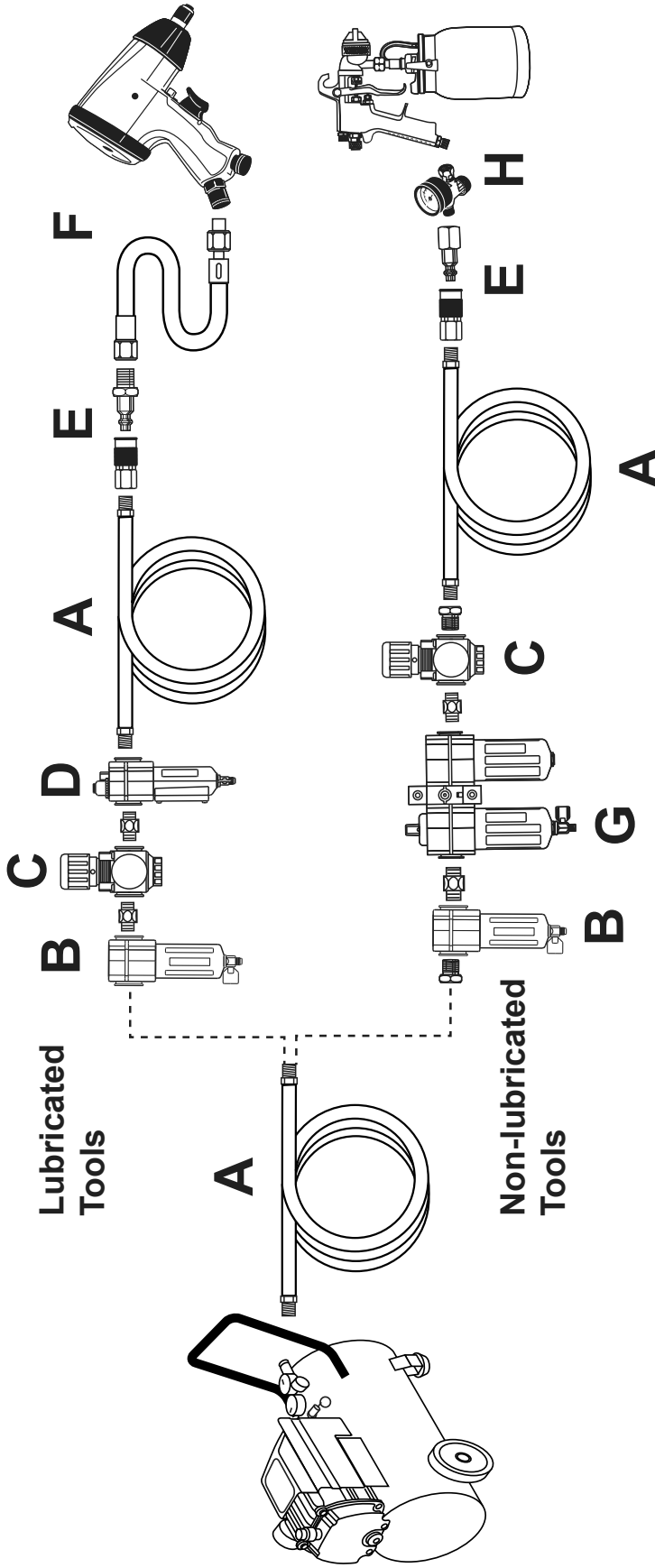

Description	Function
A Air Hose	Connects air to tool
B Filter	Prevents dirt and condensation from damaging tool or workpiece
C Regulator	Adjusts air pressure to tool
D Lubricator (optional)	For air tool lubrication
E Coupler and Plug	Provides quick connection and release
F Leader Hose (optional)	Increases coupler life
G Air Cleaner / Dryer (optional)	Prevents water vapor from damaging workpiece
H Air Adjusting Valve (optional)	For fine tuning airflow at tool

Figure B: Stationary Air Supply Setup

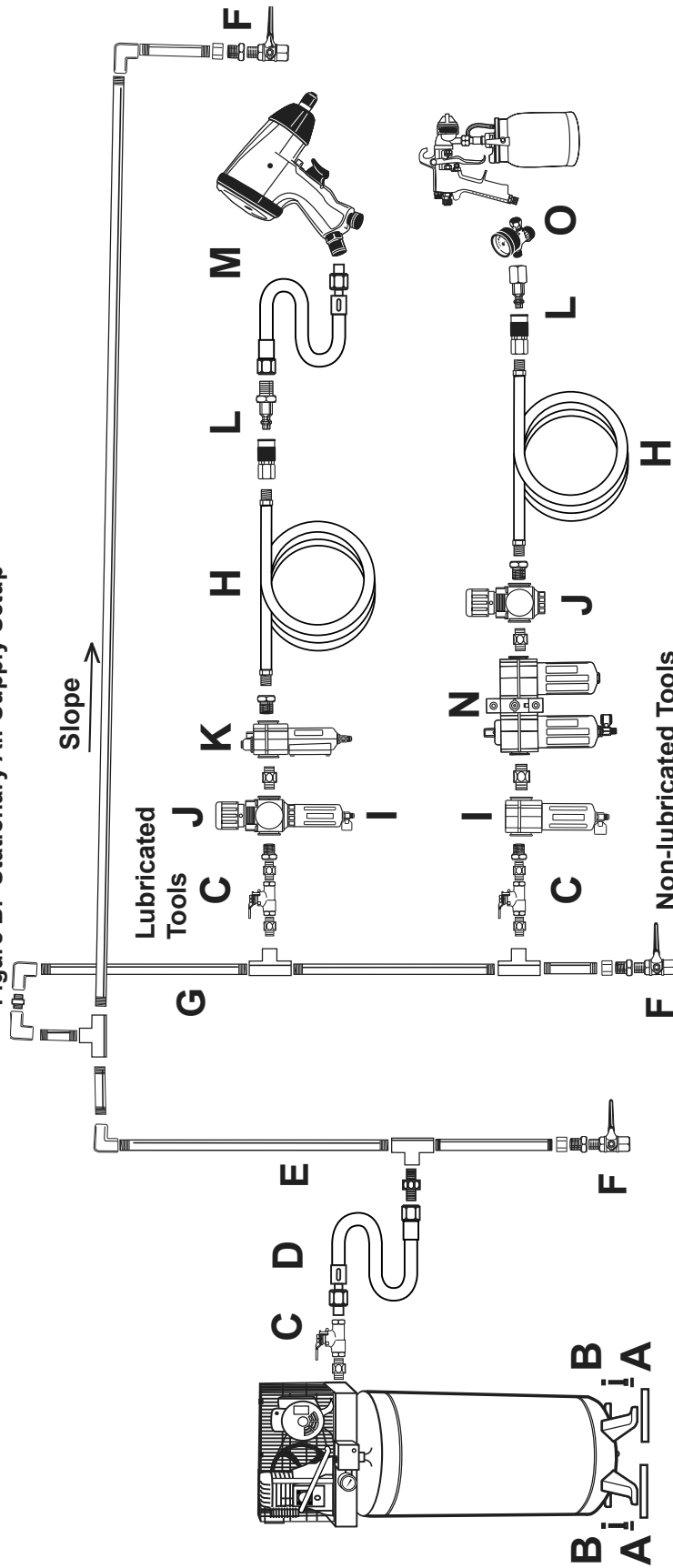

	Description	Function
A	Vibration Pads	For noise and vibration reduction
B	Anchor Bolts	Secures air compressor in place
C	Ball Valve	Isolates sections of system for maintenance
D	Isolation Hose	For vibration reduction
E	Main Air Line - 3/4" minimum recommended	Distributes air to branch lines
F	Ball Valve	To drain moisture from system
G	Branch Air Line - 1/2" minimum recommended	Brings air to point of use
H	Air Hose	Connects air to tool
I	Filter	Prevents dirt and condensation from damaging tool or workpiece
J	Regulator	Adjusts air pressure to tool
K	Lubricator (optional)	For air tool lubrication
L	Coupler and Plug	Provides quick connection and release
M	Leader Hose (optional)	Increases coupler life
N	Air Cleaner / Dryer (optional)	Prevents water vapor from damaging workpiece
O	Air Adjusting Valve (optional)	For fine tuning airflow at tool

Operating Instructions



Read the **ENTIRE IMPORTANT SAFETY INFORMATION** section at the beginning of this manual including all text under subheadings therein before set up or use of this product.

WARNING

Park vehicle on a flat, level, solid, surface safely away from oncoming traffic. Turn off the vehicle's engine. Place the vehicle's transmission in "PARK" (if automatic) or in its lowest gear (if manual). Set the vehicle's emergency brake. Then, chock the wheels that are not being lifted.

Raising a Vehicle

1. Place the slotted end of the Jack Handle over the Release Valve. Turn the Release Valve completely *counterclockwise* to lower the Jack. Then turn the Release Valve completely *clockwise* to close the Release Valve.
2. Carefully position the Saddle under the vehicle manufacturer's recommended lifting point. (See vehicle manufacturer's owner's manual for location of frame lifting point.)
3. Raise the Screw Cap Extension by turning it *counterclockwise*.



4. Pneumatic Operation:

- a. Connect the compressor's air hose to the Air Inlet.
- b. Release the Air Lever Lock, then depress the Air Lever until the Saddle has nearly reached the vehicle lifting point.
- c. Position the Jack at 90° to the vehicle's lifting point to ensure the Saddle and vehicle lifting point are in alignment. If not, reposition the Jack before lifting.
- d. Continue to depress the Air Lever. Once the vehicle is raised, place the Air Lever Lock in its locked position.

Note: If the tool requires more force to accomplish the task, verify that the tool receives sufficient, unobstructed airflow (CFM) and increase the pressure (PSI) output of the regulator up to the maximum air pressure rating of this tool.

CAUTION! TO PREVENT INJURY FROM TOOL OR ACCESSORY FAILURE:

Do not exceed the tool's maximum air pressure rating.

If the tool still does not have sufficient force at maximum pressure and sufficient airflow, then a larger tool may be required.

5. Manual Operation:

- a. Place the Jack Handle into the Fulcrum.
 - b. Pump the Jack Handle until the Saddle has nearly reached the vehicle lifting point.
 - c. Position the Jack at 90° to the vehicle's lifting point to ensure the Saddle and vehicle lifting point are in alignment. If not, reposition the Jack before lifting.
 - d. Continue to pump the Jack Handle until the vehicle is raised.
6. Set properly-rated jack stands (not included) to the same minimum practical height according to the manufacturer's instructions, making sure they lock securely into position.
 7. Position the jack stand saddles under the vehicle manufacturer's recommended support points.
- WARNING! TO PREVENT SERIOUS INJURY:** Ensure that the vehicle support points are fully seated in the saddles of both jack stands. Use a matched pair of jack stands per vehicle to support one end only.
8. Place the slotted end of the Jack Handle over the Release Valve and *slowly* turn the Release Valve *counterclockwise* to lower the vehicle onto the saddles of the jack stands.

9. Once the vehicle is fully seated on the jack stands, continue *slowly* lowering the Jack until it is completely lowered, disconnect the air supply and store the Jack according to Maintenance Instructions on page 10.

Lowering a Vehicle

1. Remove all tools, old vehicle parts, etc. from under the vehicle.
2. Turn the Release Valve completely *clockwise* to ensure the Release Valve is closed.
3. **Pneumatic Operation:**
 - a. Release the Air Lever Lock and depress the Air Lever to raise the vehicle slightly above the saddles of the jack stands.
 - b. Place the Air Lever Lock in its *locked* position. Then remove the jack stands from under the vehicle.
4. **Manual Operation:**
 - a. Place the Jack Handle into the Fulcrum.
 - b. Pump Jack Handle to raise the vehicle slightly above the saddles of the jack stands. Then remove the jack stands from under the vehicle.
5. Place the slotted end of the Jack Handle over the Release Valve and *slowly* turn the Release Valve *counterclockwise* to lower the vehicle completely.
6. Disconnect the air supply and store the Jack according to Maintenance Instructions on page 10.

PITTSBURGH[™]

Maintenance Instructions



Procedures not specifically explained in this manual must be performed only by a qualified technician.

WARNING

TO PREVENT SERIOUS INJURY FROM ACCIDENTAL OPERATION:

Turn off the tool, detach the air supply, safely discharge any residual air pressure in the tool, and release the throttle and/or turn the switch to its off position before performing any inspection, maintenance, or cleaning procedures.

TO PREVENT SERIOUS INJURY FROM TOOL FAILURE:

Do not use damaged equipment. If abnormal noise, vibration, or leaking air occurs, have the problem corrected before further use.

Cleaning, Maintenance, and Lubrication

1. **BEFORE EACH USE**, inspect the general condition of the tool. Check for:
 - loose hardware or housing,
 - misalignment or binding of moving parts,
 - damaged air hose,
 - cracked or broken parts, and
 - any other condition that may affect its safe operation.
2. **BEFORE EACH USE**, thoroughly test the Jack for proper operation prior to its actual use. If the Jack appears not to be working properly, follow Bleeding Instructions on page 5.
3. **DAILY - Air Supply Maintenance:**
Every day, maintain the air supply according to the component manufacturers' instructions. Drain the moisture filter regularly. Performing routine air supply maintenance will allow the tool to operate more safely and will also reduce wear on the tool.
4. **AFTER USE**, clean external surfaces of the Jack with a clean, moist cloth and a mild detergent. Do not use solvents.
5. **WHEN STORING**, turn Release Valve *counterclockwise* to its open position. Store the Jack and its accessories in a clean, dry, safe location out of reach of children and other unauthorized people.
6. **ONCE OR TWICE A MONTH**, lubricate the air motor with good quality hydraulic fluid. Add oil through the air valve while holding down the lever.
7. **PERIODICALLY**, check the condition of the hydraulic fluid. Change the hydraulic fluid as needed :
 - a. With the Jack fully lowered, remove the Fill Screw.
 - b. Tip the Jack over to allow the old hydraulic fluid to drain out completely. Dispose of the old hydraulic fluid in accordance with local regulations.
 - c. With the Jack upright, completely fill the Reservoir with high grade hydraulic fluid until the oil is 1/4" below the top of the Fill Port.
 - d. Place the slotted end of the Jack Handle over the Release Valve, then turn *counterclockwise* to open the Release Valve.
 - e. Pump the Handle quickly several times to purge air from the system.
 - f. Recheck fluid level and re-fill as needed.
 - g. Thoroughly bleed jack after changing fluid according to Bleeding Instructions on page 5.

Troubleshooting

⚠️ WARNING

TO PREVENT SERIOUS INJURY AND DEATH:

Use caution when troubleshooting a malfunctioning Jack. Stay well clear of the supported load. Completely resolve all problems before use. If the solutions presented in the Troubleshooting guide do not solve the problem, have a qualified technician inspect and repair the Jack before use.

After the Jack is repaired: Test it carefully without a load by raising and lowering it fully, checking for proper operation, **BEFORE RETURNING THE JACK TO OPERATION.**

DO NOT USE A DAMAGED OR MALFUNCTIONING JACK!

POSSIBLE SYMPTOMS						PROBABLE SOLUTION (Make certain that the jack is not supporting a load while attempting a solution.)
Jack will not lift at its weight capacity	Saddle lowers under load	Pump stroke feels spongy	Saddle will not lift all the way	Handle moves up when jack is under load	Fluid leaking from fill plug	
X	X					Check that Release Valve is fully closed. Bleed air from the system.
X	X			X		Valves may be blocked and may not close fully. To flush the valves: 1. Lower the Saddle and securely close the Release Valve. 2. Manually lift the Saddle several inches. 3. Open the Release Valve and force the Saddle down as quickly as possible.
X		X	X			Jack may be low on fluid. Check the fluid level and refill if needed. Jack may require bleeding - see Bleeding Instructions on page 5.
					X	Unit may have too much hydraulic fluid inside, check fluid level and adjust if needed.



Follow all safety precautions whenever diagnosing or servicing the Jack.

PLEASE READ THE FOLLOWING CAREFULLY

THE MANUFACTURER AND/OR DISTRIBUTOR HAS PROVIDED THE PARTS LIST AND ASSEMBLY DIAGRAM IN THIS MANUAL AS A REFERENCE TOOL ONLY. NEITHER THE MANUFACTURER OR DISTRIBUTOR MAKES ANY REPRESENTATION OR WARRANTY OF ANY KIND TO THE BUYER THAT HE OR SHE IS QUALIFIED TO MAKE ANY REPAIRS TO THE PRODUCT, OR THAT HE OR SHE IS QUALIFIED TO REPLACE ANY PARTS OF THE PRODUCT. IN FACT, THE MANUFACTURER AND/OR DISTRIBUTOR EXPRESSLY STATES THAT ALL REPAIRS AND PARTS REPLACEMENTS SHOULD BE UNDERTAKEN BY CERTIFIED AND LICENSED TECHNICIANS, AND NOT BY THE BUYER. THE BUYER ASSUMES ALL RISK AND LIABILITY ARISING OUT OF HIS OR HER REPAIRS TO THE ORIGINAL PRODUCT OR REPLACEMENT PARTS THERETO, OR ARISING OUT OF HIS OR HER INSTALLATION OF REPLACEMENT PARTS THERETO.

Jack Parts List

Part	Description	Qty
1	Seal Screw	2
2	Copper Pad A	2
3	Spring	2
4	Steel Ball 7.5	2
5	Steel Ball 5.5	5
6	Cap	1
7	Seal Screw	1
8	O-Ring	1
9	Screw	1
10	Spring	1
11	Ball Valve Seat	1
12	Steel Ball 4.0	1
13	Drain Valve	1
14	Ring	1
15	Steel Ball 6.0	1
16	Base	1
17	Block	1
18	Copper Pad B	2
19	Pin	3
20	Bolt	3
21	Connecting Rod	1
22	Pump Body	1
23	Seal	1

Part	Description	Qty
24	Tension Spring	2
25	O-Ring	1
26	Retaining Ring	1
27	Dust Ring	1
28	Cylinder	1
29	Pump Core	1
30	Air Motor	1
31	Air Hose	1
32	Handle Bracket	1
33	Seal	1
34	Outer Housing	1
35	Fill Plug	1
36	O-Ring	1
37	Cup Seal	1
38	Piston Rod	1
39	Seal	1
40	Top Cap	1
41	O-Ring	1
42	Cover	1
43	Front Handle	1
44	Rear Handle	1
45	Strainer	2

Jack Assembly Diagram

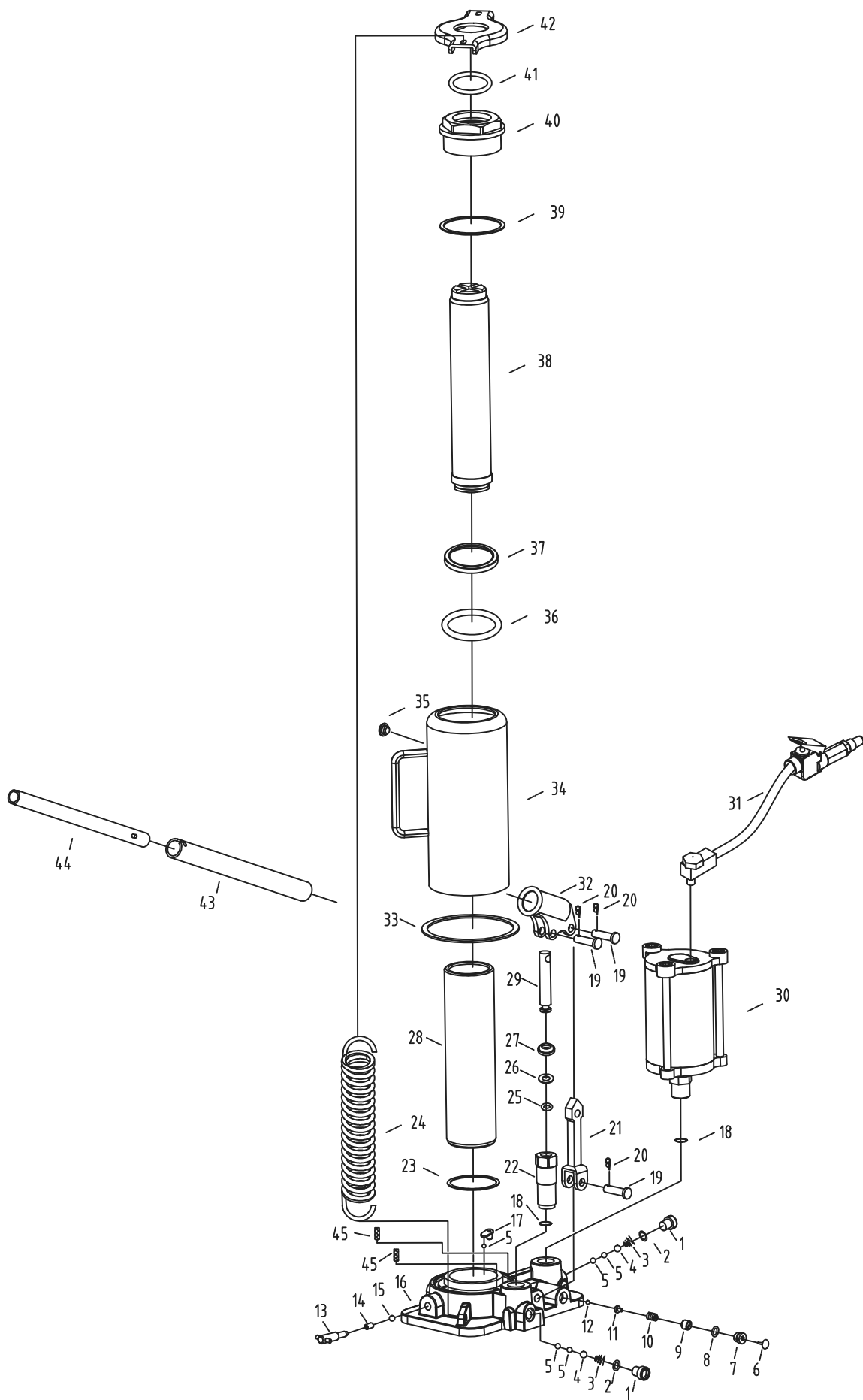

SAFETY

SETUP

OPERATION

MAINTENANCE

Record Product's Serial Number Here: _____

Note: If product has no serial number, record month and year of purchase instead.

Note: Some parts are listed and shown for illustration purposes only, and are not available individually as replacement parts. Parts may not be interchangeable. Specify UPC 193175473806 when ordering parts.

Specify UPC number when ordering:

59425: 193175473806

59426: 193175475695

SAFETY

SETUP

OPERATION

MAINTENANCE

Limited 90 Day Warranty

Harbor Freight Tools Co. makes every effort to assure that its products meet high quality and durability standards, and warrants to the original purchaser that this product is free from defects in materials and workmanship for the period of 90 days from the date of purchase. This warranty does not apply to damage due directly or indirectly, to misuse, abuse, negligence or accidents, repairs or alterations outside our facilities, criminal activity, improper installation, normal wear and tear, or to lack of maintenance. We shall in no event be liable for death, injuries to persons or property, or for incidental, contingent, special or consequential damages arising from the use of our product. Some states do not allow the exclusion or limitation of incidental or consequential damages, so the above limitation of exclusion may not apply to you. THIS WARRANTY IS EXPRESSLY IN LIEU OF ALL OTHER WARRANTIES, EXPRESS OR IMPLIED, INCLUDING THE WARRANTIES OF MERCHANTABILITY AND FITNESS.

To take advantage of this warranty, the product or part must be returned to us with transportation charges prepaid. Proof of purchase date and an explanation of the complaint must accompany the merchandise. If our inspection verifies the defect, we will either repair or replace the product at our election or we may elect to refund the purchase price if we cannot readily and quickly provide you with a replacement. We will return repaired products at our expense, but if we determine there is no defect, or that the defect resulted from causes not within the scope of our warranty, then you must bear the cost of returning the product.

This warranty gives you specific legal rights and you may also have other rights which vary from state to state.

PITTSBURGHTM

26677 Agoura Road • Calabasas, CA 91302 • 1-888-866-5797