

HERCULES®

Owner's Manual & Safety Instructions

**Model
HE41**

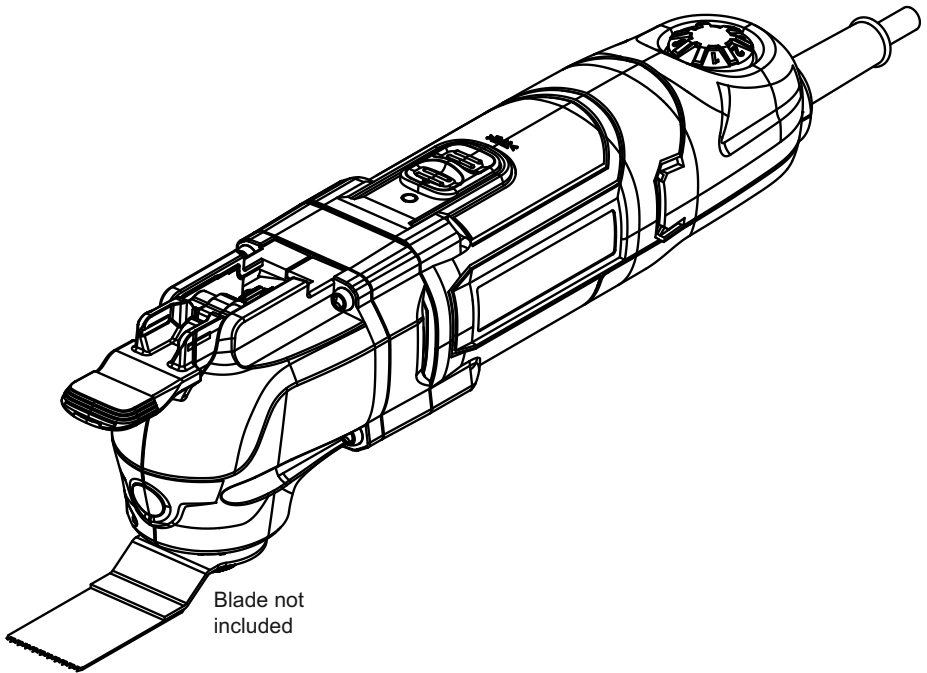

Variable Speed Oscillating Multi-Tool

▲WARNING: To prevent serious injury, User must read and understand Owner's Manual. **SAVE THIS MANUAL.**

When unpacking, make sure that the product is intact and undamaged. If any parts are missing or broken, please call 1-888-866-5797 as soon as possible. Reference 59510.

IMPORTANT SAFETY INFORMATION

GENERAL POWER TOOL SAFETY WARNINGS

⚠️ WARNING

Read all safety warnings and all instructions. Failure to follow the warnings and instructions may result in electric shock, fire and/or serious injury. **Save all warnings and instructions for future reference.** The term "power tool" in the warnings refers to your mains-operated (corded) power tool.

Work Area Safety

- 1. Keep work area clean and well lit.**
Cluttered or dark areas invite accidents.
- 2. Do not operate power tools in explosive atmospheres, such as in the presence of flammable liquids, gases or dust.** *Power tools create sparks which may ignite the dust or fumes.*
- 3. Keep children and bystanders away while operating a power tool.**
Distractions can cause you to lose control.

Electrical Safety

- 1. Power tool plugs must match the outlet. Never modify the plug in any way.** **Do not use any adapter plugs with earthed (grounded) power tools.** *Unmodified plugs and matching outlets will reduce risk of electric shock.*
- 2. Avoid body contact with earthed or grounded surfaces such as pipes, radiators, ranges and refrigerators.** *There is an increased risk of electric shock if your body is earthed or grounded.*
- 3. Do not expose power tools to rain or wet conditions.** *Water entering a power tool will increase the risk of electric shock.*
- 4. Do not abuse the cord. Never use the cord for carrying, pulling or unplugging the power tool. Keep cord away from heat, oil, sharp edges or moving parts.** *Damaged or entangled cords increase the risk of electric shock.*
- 5. When operating a power tool outdoors, use an extension cord suitable for outdoor use.** *Use of a cord suitable for outdoor use reduces the risk of electric shock.*
- 6. If operating a power tool in a damp location is unavoidable, use a Ground Fault Circuit Interrupter (GFCI) protected supply.** *Use of a GFCI reduces the risk of electric shock.*

Personal Safety

- 1. Stay alert, watch what you are doing and use common sense when operating a power tool. Do not use a power tool while you are tired or under the influence of drugs, alcohol or medication.** *A moment of inattention while operating power tools may result in serious personal injury.*
- 2. Use personal protective equipment. Always wear eye protection.** *Protective equipment such as dust mask, non-skid safety shoes, hard hat, or hearing protection used for appropriate conditions will reduce personal injuries.*
- 3. Prevent unintentional starting. Ensure the switch/trigger is in the off-position before connecting to power source and/or battery pack, picking up or carrying the tool.** *Carrying power tools with your finger on the switch or energizing power tools that have the switch on invites accidents.*
- 4. Remove any adjusting key or wrench before turning the power tool on.** *A wrench or a key left attached to a rotating part of the power tool may result in personal injury.*
- 5. Do not overreach. Keep proper footing and balance at all times.** *This enables better control of the power tool in unexpected situations.*
- 6. Dress properly. Do not wear loose clothing or jewelry. Keep your hair, clothing and gloves away from moving parts.** *Loose clothes, jewelry or long hair can be caught in moving parts.*
- 7. If devices are provided for the connection of dust extraction and collection facilities, ensure these are connected and properly used.** *Use of dust collection can reduce dust-related hazards.*
- 8. Do not let familiarity gained from frequent use of tools allow you to become complacent and ignore tool safety principles.** *A careless action can cause severe injury within a fraction of a second.*
- 9. Only use safety equipment that has been approved by an appropriate standards agency.** *Unapproved safety equipment may not provide adequate protection. Eye protection must be ANSI-approved and breathing protection must be NIOSH-approved for the specific hazards in the work area.*
- 10. Avoid unintentional starting.** *Prepare to begin work before turning on the tool.*
- 11. Do not lay the tool down until it has come to a complete stop.** *Moving parts can grab the surface and pull the tool out of your control.*

12. When using a handheld power tool, maintain a firm grip on the tool with both hands to resist starting torque.
13. Do not leave the tool unattended when it is plugged into an electrical outlet. Turn off the tool, and unplug it from its electrical outlet before leaving.
14. This product is not a toy. Keep it out of reach of children.
15. People with pacemakers should consult their physician(s) before use. Electromagnetic fields in close proximity to heart pacemaker could cause pacemaker interference or pacemaker failure. In addition, people with pacemakers should:
 - Avoid operating alone.
 - Do not use with Switch locked on.
 - Properly maintain and inspect to avoid electrical shock.
 - Properly ground power cord.
 Ground Fault Circuit Interrupter (GFCI) should also be implemented – it prevents sustained electrical shock.
16. The warnings, precautions, and instructions discussed in this instruction manual cannot cover all possible conditions and situations that may occur. It must be understood by the operator that common sense and caution are factors which cannot be built into this product, but must be supplied by the operator.

Power Tool Use and Care

1. **Do not force the power tool. Use the correct power tool for your application.** *The correct power tool will do the job better and safer at the rate for which it was designed.*
2. **Do not use the power tool if the Switch does not turn it on and off.** *Any power tool that cannot be controlled with the Switch is dangerous and must be repaired.*
3. **Disconnect the plug from the power source and/or remove the battery pack, if detachable, from the power tool before making any adjustments, changing accessories, or storing power tools.** *Such preventive safety measures reduce the risk of starting the power tool accidentally.*
4. **Store idle power tools out of the reach of children and do not allow persons unfamiliar with the power tool or these instructions to operate the power tool.** *Power tools are dangerous in the hands of untrained users.*
5. **Maintain power tools and accessories. Check for misalignment or binding of moving parts, breakage of parts and any other condition that may affect the power tool's operation. If damaged, have the power tool repaired before use.** *Many accidents are caused by poorly maintained power tools.*

6. **Keep cutting tools sharp and clean.** *Properly maintained cutting tools with sharp cutting edges are less likely to bind and are easier to control.*
7. **Use the power tool, accessories and tool bits etc. in accordance with these instructions, taking into account the working conditions and the work to be performed.** *Use of the power tool for operations different from those intended could result in a hazardous situation.*
8. **Keep handles and grasping surfaces dry, clean and free from oil and grease.** *Slippery handles and grasping surfaces do not allow for safe handling and control of the tool in unexpected situations.*

Service

1. **Have your power tool serviced by a qualified repair person using only identical replacement parts.** *This will ensure that the safety of the power tool is maintained.*
2. Maintain labels and nameplates on the tool. These carry important safety information. If unreadable or missing, contact Harbor Freight Tools for a replacement.

Specific Safety Warnings

Hold the power tool by insulated gripping surfaces, because the sanding surface may contact its own cord. Cutting a "live" wire may make exposed metal parts of the power tool "live" and could give the operator an electric shock.

Vibration Safety

This tool vibrates during use. Repeated or long-term exposure to vibration may cause temporary or permanent physical injury, particularly to the hands, arms and shoulders. To reduce the risk of vibration-related injury:

1. Anyone using vibrating tools regularly or for an extended period should first be examined by a doctor and then have regular medical check-ups to ensure medical problems are not being caused or worsened from use. Pregnant women or people who have impaired blood circulation to the hand, past hand injuries, nervous system disorders, diabetes, or Raynaud's Disease should not use this tool. If you feel any medical or physical symptoms related to vibration (such as tingling, numbness, and white or blue fingers), seek medical advice as soon as possible.
2. Do not smoke during use. Nicotine reduces the blood supply to the hands and fingers, increasing the risk of vibration-related injury.
3. Wear suitable gloves to reduce the vibration effects on the user.
4. Use tools with the lowest vibration when there is a choice between different processes.
5. Include vibration-free periods each day of work.

- Grip tool as lightly as possible (while still keeping safe control of it). Let the tool do the work.
- To reduce vibration, maintain the tool as explained in this manual. If any abnormal vibration occurs, stop use immediately.



SAVE THESE INSTRUCTIONS.

GROUNDING

⚠ WARNING



TO PREVENT ELECTRIC SHOCK AND DEATH FROM INCORRECT GROUNDING: Check with a qualified electrician if you are in doubt as to whether the outlet is properly grounded. Do not modify the power cord plug provided with the tool. Never remove the grounding prong from the plug. Do not use the tool if the power cord or plug is damaged. If damaged, have it repaired by a service facility before use. If the plug will not fit the outlet, have a proper outlet installed by a qualified electrician.

Double Insulated Tools: Tools with Two Prong Plugs

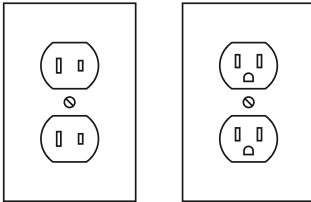

Outlets for 2-Prong Plug

- Tools marked "Double Insulated" do not require grounding. They have a special double insulation system which satisfies OSHA requirements and complies with the applicable standards of Underwriters Laboratories, Inc., the Canadian Standard Association, and the National Electrical Code.
- Double insulated tools may be used in either of the 120 volt outlets shown in the preceding illustration. (See Outlets for 2-Prong Plug.)

Extension Cords









- Grounded** tools require a three wire extension cord. **Double Insulated** tools can use either a two or three wire extension cord.
- As the distance from the supply outlet increases, you must use a heavier gauge extension cord. Using extension cords with inadequately sized wire causes a serious drop in voltage, resulting in loss of power and possible tool damage. (See Table A.)
- The smaller the gauge number of the wire, the greater the capacity of the cord. For example, a 14 gauge cord can carry a higher current than a 16 gauge cord. (See Table A.)
- When using more than one extension cord to make up the total length, make sure each cord contains at least the minimum wire size required. (See Table A.)
- If you are using one extension cord for more than one tool, add the nameplate amperes and use the sum to determine the required minimum cord size. (See Table A.)
- If you are using an extension cord outdoors, make sure it is marked with the suffix "W-A" ("W" in Canada) to indicate it is acceptable for outdoor use.
- Make sure the extension cord is properly wired and in good electrical condition. Always replace a damaged extension cord or have it repaired by a qualified electrician before using it.
- Protect the extension cords from sharp objects, excessive heat, and damp or wet areas.

TABLE A: RECOMMENDED MINIMUM WIRE GAUGE FOR EXTENSION CORDS* (120/240 VOLT)

NAMEPLATE AMPERES (at full load)	EXTENSION CORD LENGTH				
	25'	50'	75'	100'	150'
0 – 2.0	18	18	18	18	16
2.1 – 3.4	18	18	18	16	14
3.5 – 5.0	18	18	16	14	12
5.1 – 7.0	18	16	14	12	12
7.1 – 12.0	18	14	12	10	-
12.1 – 16.0	14	12	10	-	-
16.1 – 20.0	12	10	-	-	-

* Based on limiting the line voltage drop to five volts at 150% of the rated amperes.

Symbology

	Double Insulated
	Volts
	Alternating Current
	Amperes
n ₀ xxxx/min.	No Load Revolutions per Minute (RPM)
	WARNING marking concerning Risk of Eye Injury. Wear ANSI-approved safety goggles with side shields.
	Read the manual before set-up and/or use.
	WARNING marking concerning Risk of Hearing Loss. Wear hearing protection.
	WARNING marking concerning Risk of Fire. Do not cover ventilation ducts. Keep flammable objects away.
	WARNING marking concerning Risk of Electric Shock. Properly connect power cord to appropriate outlet.

Warning Symbols and Definitions

 This is the safety alert symbol. It is used to alert you to potential personal injury hazards. Obey all safety messages that follow this symbol to avoid possible injury or death.

 **DANGER** Indicates a hazardous situation which, if not avoided, will result in death or serious injury.

 **WARNING** Indicates a hazardous situation which, if not avoided, could result in death or serious injury.

 **CAUTION** Indicates a hazardous situation which, if not avoided, could result in minor or moderate injury.

NOTICE Addresses practices not related to personal injury.

Specifications

Electrical Rating	120VAC / 60Hz / 3.5A
No Load Speed	n ₀ :11,000-20,000/min

Functional Description

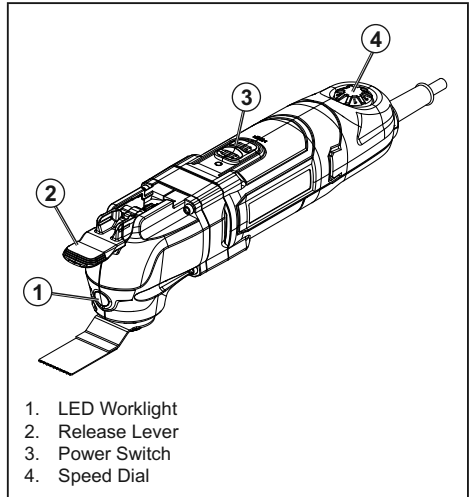

1. LED Worklight
2. Release Lever
3. Power Switch
4. Speed Dial

Workpiece and Work Area Set Up

1. Designate a work area that is clean and well-lit. The work area must not allow access by children or pets to prevent distraction and injury.
2. Route the power cord along a safe route to reach the work area without creating a tripping hazard or exposing the power cord to possible damage. The power cord must reach the work area with enough extra length to allow free movement while working.
3. Secure loose workpieces using a vise or clamps (not included) to prevent movement while working.
4. There must not be hazardous objects, such as utility lines or foreign objects, nearby that will present a hazard while working.
5. You must use personal safety equipment including, but not limited to, ANSI-approved eye and hearing protection, as well as heavy-duty work gloves.

OPERATING INSTRUCTIONS



Read the **ENTIRE IMPORTANT SAFETY INFORMATION** section at the beginning of this manual including all text under subheadings therein before set up or use of this product.

Accessory Installation

⚠️ WARNING

TO PREVENT SERIOUS INJURY FROM ACCIDENTAL OPERATION:

Make sure that the Switch is in the OFF position and unplug the tool from its electrical outlet before performing any procedure in this section.

1. Move the Release Lever forward to the open position and remove the Flange.

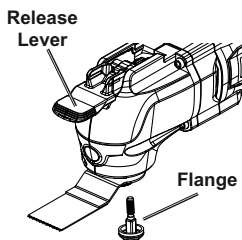

2. Install the desired accessory (sold separately), by lining up accessory's mounting holes with the Spindle's fitting pins.
3. Replace the Flange, tightening snugly.

Note: Most accessories may be installed at angles up to 90° left or right of straight ahead. Cutting Blades should only be used in the straight ahead position.

CAUTION! When attaching the Cutter Blade, orient the accessory so that the blade faces AWAY from the handle to avoid injury.

4. Move the Release Lever back to original position to secure accessory.
5. After securing, the accessory should not move on the Spindle. If it can move with the power off, reinstall it, making sure that the holes on the accessory line up with the fitting pins on the Spindle.

Note: For sanding, first attach the Sanding Pad to the tool, then align a sheet of Sandpaper over the pad and press into place. Once a Sandpaper corner becomes worn, turn it 120° or replace the sheet with a new one.

General Operation

⚠️ WARNING

TO PREVENT SERIOUS INJURY: Grip the tool firmly in both hands.

1. Make sure that the Power Switch is in the off-position, then plug in the tool.
2. Hold the Tool with both hands and slide the Power Switch forward to on-position.
3. Adjust the speed with the Speed Dial. Determine the optimum speed by testing on a scrap piece of material.
4. Do not allow contact between accessory and workpiece until the tool has come up to speed.
5. Avoid contact with foreign objects such as metal screws and nails when sanding, scraping, or cutting.
6. Do not apply excessive pressure on the Tool. Allow the Tool to do the work.
7. When finished, slide the Power Switch to the off-position. Allow the tool to stop completely before setting it down.
8. To prevent accidents, turn off the tool and unplug it after use. Clean, then store the tool indoors out of children's reach.

MAINTENANCE AND SERVICING



Procedures not specifically explained in this manual must be performed only by a qualified technician.

! WARNING

TO PREVENT SERIOUS INJURY FROM ACCIDENTAL OPERATION:

Make sure that the Switch is locked and unplug the tool from its electrical outlet is removed before performing any procedure in this section.

TO PREVENT SERIOUS INJURY FROM TOOL FAILURE:

Do not use damaged equipment.

If abnormal noise or vibration occurs, have the problem corrected before further use.

Cleaning, Maintenance, and Lubrication

- BEFORE EACH USE**, inspect the general condition of the tool. Check for:
 - loose hardware
 - misalignment or binding of moving parts
 - damaged cord/electrical wiring,
 - cracked or broken parts
 - any other condition that may affect its safe operation.
- AFTER USE**, wipe external surfaces of the tool with clean cloth.
- Periodically blow dust and grit out of the motor vents using dry compressed air. Wear ANSI-approved safety goggles and NIOSH-approved breathing protection while doing this.
- ! WARNING! TO PREVENT SERIOUS INJURY: If the supply cord of this power tool is damaged, it must be replaced only by a qualified service technician.**

Troubleshooting

Problem	Possible Causes	Likely Solutions
Tool will not start.	<ol style="list-style-type: none"> Cord not connected. No power at outlet. Tool's thermal reset breaker tripped (if equipped). Internal damage or wear. (Carbon brushes or switch, for example.) 	<ol style="list-style-type: none"> Check that cord is plugged in. Check power at outlet. If outlet is unpowered, turn off tool and check circuit breaker. If breaker is tripped, make sure circuit is right capacity for tool and circuit has no other loads. Turn off tool and allow to cool. Press reset button on tool. Have technician service tool.
Tool operates slowly.	<ol style="list-style-type: none"> Excess pressure applied to workpiece. Forcing tool to work too fast. Extension cord too long or cord diameter too small. Power being reduced by long or small diameter extension cord. 	<ol style="list-style-type: none"> Decrease pressure, allow tool to do the work. Allow tool to work at its own rate. Eliminate use of extension cord. If an extension cord is needed, use one with the proper diameter for its length and load. See <i>Extension Cords</i> in <i>Grounding</i> section on page <HT>. Eliminate use of extension cord. If an extension cord is needed, use one with the proper diameter for its length and load. See <i>Extension Cords</i> in <i>GROUNDING</i> section.
Performance decreases over time.	Carbon brushes worn or damaged.	Have qualified technician replace brushes.
Excessive noise or rattling.	Internal damage or wear. (Carbon brushes or bearings, for example.)	Have technician service tool.
Overheating.	<ol style="list-style-type: none"> Forcing tool to work too fast. Blocked motor housing vents. Motor being strained by long or small diameter extension cord. 	<ol style="list-style-type: none"> Allow tool to work at its own rate. Wear ANSI-approved safety goggles and NIOSH-approved dust mask/respirator while blowing dust out of motor using compressed air. Eliminate use of extension cord. If an extension cord is needed, use one with the proper diameter for its length and load. See <i>Extension Cords</i> in <i>GROUNDING</i> section.



Follow all safety precautions whenever diagnosing or servicing the tool. Disconnect power supply before service.

LIMITED 90 DAY WARRANTY

Harbor Freight Tools Co. makes every effort to assure that its products meet high quality and durability standards, and warrants to the original purchaser that this product is free from defects in materials and workmanship for the period of 90 days from the date of purchase. This warranty does not apply to damage due directly or indirectly, to misuse, abuse, negligence or accidents, repairs or alterations outside our facilities, criminal activity, improper installation, normal wear and tear, or to lack of maintenance. We shall in no event be liable for death, injuries to persons or property, or for incidental, contingent, special or consequential damages arising from the use of our product. Some states do not allow the exclusion or limitation of incidental or consequential damages, so the above limitation of exclusion may not apply to you. THIS WARRANTY IS EXPRESSLY IN LIEU OF ALL OTHER WARRANTIES, EXPRESS OR IMPLIED, INCLUDING THE WARRANTIES OF MERCHANTABILITY AND FITNESS.

To take advantage of this warranty, the product or part must be returned to us with transportation charges prepaid. Proof of purchase date and an explanation of the complaint must accompany the merchandise. If our inspection verifies the defect, we will either repair or replace the product at our election or we may elect to refund the purchase price if we cannot readily and quickly provide you with a replacement. We will return repaired products at our expense, but if we determine there is no defect, or that the defect resulted from causes not within the scope of our warranty, then you must bear the cost of returning the product.

This warranty gives you specific legal rights and you may also have other rights which vary from state to state.

Record Product's Serial Number Here: _____

Note: If product has no serial number, record month and year of purchase instead.

Note: Replacement parts are not available. Refer to UPC 193175473134.

Visit our website at: <http://www.harborfreight.com>

Email our technical support at: productsupport@harborfreight.com

For technical questions, please call 1-888-866-5797

Copyright© 2021 by Harbor Freight Tools®. All rights reserved. No portion of this manual or any artwork contained herein may be reproduced in any shape or form without the express written consent of Harbor Freight Tools. Diagrams within this manual may not be drawn proportionally. Due to continuing improvements, actual product may differ slightly from the product described herein. Tools required for assembly and service may not be included.

HERCULES®

26677 Agoura Road • Calabasas, CA 91302 • 1-888-866-5797