

# Owner's Manual & Safety Instructions

**Save This Manual** Keep this manual for the safety warnings and precautions, assembly, operating, inspection, maintenance and cleaning procedures. Write the product's serial number in the back of the manual near the assembly diagram (or month and year of purchase if product has no number). Keep this manual and the receipt in a safe and dry place for future reference.

221



## 5HP 2-STAGE V-STYLE CAST IRON PUMP



### ⚠ WARNING



**To prevent serious injury and death from improper installation:** ONLY a qualified engineer with appropriate certifications may attempt designing a new compressor to ensure that all required safety and control elements are in place and will work together properly and safely. This compressor pump is intended ONLY as a replacement for a similarly rated pump on an existing compressor that includes all other needed components. Constructing a new compressor using this pump is not covered by the manual.

Visit our website at: <http://www.harborfreight.com>  
Email our technical support at: [productsupport@harborfreight.com](mailto:productsupport@harborfreight.com)

59672

When unpacking, make sure that the product is intact and undamaged. If any parts are missing or broken, please call 1-888-866-5797 as soon as possible.

Copyright© 2022 by Harbor Freight Tools®. All rights reserved.  
No portion of this manual or any artwork contained herein may be reproduced in any shape or form without the express written consent of Harbor Freight Tools. Diagrams within this manual may not be drawn proportionally. Due to continuing improvements, actual product may differ slightly from the product described herein.  
Tools required for assembly and service may not be included.

### ⚠ WARNING

Read this material before using this product. Failure to do so can result in serious injury.  
**SAVE THIS MANUAL.**

# Table of Contents

Safety .....	2	Maintenance and Servicing .....	11
Specifications .....	5	Parts List and Diagram .....	14
Installation .....	6	Warranty .....	16

SAFETY



INSTALLATION

## WARNING SYMBOLS AND DEFINITIONS

	This is the safety alert symbol. It is used to alert you to potential personal injury hazards. Obey all safety messages that follow this symbol to avoid possible injury or death.
	Indicates a hazardous situation which, if not avoided, will result in death or serious injury.
	Indicates a hazardous situation which, if not avoided, could result in death or serious injury.
	Indicates a hazardous situation which, if not avoided, could result in minor or moderate injury.
	Addresses practices not related to personal injury.

MAINTENANCE

## IMPORTANT SAFETY INFORMATION

### General Safety Warnings



**WARNING** Read all safety warnings and instructions.

*Failure to follow the warnings and instructions may result in electric shock, fire and/or serious injury.*

**Save all warnings and instructions for future reference.**

The warnings, precautions, and instructions discussed in this instruction manual cannot cover all possible conditions and situations that may occur. It must be understood by the operator that common sense and caution are factors which cannot be built into this product, but must be supplied by the operator.

#### 1. Work area safety

- Keep work area clean and well lit.**  
Cluttered or dark areas invite accidents.
- Do not operate the Compressor Pump in explosive atmospheres, such as in the presence of flammable liquids, gases or dust.**  
Compressor pump motors produce sparks which may ignite the dust or fumes.
- Keep children and bystanders away from an operating compressor pump.**

#### 2. Personal safety

- Stay alert, watch what you are doing and use common sense when operating this compressor pump. Do not use this compressor pump while you are tired or under the influence of drugs, alcohol or medication.** A moment of inattention while operating a compressor pump may result in serious personal injury.
- Use personal protective equipment. Always wear ANSI-approved eye protection during setup and use.**

PARTS LIST

3. **Compressor Pump use and care**
  - a. **Disconnect the plug of the compressor motor from the power source before installing, making any adjustments, changing accessories, or storing the Compressor Pump.** Such preventive safety measures reduce the risk of starting the unit accidentally.
  - b. **Store an idle compressor pump out of the reach of children and do not allow persons unfamiliar with the compressor pump or these instructions to operate it.** A compressor pump is dangerous in the hands of untrained users.
  - c. **Maintain the Compressor Pump. Keep the Compressor Pump clean for better and safer performance. Follow instructions for lubricating and changing accessories. Keep dry, clean and free from oil and grease. Check for misalignment or binding of moving parts, breakage of parts and any other condition that may affect the compressor's operation. If damaged, have the compressor repaired before use.** Many accidents are caused by a poorly maintained compressor pump.
  - d. **Use the Compressor Pump in accordance with these instructions, taking into account the working conditions and the work to be performed.** Use of the Compressor Pump for operations different from those intended could result in a hazardous situation.
4. **Service**
  - a. **Have the Compressor Pump serviced by a qualified repair person using only identical replacement parts.** This will ensure that the safety of the Compressor Pump is maintained.

## Compressor Pump Safety Warnings

1. **ONLY a qualified engineer with appropriate certifications may attempt designing a new compressor to ensure that all required safety and control elements are in place and will work together properly and safely. This compressor pump is intended ONLY as a replacement for a similarly rated pump on an existing compressor that includes all other needed components. Constructing a new compressor using this pump is not covered by this manual.**
2. **Use Safety Guard for Pulleys.** The Air Compressor Pump Pulley, belts (not included), and motor pulley (not included) must be covered by a safety guard (not included) covering all moving elements before operation.
3. **Before first and every use, verify Pump has sufficient oil.**
4. The use of accessories or attachments not recommended by the manufacturer may result in a risk of injury to persons.
5. **Misalignment between Motor and Pump can damage the Pump Pulley.** Use a straight edge, such as a yardstick, to check and adjust alignment as needed.
6. **Use proper size motor and motor pulley.** This Air Compressor Pump must be installed with a 5 HP electric motor and pulley (both not included) which can turn the Air Compressor Pump Pulley at approximately 1180 RPM.
7. **Install motor, pulley belts and pulley belt cover securely.** Be sure to use the proper size bolts to install the motor (not included). The belts and belt cover (not included) must be strong enough to prevent breaking and possible injury.
8. **Be sure all equipment is rated to the appropriate capacity of this pump.** Make sure that the lowest rated piece of equipment being used can handle the maximum pressure of the Air Compressor Pump (see Specifications).
9. **Do not direct the air stream at any person or animal.**
10. **Avoid burns.** The Cylinders, Cylinder Heads, and Air Outlet components become very hot during operation. Do not touch.
11. Industrial applications must follow OSHA guidelines.
12. Maintain labels and nameplates on the Compressor Pump. These carry important safety information. If unreadable or missing, contact Harbor Freight Tools for a replacement.
13. This product is not a toy. Keep it out of reach of children.

# Air Compressor Safety Warnings

SAFETY

INSTALLATION

MAINTENANCE

PARTS LIST

1. **Risk of fire or explosion - do not spray flammable liquid in a confined area or towards a hot surface. Spray area must be well-ventilated. Do not smoke while spraying or spray where spark or flame is present. Arcing parts - keep compressor at least 20 feet away from explosive vapors, such as when spraying with a spray gun.**
2. **Risk of bursting - do not adjust regulator higher than marked maximum pressure of attachment.**
3. **Risk of injury - do not direct air stream at people or animals.**
4. **Do not use to supply breathing air.**
5. **Do not leave compressor unattended for an extended period while plugged in. Unplug compressor after working.**
6. **Keep compressor well-ventilated. Do not cover compressor during use.**
7. Drain tank daily and after use. Internal rust causes tank failure and explosion.
8. Add correct amount of compressor oil before first use and every use. Operating with low or no oil causes permanent damage and voids warranty.
9. Do not remove the valve cover or adjust internal components.
10. Compressor head gets hot during operation. Do not touch it or allow children nearby during or immediately following operation.
11. Do not use the air hose to move the compressor.
12. Release the pressure in the storage tank before moving.
13. The use of accessories or attachments not recommended by the manufacturer may result in a risk of injury to persons.
14. All air line components, including hoses, pipe, connectors, filters, etc., must be rated for a minimum working pressure of 150 PSI, or 150% of the maximum system pressure, whichever is greater.
15. **USE OF AN EXTENSION CORD IS NOT RECOMMENDED.** If you choose to use an extension cord, use the following guidelines:
 

TABLE A: RECOMMENDED MINIMUM WIRE GAUGE FOR EXTENSION CORDS (120 VOLT)				
NAMEPLATE AMPERES (at full load)	EXTENSION CORD LENGTH			
	25'	50'	100'	150'
0 – 6	18	16	16	14
6.1 – 10	18	16	<b>Do not use.</b>	
10.1 – 12	16	16	<b>Do not use.</b>	
12.1 – 16	14	12	<b>Do not use.</b>	

  - a. Make sure your extension cord is in good condition.
  - b. Be sure to use an extension cord which is heavy enough to carry the current your product will draw. An undersized cord will cause a drop in line voltage resulting in loss of power and overheating. Table A shows the correct size to use depending on cord length and nameplate ampere rating. If in doubt, use the next heavier gauge. The smaller the gauge number, the heavier the cord.
16. Operate unit on level surface. Check oil level daily and fill to marked level if needed.
17. People with pacemakers should consult their physician(s) before use. Electromagnetic fields in close proximity to heart pacemaker could cause pacemaker interference or pacemaker failure.



**SAVE THESE INSTRUCTIONS.**

## Grounding

### ⚠️ WARNING





**TO PREVENT ELECTRIC SHOCK AND DEATH FROM INCORRECT GROUNDING WIRE CONNECTION:**

Check with a qualified electrician if you are in doubt as to whether the outlet is properly grounded. Do not modify the power cord plug provided with any motor used with this Compressor Pump. Never remove the grounding prong from the plug. Do not use the motor if the power cord or plug is damaged. If damaged, have it repaired by a service facility before use. If the plug will not fit the outlet, have a proper outlet installed by a qualified electrician.

## Symbology

<b>PSI</b>	Pounds per square inch of pressure
<b>CFM</b>	Cubic Feet per Minute flow
<b>SCFM</b>	Cubic Feet per Minute flow at standard conditions
<b>NPT</b>	National pipe thread, tapered
<b>NPS</b>	National pipe thread, straight

	Double Insulated
<b>V</b>	Volts
	Alternating Current
<b>A</b>	Amperes

## Specifications

Type	Two Stage Twin Cylinder; Oil Lubricated
Required HP	5 HP motor
Max. Working Pressure	175 PSI
Speed Range	850 - 1180 RPM
Recommended Speed	1180 RPM
Air Outlet	1/2" – NPT
Air Delivery @ 1180 RPM	15.0 SCFM @ 90 PSI
Lubrication	Splash Type with Oil Level Window
Oil Type	SAE 30W ISO100 non-detergent Air Compressor Oil (Sold separately)
Pump Pulley	16-1/2" diameter with single V-groove
Belt Type	B-Width, V-Style
Mounting Hole Pattern	5-1/4" x 10-1/4" (center-to-center) Four 7/16" diameter holes
Recommended Mounting Bolts	3/8" diameter, grade 5 or better
Overall Dimensions	18" L x 13-3/4" W x 18-3/4" H
Sound Level	86.5 dba

## Installation



Read the **ENTIRE IMPORTANT SAFETY INFORMATION** section at the beginning of this manual including all text under subheadings therein before set up or use of this product.

### ⚠️ WARNING

**TO PREVENT SERIOUS INJURY FROM ACCIDENTAL OPERATION:**  
Turn the power switch “OFF” and unplug the motor from its electrical outlet before assembling or making any adjustments to the Compressor Pump.

### ⚠️ WARNING



**TO PREVENT SERIOUS INJURY AND DEATH FROM IMPROPER INSTALLATION:**  
**ONLY** a qualified engineer with appropriate certifications may attempt designing a new compressor to ensure that all required safety and control elements are in place and will work together properly and safely. This compressor pump is intended **ONLY** as a replacement for a similarly rated pump on an existing compressor that includes all other needed components. Constructing a new compressor using this pump is not covered by this manual.

**Note:** For additional information regarding the parts listed in the following pages, refer to the Assembly Diagram near the end of this manual.

## Components

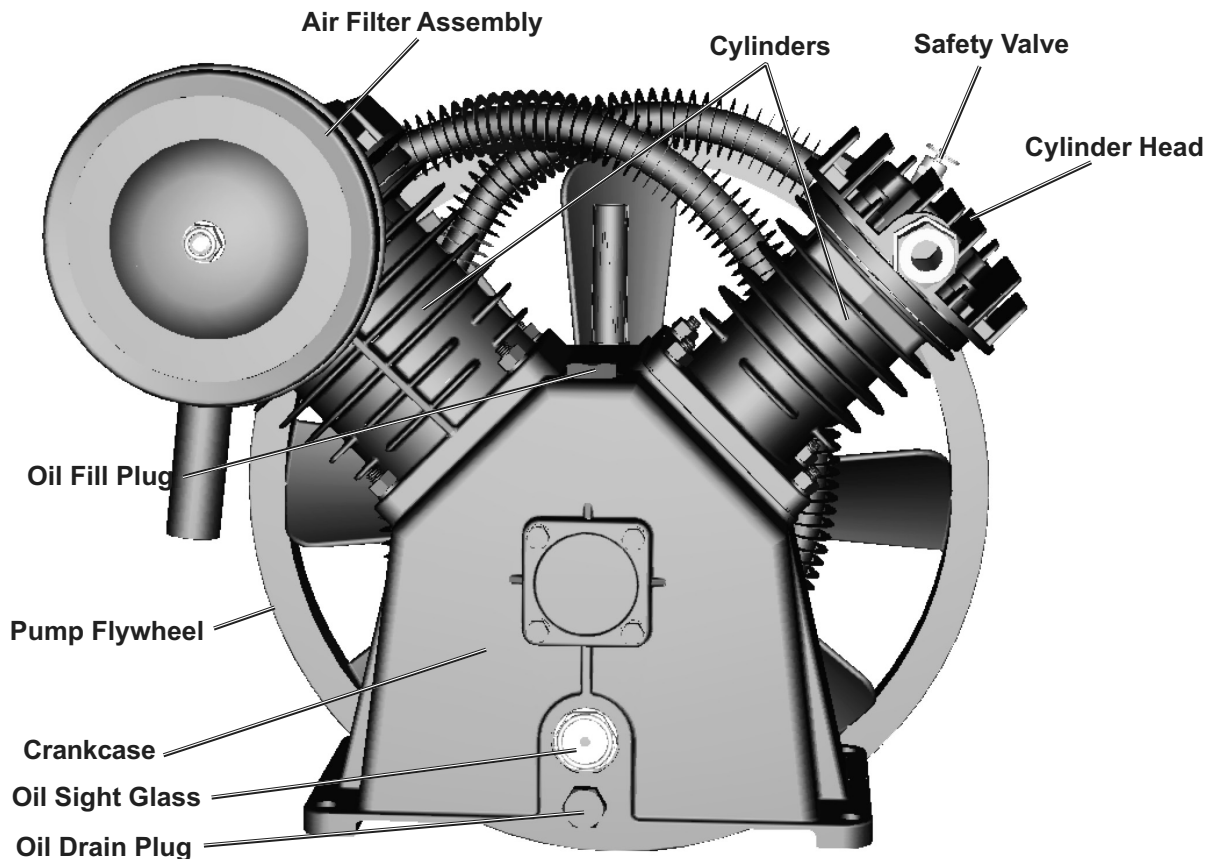

# Assembly

1. Make sure that the center hole and the keyway on the Flywheel (70) are free of burrs and rough edges.
2. Place a small amount of grease in the slot at the tapered end of the Crankshaft (61) and insert the Woodruff Key (71) into the slot.
3. Apply a thin layer of grease to the hole and keyway. With the indented side of the Flywheel center facing out, align the keyway with the Woodruff Key and slide the Flywheel over the Crankshaft. Flywheel should be installed for counterclockwise rotation when facing the pulley side of the Pump.

**Warning!** Do not force or hammer the Pump Flywheel onto the Crankshaft.

4. Slide the Flywheel Washer (72) onto Bolt (73) and insert Bolt through Flywheel and thread COUNTERCLOCKWISE into the Crankshaft. Tighten using wrench (not included).

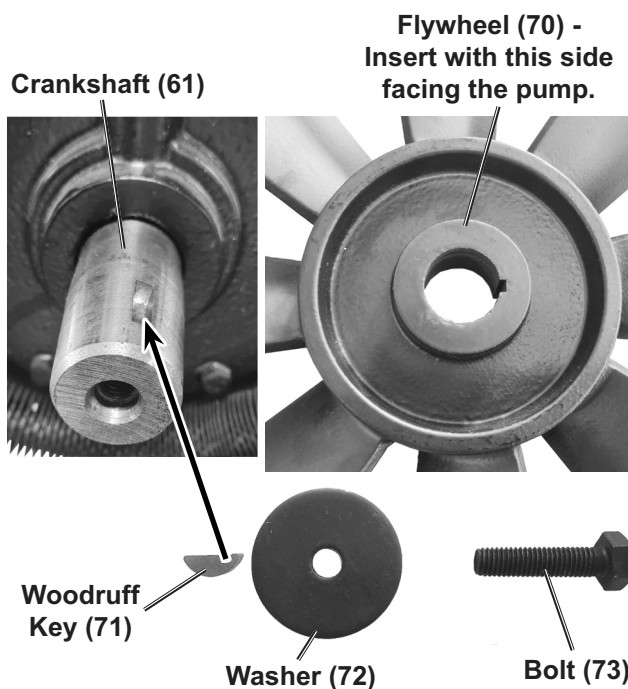

# Installation

**Note:** Depending on your level of expertise, you may wish to have a qualified technician perform this installation.

**NOTICE:** Avoid damage to the Air Compressor Pump and other equipment. The Compressor Pump mounting platform should be flat, level, and strong enough to support the combined weight of the Pump, electric motor or engine, and related hardware and equipment. It must also be capable of withstanding the vibration and tension of the drive belt.

1. Place Air Compressor Pump on mounting surface at same level as 5HP motor used to drive it. Pump positioning must incorporate easy access to Oil Drain Plug (2).
2. Use a motor (not included) with appropriate sized pulley to achieve the target RPM (1180 RPM).

**Note:** Recommended pulley size is 5.6". To calculate needed pulley diameter, multiply Flywheel (70) Diameter (16.5") by Pump RPM (1180). Divide this number by motor RPM to get the necessary motor pulley size. Use the pulley size closest to this figure.

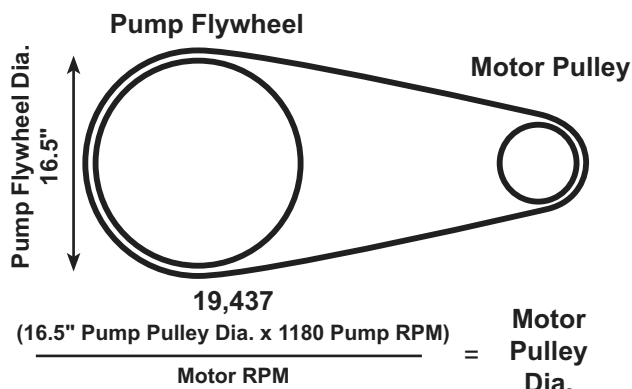

3. The Flywheel must be in perfect alignment with the motor pulley (not included). Misalignment between the Motor and the Compressor Pump can cause damage to both the motor and the compressor pump. Use a straight edge, such as a yardstick, to check and adjust alignment as needed.

**Note:** Ensure the Flywheel is installed for counterclockwise rotation when facing the Flywheel side of the Pump.

4. Verify that Flywheel turns freely where it overhangs the mounting surface.
5. Place an A-width, V-style Belt (not included) over Flywheel and motor pulley (not included).
6. Pull Compressor Pump until properly aligned, and the belt is tight. Recheck alignment of motor pulley, belt, and Flywheel alignment.
7. To mount Compressor Pump:
  - a. Use mounting holes in Compressor Pump Base as a template to mark spots where four holes will be drilled into mounting surface.
  - b. Move Compressor Pump aside, and drill four 7/16" diameter holes in the mounting surface.
  - c. Move Compressor Pump back to mounting position and secure each corner of the base with a 3/8" diameter Grade 5 (or better) bolt, washer, lock washer, and nut (all not included).
  - d. Recheck Pump, belt, and pulley alignment. Make adjustments as necessary. To test proper tension on belt, press down on belt. There should be 1/2" deflection or less at mid span.
  - e. Tighten all mounting hardware.

8. Connect plumbing hardware (not included) from the 3/4"-NPT Air Outlet to Air Destination (i.e., air pressure tank of compressor, not included). Route tubing in shortest possible path.
9. Depending on the air tool, you may need to incorporate additional components, such as in-line oiler, filter, or dryer (all sold separately), as shown in Figure A on page 9 and Figure B on page 10. Consult your air tool's manual for needed accessories.
10. Install safety guard (not included) that surrounds motor pulley, belt, and Pump Flywheel. Safety guard should cover all sides of moving belt and pulleys. Safety guard must have one inch clearance from all moving parts and should be sturdy enough to prevent injury.

**WARNING! TO PREVENT SERIOUS INJURY: Do not operate an Air Compressor Pump without a safety guard in place.**

11. To operate, fill the Compressor Pump Crankcase with Air Compressor Oil (sold separately) following the directions in the next section. Then follow the manufacturer's operating instructions and safety warnings applicable to your air compressor.

## Checking Oil Level

1. Check oil level before operating Air Compressor Pump.
4. To add oil:

**IMPORTANT: Running an Air Compressor Pump with no oil or low oil will cause damage to the equipment and void the warranty.**

2. Fill Pump Crankcase with SAE 30W, non-detergent, Air Compressor Oil (sold separately).
3. Oil level should be at the center of the FULL level on the Oil Sight Glass (4). Add oil as needed to maintain this level. Do not let oil level go below center circle (LOW) and do not fill oil above center circle (OVERFILL).

- a. Remove the Oil Fill Plug (10).
- b. Using a funnel to avoid spills, pour enough oil into the Pump Crankcase to reach the "full" level in the Oil Sight Glass.
- c. Replace the Oil Fill Plug.

**Note:** SAE 30W, non-detergent, Air Compressor Oil (sold separately) is recommended for use with this compressor.

5. If uncertain which oil to use for this compressor, call Harbor Freight Tools customer service at 1-888-866-5797 for assistance.

6. **Change the compressor oil after the first hour of use to remove any debris.**

**CAUTION! TO PREVENT INJURY FROM BURNS: Do not add or change the oil while a compressor is in operation. Allow the compressor to cool before replacing oil.**

**Note:** This pump will consume oil during operation, so check oil level before every use.

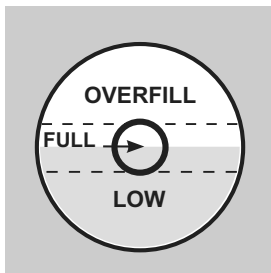
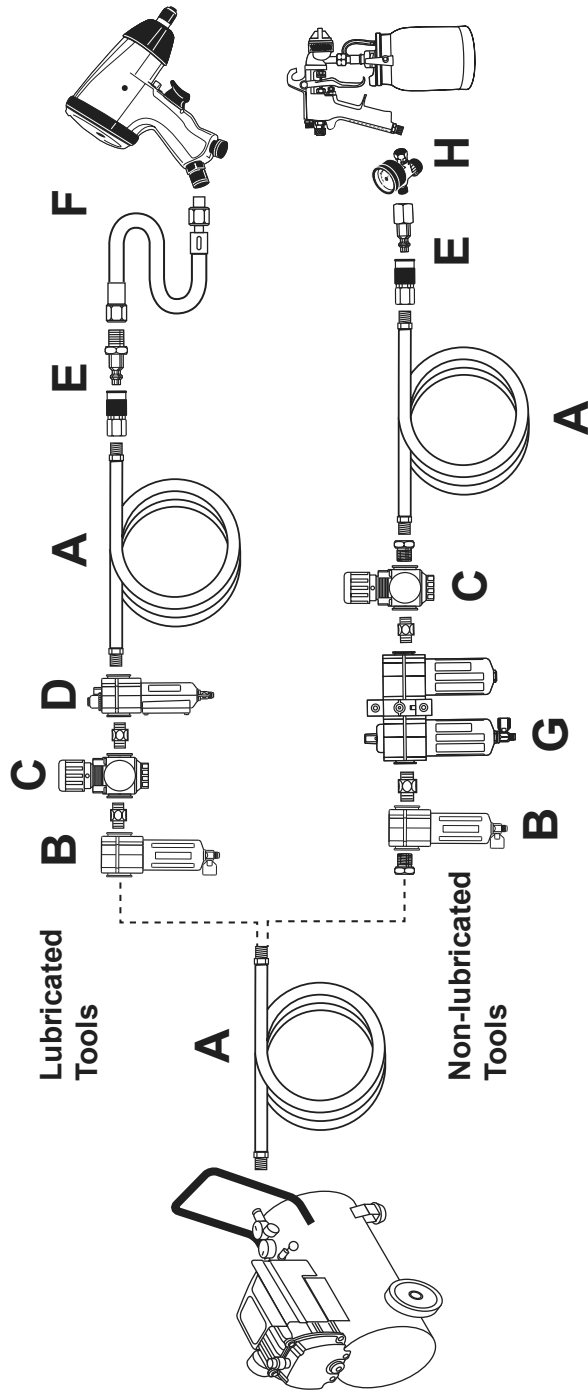

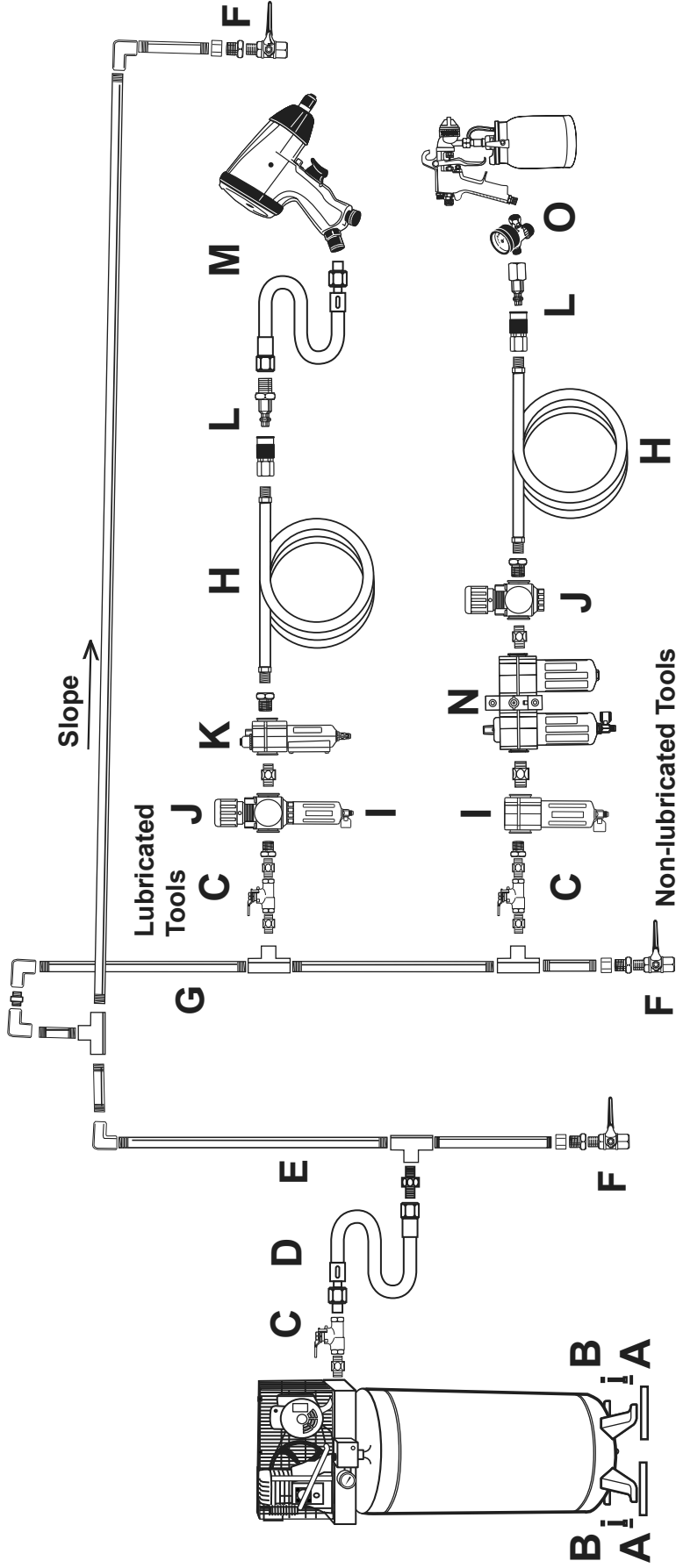

Figure A: Portable Air Supply Setup



	Description	Function
A	Air Hose	Connects air to tool
B	Filter	Prevents dirt and condensation from damaging tool or workpiece
C	Regulator	Adjusts air pressure to tool
D	Lubricator (optional)	For air tool lubrication
E	Coupler and Plug	Provides quick connection and release
F	Leader Hose (optional)	Increases coupler life
G	Air Cleaner / Dryer (optional)	Prevents water vapor from damaging workpiece
H	Air Adjusting Valve (optional)	For fine tuning airflow at tool

Figure B: Stationary Air Supply Setup



Description	Function
A Vibration Pads	For noise and vibration reduction
B Anchor Bolts	Secures air compressor in place
C Ball Valve	Isolates sections of system for maintenance
D Isolation Hose	For vibration reduction
E Main Air Line - 3/4" minimum recommended	Distributes air to branch lines
F Ball Valve	To drain moisture from system
G Branch Air Line - 1/2" minimum recommended	Brings air to point of use
H Air Hose	Connects air to tool
I Filter	Prevents dirt and condensation from damaging tool or workpiece
J Regulator	Adjusts air pressure to tool
K Lubricator (optional)	For air tool lubrication
L Coupler and Plug	Provides quick connection and release
M Leader Hose (optional)	Increases coupler life
N Air Cleaner / Dryer (optional)	Prevents water vapor from damaging workpiece
O Air Adjusting Valve (optional)	For fine tuning airflow at tool

## Maintenance and Servicing



Procedures not specifically explained in this manual must be performed only by a qualified technician.

### **⚠️ WARNING**

#### **TO PREVENT SERIOUS INJURY FROM ACCIDENTAL OPERATION:**

Turn the Power Switch “OFF” and unplug the Compressor from its electrical outlet before performing any inspection, maintenance, or cleaning procedures.

#### **TO PREVENT SERIOUS INJURY FROM COMPRESSOR FAILURE:**

Do not use damaged equipment. If abnormal noise or vibration occurs, have the problem corrected before further use.

## Cleaning, Maintenance, and Lubrication

- BEFORE EACH USE**, inspect the general condition of the air compressor. Check for:
  - **low oil level**
  - loose hardware,
  - misalignment or binding of moving parts,
  - cracked or broken parts,
  - damaged electrical wiring, and
  - any other condition that may affect its safe operation.
- AFTER USE**, wipe external surfaces of the compressor with a clean cloth.
- ⚠️ WARNING!** If the supply cord of a compressor is damaged, it must be replaced only by a qualified service technician.

## Maintenance Schedule

Following are general guidelines for maintenance checks of the Air Compressor Pump.

**Note:** The environment in which the Compressor Pump is used, and the frequency of use can affect how often you will need to check the Pump components and perform maintenance procedures.

### Daily:

- Check oil level.
- Check for oil leaks.
- Make sure all nuts and bolts are tight.
- Check for abnormal noise or vibration.
- Check for air leaks.\*
- Inspect belts.
- Wipe off any oil or dirt from the Compressor Pump.\*\*

### Weekly:

- Inspect Air Filter.
- Inspect Oil Breather.

### Monthly:

- Check Belt Adjustments.

### Every 6 months or 100 Operation Hours:

Replace Pump oil.\*\*\*

\* To check for air leaks, apply soapy water to joints while the Air Compressor is pressurized. Look for air bubbles.

\*\* To clean the Compressor Pump surface, wipe with a damp cloth, using a mild detergent or mild solvent.

\*\*\* Use SAE 30W, non-detergent, Air Compressor Oil only (sold separately).

## Oil Maintenance

Check the oil periodically for clarity. Replace oil if it appears milky or if debris is present, or every 6 months, or 100 operation hours, whichever comes first.

Replace the oil more frequently if compressor is used in harsh environments such as high heat or high humidity.

### **CAUTION! TO PREVENT INJURY FROM BURNS:**

**Allow an Air Compressor to cool before changing the oil.**

1. Place a container under the Oil Drain Plug.
2. Remove the Oil Fill Plug to allow air flow into the Pump.
3. Remove the Oil Drain Plug, allowing the oil to drain into the container.
4. When the oil is completely drained from the Pump, replace the Oil Drain Plug.
5. Fill the Pump with new SAE 30W, non-detergent, Air Compressor Oil to the FULL level on the Oil Sight Glass.
6. Replace and tighten the Oil Fill Plug.
7. Discard the old oil according to local, state and federal regulations.

## Air Filter Maintenance

Check the Air Filter weekly to see if it needs replacement.

Replace the filter more often if Compressor is used in dirty environments.

1. Remove Air Filter Front Cover.
2. Remove the Air Filter.
3. Check Filter for accumulated dirt.
4. Clean the Air Filter:
  - a. **Paper Filters:** To prevent injury from dust and debris, wear ANSI-approved safety goggles, NIOSH-approved dust mask/respirator, and heavy-duty work gloves. In a well-ventilated area away from bystanders, use pressurized air (no more than 15 PSI) to blow dust out of the filter.
  - b. **Foam Filters:** Wash the filter in warm water and mild detergent several times. Rinse. Squeeze out excess water and allow it to dry completely. Soak the filter in lightweight oil briefly, then squeeze out the excess oil.
5. Replace Air Filter. Replace with new Air Filter as needed.
6. Replace the cover.

## Adjusting Belt Tension

1. Remove the Belt Guard and set it aside.
2. Press on the center of the longest span of the belt with moderate finger pressure (4–4.5 lb.). Then measure the deflection distance, the distance that the belt moved. The belt should deflect anywhere from 1/2" to 1".
3. **If the belt deflects too much**, tighten belt by loosening the four Bolts holding motor in place and moving the motor away from the other pulley slightly. Secure motor mounting bolts and retest tension. If belt is too long to be properly tensioned, it must be replaced.
4. **If the belt deflects too little**, loosen belt by loosening the Bolts holding motor in place and moving the motor and moving the motor towards the other pulley slightly. Secure motor mounting bolts and retest tension.
5. Before use, replace Belt Guard.

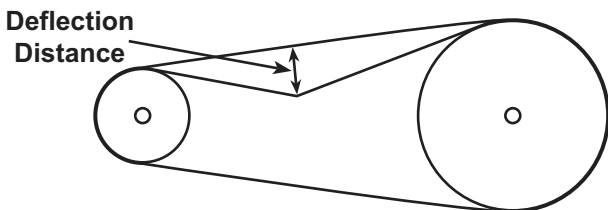

# Troubleshooting

Problem	Possible Causes	Likely Solutions
Compressor builds pressure too slowly	<ol style="list-style-type: none"> <li>1. Crankcase oil overfilled or oil too thick.</li> <li>2. Working environment too cold.</li> <li>3. Loose fittings.</li> </ol>	<ol style="list-style-type: none"> <li>1. Drain oil and refill to proper level with recommended oil. Check that recommended oil is in crankcase.</li> <li>2. Move compressor to a warmer location.</li> <li>3. Reduce air pressure, then check all fittings with a soap solution for air leaks and tighten as needed. Do not overtighten.</li> </ol>
Compressor not building enough air pressure	<ol style="list-style-type: none"> <li>1. Air filters need cleaning/replacing.</li> <li>2. Compressor not large enough for job.</li> <li>3. Loose fittings.</li> <li>4. Hose or hose connections too narrow.</li> <li>5. Crankcase oil too thick.</li> <li>6. High altitude reducing air output.</li> </ol>	<ol style="list-style-type: none"> <li>1. Check inlet and outlet filters. Clean and/or replace as needed.</li> <li>2. Check if accessory CFM is met by Compressor. If Compressor cannot supply enough air flow (CFM), you need a larger Compressor.</li> <li>3. Reduce air pressure, then check all fittings with a soap solution for air leaks and tighten as needed. Do not overtighten.</li> <li>4. Replace with wider hose and/or hose connections.</li> <li>5. Drain oil and refill to proper level with recommended oil.</li> <li>6. Higher altitudes require compressors with greater output.</li> </ol>
Overheating	<ol style="list-style-type: none"> <li>1. Air filters need cleaning/replacing.</li> <li>2. Crankcase oil too thin or incorrect type.</li> <li>3. Crankcase oil level too low.</li> <li>4. Unusually dusty environment.</li> <li>5. Unit not on level surface.</li> </ol>	<ol style="list-style-type: none"> <li>1. Check inlet and outlet filters. Clean and/or replace as needed.</li> <li>2. Drain oil and refill to proper level with recommended oil.</li> <li>3. Add oil to proper level, check for leaks.</li> <li>4. Clean and/or replace filters more often or move unit to cleaner environment.</li> <li>5. Reposition unit on a level surface.</li> </ol>
Excessive noise	<ol style="list-style-type: none"> <li>1. Loose fittings.</li> <li>2. Loose or damaged belt guard.</li> <li>3. Crankcase overfilled with oil or oil is incorrect thickness or type.</li> <li>4. Crankcase oil level too low.</li> <li>5. Unit not on level surface.</li> </ol>	<ol style="list-style-type: none"> <li>1. Reduce air pressure, then check all fittings with a soap solution for air leaks and tighten as needed. Do not overtighten.</li> <li>2. Replace belt guard.</li> <li>3. Drain oil and refill to proper level with recommended oil.</li> <li>4. Add oil to proper level, check for leaks.</li> <li>5. Reposition unit on a level surface.</li> </ol>
Moisture in discharge air	Too much moisture in air.	Install inline air filter/dryer, and/or relocate to less humid environment.
Air leaks from pump or fittings	Loose fittings.	Reduce air pressure, then check all fittings with a soap solution for air leaks and tighten as needed. Do not overtighten.
Oil in discharge air or high oil consumption	<ol style="list-style-type: none"> <li>1. Crankcase oil too thin or crankcase overfilled with oil.</li> <li>2. Unit not on level surface.</li> <li>3. Crankcase vent clogged.</li> </ol>	<ol style="list-style-type: none"> <li>1. Drain oil and refill to proper level with recommended oil.</li> <li>2. Reposition unit on a level surface.</li> <li>3. Clean Crankcase vent.</li> </ol>
 <b>Follow all safety precautions whenever diagnosing or servicing the compressor. Disconnect power supply before service.</b>		

**PLEASE READ THE FOLLOWING CAREFULLY**

THE MANUFACTURER AND/OR DISTRIBUTOR HAS PROVIDED THE PARTS LIST AND ASSEMBLY DIAGRAM IN THIS MANUAL AS A REFERENCE TOOL ONLY. NEITHER THE MANUFACTURER OR DISTRIBUTOR MAKES ANY REPRESENTATION OR WARRANTY OF ANY KIND TO THE BUYER THAT HE OR SHE IS QUALIFIED TO MAKE ANY REPAIRS TO THE PRODUCT, OR THAT HE OR SHE IS QUALIFIED TO REPLACE ANY PARTS OF THE PRODUCT. IN FACT, THE MANUFACTURER AND/OR DISTRIBUTOR EXPRESSLY STATES THAT ALL REPAIRS AND PARTS REPLACEMENTS SHOULD BE UNDERTAKEN BY CERTIFIED AND LICENSED TECHNICIANS, AND NOT BY THE BUYER. THE BUYER ASSUMES ALL RISK AND LIABILITY ARISING OUT OF HIS OR HER REPAIRS TO THE ORIGINAL PRODUCT OR REPLACEMENT PARTS THERETO, OR ARISING OUT OF HIS OR HER INSTALLATION OF REPLACEMENT PARTS THERETO.

**Parts List**

Part	Description	Qty
1	Crankcase	1
2	Oil Drain Plug	1
3	Oil Drain Plug Seal	1
4	Oil Sight Glass	1
5	Oil Sight Glass Seal	1
6	Bearing Cover	1
7	Bearing Cover Gasket	1
8	Screw	4
9	Copper Washer	4
10	Oil Fill Plug	1
11	Oil Fill Plug Seal	1
12	Stud Bolt	4
13	1st Stage Cylinder Gasket	1
14	1st Stage Cylinder	1
15	Lock Washer	4
16	Nut	4
17	1st Stage Connecting Rod	1
18	Screw	1
19	Oil Dip Needle	1
20	1st Stage Piston	1
21	1st Stage Piston Pin	1
22	1st Stage Pin Clip	2
23	1st Stage Oil Ring	1
24	1st Stage Compression Ring	2
25	1st Stage Valve Plate Gasket	1
26	1st Stage Inlet Valve Reed	1
27	Reed Locating Pin	2
28	1st Stage Valve Plate	1
29	1st Stage Cylinder Head Gasket	1
30	1st Stage Cylinder Head	1
31	Lock Washer	4
32	Socket Cap Bolt	4
33	Stud Bolt	4
34	2nd Stage Cylinder Gasket	1
35	2nd Stage Cylinder	1
36	Locating Bracket	1
37	Lock Washer	4

Part	Description	Qty
38	Nut	4
39	2nd Stage Connecting Rod	1
40	2nd Stage Piston	1
41	2nd Stage Oil Ring	1
42	2nd Stage Compression Ring	2
43	2nd Stage Piston Pin	1
44	2nd Stage Pin Clip	2
45	2nd Stage Valve Plate Gasket	1
46	2nd Stage Inlet Valve Reed	1
47	Reed Locating Pin	2
48	2nd Stage Valve Plate	1
49	2nd Stage Cylinder Head Gasket	1
50	2nd Stage Cylinder Head	1
51	Lock Washer	4
52	Socket Cap Bolt	4
53	Adapter Fitting	1
54	Air Filter	1
55	Radiator Hose	1
56	Elbow Connector A	1
57	Safety Valve	1
58	Elbow Connector B	1
59	Ball Bearing	1
60	Circle Clip	1
61	Crankshaft	1
62	Ball Bearing	1
63	Bearing Seat Gasket	1
64	Oil Seal	1
65	Bearing Seat	1
66	Breather	1
67	O-Ring	1
68	Copper Washer	6
69	Bolt	6
70	Flywheel	1
71	Woodruff Key	1
72	Washer	1
73	Bolt	1

Record Product's Serial Number Here: \_\_\_\_\_

**Note:** If product has no serial number, record month and year of purchase instead.

**Note:** Some parts are listed and shown for illustration purposes only, and are not available individually as replacement parts.

Visit [harborfreight.com/parts](http://harborfreight.com/parts) for a list of in stock parts. Reference UPC 193175478177.

# Assembly Diagram

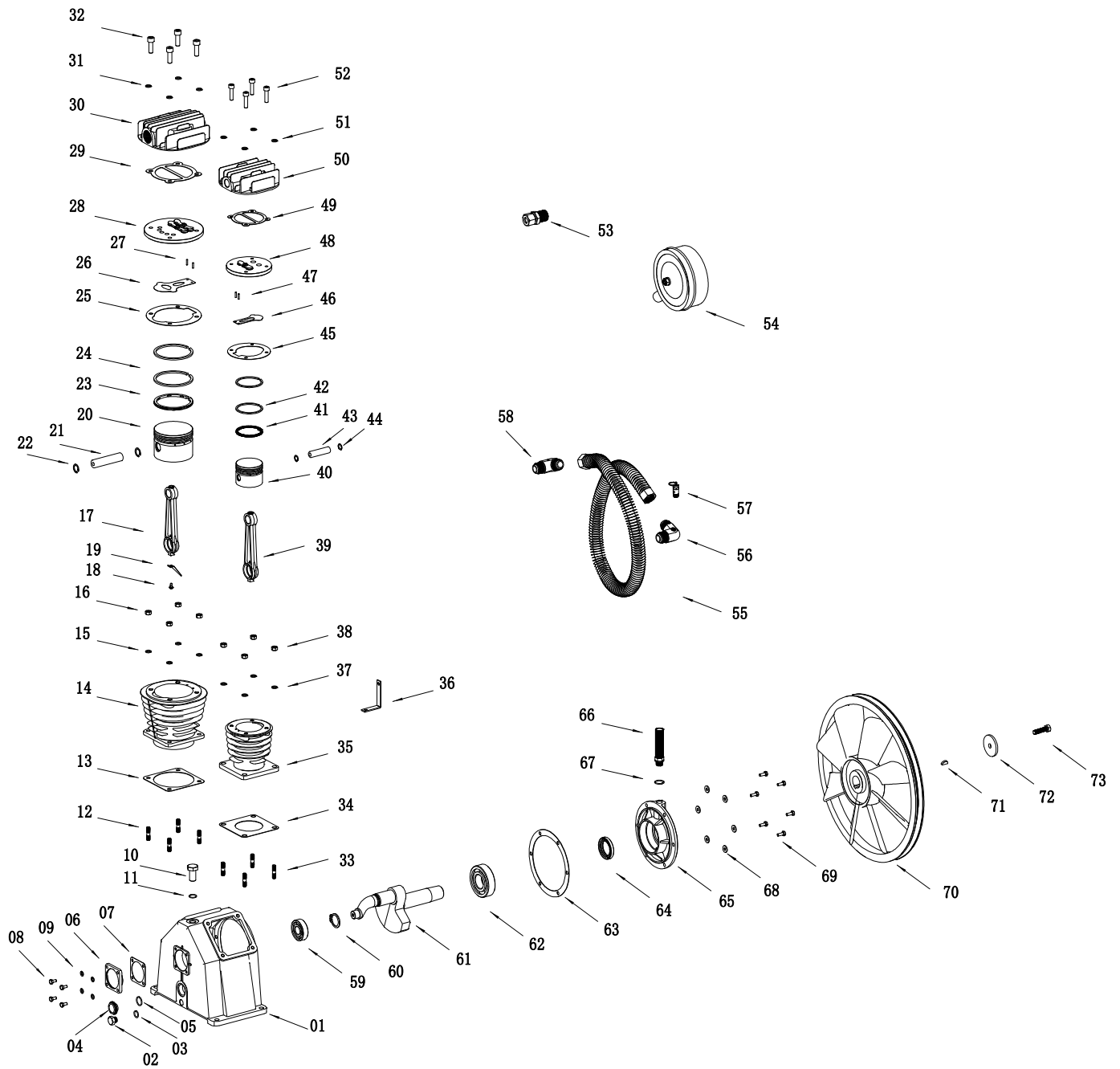

SAFETY

INSTALLATION

MAINTENANCE

PARTS LIST

## Limited 90 Day Warranty

Harbor Freight Tools Co. makes every effort to assure that its products meet high quality and durability standards, and warrants to the original purchaser that this product is free from defects in materials and workmanship for the period of 90 days from the date of purchase. This warranty does not apply to damage due directly or indirectly, to misuse, abuse, negligence or accidents, repairs or alterations outside our facilities, criminal activity, improper installation, normal wear and tear, or to lack of maintenance. We shall in no event be liable for death, injuries to persons or property, or for incidental, contingent, special or consequential damages arising from the use of our product. Some states do not allow the exclusion or limitation of incidental or consequential damages, so the above limitation of exclusion may not apply to you. THIS WARRANTY IS EXPRESSLY IN LIEU OF ALL OTHER WARRANTIES, EXPRESS OR IMPLIED, INCLUDING THE WARRANTIES OF MERCHANTABILITY AND FITNESS.

To take advantage of this warranty, the product or part must be returned to us with transportation charges prepaid. Proof of purchase date and an explanation of the complaint must accompany the merchandise. If our inspection verifies the defect, we will either repair or replace the product at our election or we may elect to refund the purchase price if we cannot readily and quickly provide you with a replacement. We will return repaired products at our expense, but if we determine there is no defect, or that the defect resulted from causes not within the scope of our warranty, then you must bear the cost of returning the product.

This warranty gives you specific legal rights and you may also have other rights which vary from state to state.



26677 Agoura Road • Calabasas, CA 91302 • 1-888-866-5797