

Owner's Manual & Safety Instructions

Save This Manual Keep this manual for the safety warnings and precautions, assembly, operating, inspection, maintenance and cleaning procedures. Write the product's serial number in the back of the manual near the assembly diagram (or month and year of purchase if product has no number). Keep this manual and the receipt in a safe and dry place for future reference.

CENTRALPNEUMATIC®

oilless airbrush compressor



Visit our website at: <http://www.harborfreight.com>
Email our technical support at: tech@harborfreight.com

ITEM 60329

When unpacking, make sure that the product is intact and undamaged. If any parts are missing or broken, please call 1-800-444-3353 as soon as possible.

Copyright© 2013 by Harbor Freight Tools®. All rights reserved.

No portion of this manual or any artwork contained herein may be reproduced in any shape or form without the express written consent of Harbor Freight Tools. Diagrams within this manual may not be drawn proportionally. Due to continuing improvements, actual product may differ slightly from the product described herein. Tools required for assembly and service may not be included.

⚠WARNING

**Read this material before using this product.
Failure to do so can result in serious injury.
SAVE THIS MANUAL.**





Table of Contents

Safety	2	Maintenance	11
Specifications	7	Parts List and Diagram	14
Setup	8	Warranty	16
Operation	10		

SAFETY

CENTRALPNEUMATIC®

WARNING SYMBOLS AND DEFINITIONS

	This is the safety alert symbol. It is used to alert you to potential personal injury hazards. Obey all safety messages that follow this symbol to avoid possible injury or death.
	Indicates a hazardous situation which, if not avoided, will result in death or serious injury.
	Indicates a hazardous situation which, if not avoided, could result in death or serious injury.
	Indicates a hazardous situation which, if not avoided, could result in minor or moderate injury.
	Addresses practices not related to personal injury.

SETUP

OPERATION

IMPORTANT SAFETY INSTRUCTIONS

General Safety Warnings



WARNING Read all safety warnings and instructions.

Failure to follow the warnings and instructions may result in electric shock, fire and/or serious injury.

Save all warnings and instructions for future reference.

The warnings and precautions discussed in this manual cannot cover all possible conditions and situations that may occur. It must be understood by the operator that common sense and caution are factors which cannot be built into this product, but must be supplied by the operator.

MAINTENANCE



Work Area

- a. **Keep the work area clean and well lighted.** Cluttered benches and dark areas increase the risks of electric shock, fire, and injury to persons.
- b. **Do not operate the compressor in explosive atmospheres, such as in the presence of flammable liquids, gases or dust.** Compressor motors produce sparks which may ignite the dust or fumes.
- c. **Keep bystanders, children, and visitors away while operating the tool.** Distractions are able to result in the loss of control of the tool.

Electrical Safety

- a. **Compressor plugs must match the outlet. Never modify the plug in any way. Do not use any adapter plugs with grounded compressors.** Standard plugs and matching outlets will reduce risk of electric shock.
- b. **Do not expose compressor to rain or wet conditions.** Water entering a compressor will increase the risk of electric shock.
- c. **Do not abuse the cord. Never use the cord for unplugging the compressor. Keep cord away from heat, oil, sharp edges or moving parts.** Damaged or entangled cords increase the risk of electric shock.

Personal Safety

- a. **Stay alert. Watch what you are doing and use common sense when operating the tool. Do not use the tool while tired or under the influence of drugs, alcohol, or medication.** A moment of inattention while operating the tool increases the risk of injury to persons.
- b. **Do not overreach. Keep proper footing and balance at all times.** Proper footing and balance enables better control of the tool in unexpected situations.
- c. **Prevent unintentional starting. Ensure the switch is in the off-position before connecting to power source or moving the compressor.**
- d.  **Use safety equipment.** Wear a NIOSH-approved respirator during use.
- e.  **Always wear eye protection.** Wear ANSI-approved safety goggles.

Compressor Use and Care

- a. **Do not use the compressor if the switch does not turn it on and off.** Any compressor that cannot be controlled with the switch is dangerous and must be repaired.
- b. **Disconnect the compressor from the power source before making any adjustments, changing accessories, or storing.** Such preventive safety measures reduce the risk of starting the compressor accidentally.
- c. **Store an idle compressor out of the reach of children and do not allow persons unfamiliar with the compressor or these instructions to operate it.** A compressor is dangerous in the hands of untrained users.
- d. **Maintain the compressor. Keep the compressor clean for better and safer performance. Follow instructions for lubricating. Keep dry, clean and free from oil and grease.** Many accidents are caused by a poorly maintained compressor.

- e. **Check for misalignment or binding of moving parts, breakage of parts and any other condition that may affect the compressor's operation. If damaged, have the compressor repaired before use.** If damaged, have the tool serviced before using. Many accidents are caused by poorly maintained tools. There is a risk of bursting if the tool is damaged.
- f. **Use the compressor in accordance with these instructions, taking into account the working conditions and the work to be performed.** Use of the compressor for operations different from those intended could result in a hazardous situation.

Service

Have your tool serviced by a qualified repair person using only identical replacement parts.
This will ensure that the safety of the tools are maintained.

Specific Safety Instructions



1. Risk of injury - do not direct air stream at people or animals.
2. Risk of bursting - do not adjust regulator higher than marked maximum pressure of attachment.
3. Do not use to supply breathing air.
4. Keep compressor well-ventilated. Do not cover compressor during use.
5. Do not leave compressor unattended for an extended period while plugged in. Unplug compressor after working.
6. Compressor head gets hot during operation. Do not touch it or allow children nearby during or immediately following operation.
7. Do not use the air hose to move the compressor.
8. The use of accessories or attachments not recommended by the manufacturer may result in a risk of injury to persons.
9. All air line components, including hoses, pipe, connectors, filters, etc., must be rated for a minimum working pressure of 150 PSI, or 150% of the maximum system pressure, whichever is greater.
10. Air hose fittings may get hot during use. Allow fittings to cool before disconnecting.
11. Industrial applications must follow OSHA guidelines.
12. This product is not a toy. Keep it out of reach of children.
13. Operate unit on level surface.
14. Maintain labels and nameplates on the tool. These carry important safety information. If unreadable or missing, contact Harbor Freight Tools for a replacement.
15. People with pacemakers should consult their physician(s) before use. Electromagnetic fields in close proximity to heart pacemaker could cause pacemaker interference or pacemaker failure.
16. **WARNING:** The brass components of this product contain lead, a chemical known to the State of California to cause birth defects (or other reproductive harm). (California Health & Safety Code § 25249.5, *et seq.*)
17. **WARNING:** Handling the cord on this product will expose you to lead, a chemical known to the State of California to cause cancer, and birth defects or other reproductive harm. Wash hands after handling. (California Health & Safety Code § 25249.5, *et seq.*)



SAVE THESE INSTRUCTIONS.

Symbol Definitions

Symbol	Property or Statement
PSI	Pounds per square inch of pressure
CFM	Cubic Feet per Minute flow
SCFM	Cubic Feet per Minute flow at standard conditions
NPT	National pipe thread, tapered

Symbol	Property or Statement
NPS	National pipe thread, straight
	WARNING marking concerning Risk of Eye Injury. Wear ANSI-approved eye protection.
	WARNING marking concerning Risk of Respiratory Injury. Wear NIOSH-approved respirator.
	WARNING marking concerning Risk of Explosion.

SAFETY

SETUP

OPERATION

MAINTENANCE

! WARNING



TO PREVENT ELECTRIC SHOCK AND DEATH FROM INCORRECT GROUNDING WIRE CONNECTION:

Check with a qualified electrician if you are in doubt as to whether the outlet is properly grounded. Do not modify the power cord plug provided with the compressor. Never remove the grounding prong from the plug. Do not use the compressor if the power cord or plug is damaged. If damaged, have it repaired by a service facility before use. If the plug will not fit the outlet, have a proper outlet installed by a qualified electrician.

Grounded Compressors: Compressors with Three Prong Plugs

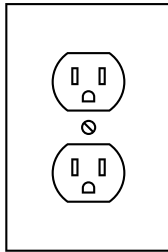
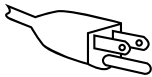

3-Prong Plug and Outlet

1. Tools marked with "Grounding Required" have a three wire cord and three prong grounding plug. The plug must be connected to a properly grounded outlet. If the tool should electrically malfunction or break down, grounding provides a low resistance path to carry electricity away from the user, reducing the risk of electric shock. (See 3-Prong Plug and Outlet.)

2. The grounding prong in the plug is connected through the green wire inside the cord to the grounding system in the tool. The green wire in the cord must be the only wire connected to the tool's grounding system and must never be attached to an electrically "live" terminal. (See 3-Prong Plug and Outlet.)
3. The tool must be plugged into an appropriate outlet, properly installed and grounded in accordance with all codes and ordinances. The plug and outlet should look like those in the preceding illustration. (See 3-Prong Plug and Outlet.)

Extension Cords

1. **Grounded** tools require a three wire extension cord.
2. As the distance from the supply outlet increases, you must use a heavier gauge extension cord. Using extension cords with inadequately sized wire causes a serious drop in voltage, resulting in loss of power and possible tool damage. (See Table A.)
3. The smaller the gauge number of the wire, the greater the capacity of the cord. For example, a 14 gauge cord can carry a higher current than a 16 gauge cord. (See Table A.)
4. When using more than one extension cord to make up the total length, make sure each cord contains at least the minimum wire size required. (See Table A.)
5. If you are using one extension cord for more than one tool, add the nameplate amperes and use the sum to determine the required minimum cord size. (See Table A.)
6. If you are using an extension cord outdoors, make sure it is marked with the suffix "W-A" ("W" in Canada) to indicate it is acceptable for outdoor use.

7. Make sure the extension cord is properly wired and in good electrical condition. Always replace a damaged extension cord or have it repaired by a qualified electrician before using it.
8. Protect the extension cords from sharp objects, excessive heat, and damp or wet areas.

TABLE A: RECOMMENDED MINIMUM WIRE GAUGE FOR EXTENSION CORDS* (120/240 VOLT)					
NAMEPLATE AMPERES (at full load)	EXTENSION CORD LENGTH				
	25'	50'	75'	100'	150'
0 – 2.0	18	18	18	18	16
2.1 – 3.4	18	18	18	16	14
3.5 – 5.0	18	18	16	14	12
5.1 – 7.0	18	16	14	12	12
7.1 – 12.0	18	14	12	10	-
12.1 – 16.0	14	12	10	-	-
16.1 – 20.0	12	10	-	-	-

*** Based on limiting the line voltage drop to five volts at 150% of the rated amperes.**

Specifications

Electrical Rating	120V~ / 2A
Motor Speed	1,750 RPM
Power Cord	6'
Maximum Air Pressure	58 PSI
Air Outlet	1/8" - 27 NPS
Air Output	0.5 CFM @ 20 PSI

Setup: Before Use



Read the **ENTIRE IMPORTANT SAFETY INFORMATION** section at the beginning of this manual including all text under subheadings therein before set up or use of this product.

Note: For additional information regarding the parts listed in the following pages, refer to the Assembly Diagram near the end of this manual.

Functions

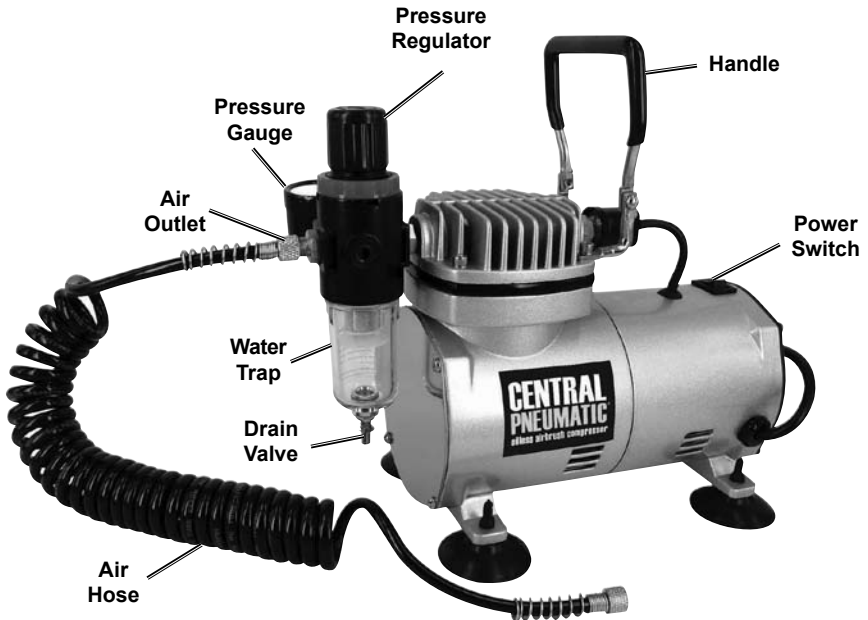

Figure A

Compressor Setup

⚠️ WARNING

TO PREVENT SERIOUS INJURY FROM ACCIDENTAL OPERATION:

Turn the Power Switch “OFF” and unplug the Compressor from its electrical outlet before assembling or making any adjustments to the Compressor.

1. Designate an area that is clean and well-lit. The work area must not allow access by children or pets to prevent distraction and injury.
2. Before operating, make sure Compressor is set up in a well-ventilated area, on a flat, level, solid surface well away from any flammable objects, such as drapes.
3. Keep at least 12" of space around Compressor to allow for air circulation.
4. Route Power Cord from Compressor to grounded wall outlet, along a safe path, without creating a tripping hazard or exposing the Power Cord to possible damage.
5. Insert Power Cord into grounded outlet.
6. Connect one end of Air Hose to Air Outlet of Compressor.
7. Connect other end of Air Hose to Air Inlet of Airbrush (not included).
8. Turn on Power Switch and inspect air connections for leaks.
9. Turn off and unplug Compressor, then repair any leaks found.

Operating Instructions



Read the **ENTIRE IMPORTANT SAFETY INFORMATION** section at the beginning of this manual including all text under subheadings therein before set up or use of this product.

⚠️ WARNING

TO PREVENT SERIOUS INJURY:

Do not adjust or tamper with any control or component in a way not specifically explained within this manual. Improper adjustment can result in tool failure or other serious hazards.

General Operation

Note: This Compressor will automatically shut off on overload or under excessive heat.

Should this occur, turn Power Switch off. Wait until the Compressor cools. Then, turn Power Switch on to resume work.

1. Insert Power Cord plug into grounded outlet.
2. Connect one end of Air Hose to Air Outlet of Compressor.
3. Connect an Airbrush (not included) to the other end of Air Hose.

Note: Use this Compressor only with Airbrushes; do not use this Compressor with any other type of painting equipment.

4. Turn the Power Switch on.
5. Adjust air pressure by lifting the Pressure Regulator, turning it until proper pressure is attained, then pressing it back down.
6. When finished using the Compressor, turn its Power Switch off. Release any remaining air, then disconnect the Airbrush.
7. Perform maintenance on the Compressor according to the instructions on the following pages.
8. Perform maintenance on the Airbrush according to Airbrush manufacturer's instructions.

Maintenance Instructions



Procedures not specifically explained in this manual must be performed only by a qualified technician.

⚠️WARNING

TO PREVENT SERIOUS INJURY FROM COMPRESSOR FAILURE:
Do not use damaged equipment. If abnormal noise, vibration, or leaking air occurs, have the problem corrected before further use.

TO PREVENT SERIOUS INJURY FROM ACCIDENTAL OPERATION:
Turn the Power Switch “OFF” and unplug the Compressor from its electrical outlet before performing any inspection, maintenance, or cleaning procedures.

Inspection and Maintenance

Note: These procedures are in addition to the regular checks and maintenance explained as part of the regular operation of the Compressor and air-operated tool.

1. **BEFORE EACH USE**, inspect the general condition of the Compressor. Check for:
 - loose screws,
 - misalignment or binding of moving parts,
 - damaged air supply hose,
 - cracked or broken parts, and
 - any other condition that may affect its safe operation.
2. **AFTER EACH USE:**
 - a. Drain Water Trap:
 - With Compressor running, drain moisture by depressing Drain Valve at bottom of Water Trap. Moisture will be forced out.
 - Turn off and disconnect Compressor from its power source.
 - b. Wipe Compressor with clean cloth.
3. **EVERY THREE MONTHS:**
 - Clean the Water Trap filter by blowing with compressed air.
4. **⚠️WARNING! If the supply cord of this Compressor is damaged, it must be replaced only by a qualified service technician.**

Storage

Store Compressor in a dry, secure area out of reach of children.

Troubleshooting

SAFETY

SETUP

OPERATION

MAINTENANCE

Problem	Possible Causes	Likely Solutions
The motor does not work.	<ol style="list-style-type: none"> 1. No electrical power. 2. Damaged power cord. 3. Electrical wiring within the unit is defective. 4. Power switch is defective. 	<ol style="list-style-type: none"> 1. Plug power cord into a working, 120V~, grounded, electrical outlet. 2. Have a qualified service technician replace power cord. 3. Have a qualified service technician replace electrical wiring. 4. Have a qualified service technician replace power switch.
The motor runs, but it makes irregular noises or a knocking noise.	<ol style="list-style-type: none"> 1. Bearing is loose or damaged. 2. Screws in the connection rod are loose. 	<ol style="list-style-type: none"> 1. Have a qualified service technician replace bearing. 2. Tighten screws, or replace them if necessary.
Not enough pressure when painting or spraying.	<ol style="list-style-type: none"> 1. Loose air connection(s). 2. Air hose is damaged. 3. Screws on cylinder cover are loose. 	<ol style="list-style-type: none"> 1. Check all air connections, and tighten them if necessary. 2. Replace air hose. 3. Tighten screws.
Motor runs properly, but no air pressure or lack of air delivery.	<ol style="list-style-type: none"> 1. Valve plate is loose or out of place. 2. Retainer ring is damaged after excessive use at high pressure. 	<ol style="list-style-type: none"> 1. Open the front cover and make sure the valve plate is in the proper position. Tighten screws if necessary. 2. Have a qualified service technician replace the retainer ring.
<div style="display: flex; align-items: center;">  <p>Follow all safety precautions whenever diagnosing or servicing the Compressor. Disconnect power supply before service.</p> </div>		

PLEASE READ THE FOLLOWING CAREFULLY

THE MANUFACTURER AND/OR DISTRIBUTOR HAS PROVIDED THE PARTS LIST AND ASSEMBLY DIAGRAM IN THIS MANUAL AS A REFERENCE TOOL ONLY. NEITHER THE MANUFACTURER OR DISTRIBUTOR MAKES ANY REPRESENTATION OR WARRANTY OF ANY KIND TO THE BUYER THAT HE OR SHE IS QUALIFIED TO MAKE ANY REPAIRS TO THE PRODUCT, OR THAT HE OR SHE IS QUALIFIED TO REPLACE ANY PARTS OF THE PRODUCT. IN FACT, THE MANUFACTURER AND/OR DISTRIBUTOR EXPRESSLY STATES THAT ALL REPAIRS AND PARTS REPLACEMENTS SHOULD BE UNDERTAKEN BY CERTIFIED AND LICENSED TECHNICIANS, AND NOT BY THE BUYER. THE BUYER ASSUMES ALL RISK AND LIABILITY ARISING OUT OF HIS OR HER REPAIRS TO THE ORIGINAL PRODUCT OR REPLACEMENT PARTS THERETO, OR ARISING OUT OF HIS OR HER INSTALLATION OF REPLACEMENT PARTS THERETO.

Record Product's Serial Number Here: _____

Note: If product has no serial number, record month and year of purchase instead.

Note: Some parts are listed and shown for illustration purposes only, and are not available individually as replacement parts.

Parts List and Diagram

Parts List

Part	Description	Qty
1	Screw	4
2	Washer	8
3	Handle	1
4	Cylinder Head	1
5	O-Ring	1
6	Pressure Switch	1
7	Check Valve	1
8	Cylinder Block	1
9	O-Ring	1
10	Cylinder	1
11	Screw	1
12	Valve Plate	1
13	Screw	1
14	Piston Plate	1
15	Piston Ring	1
16	Piston Rod	1
17	Bearing	1
18	Crankshaft	1
19	Front Body	1
20	Paper Pad	1

Part	Description	Qty
21	Front Cover	1
22	Bearing	2
23	Stator	1
24	Rotor	1
25	Rear Body	1
26	Power Switch	1
27	Condenser	1
28	Screw	4
29	Rear Cover	1
30	Screw	8
31	Power Cord	1
32	Line Button	1
33	Nipple	2
34	Water Trap/Pressure Regulator	1
35	Pressure Gauge	1
36	Foot	4
37	Pressing Wire Hat	1
38	Snap Ring	1
39	Grommet	1
40	Air Hose (not shown)	1

SAFETY

SETUP

OPERATION

MAINTENANCE

Assembly Diagram

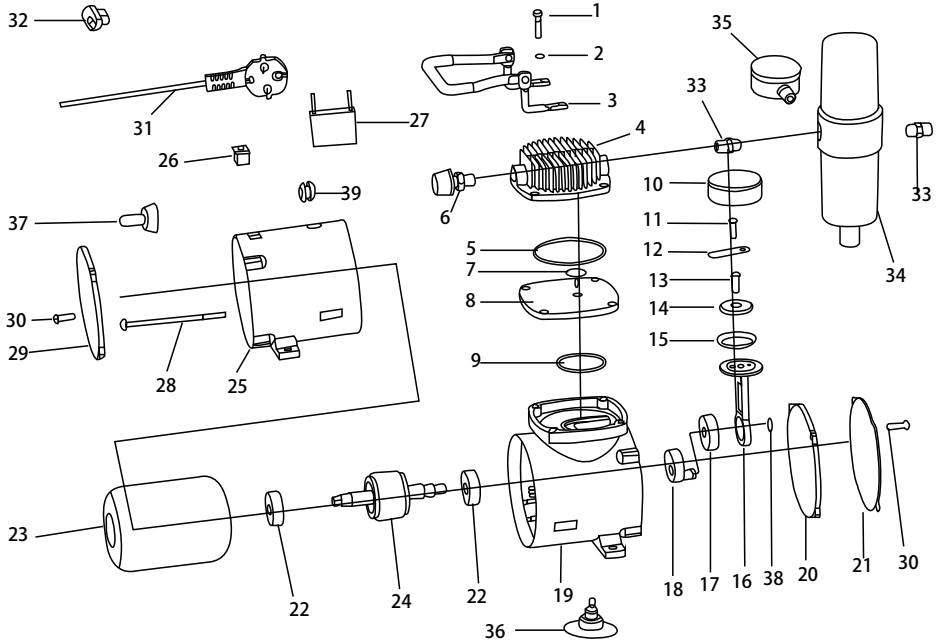

SAFETY

SETUP

OPERATION

MAINTENANCE

Limited 90 Day Warranty

Harbor Freight Tools Co. makes every effort to assure that its products meet high quality and durability standards, and warrants to the original purchaser that this product is free from defects in materials and workmanship for the period of 90 days from the date of purchase. This warranty does not apply to damage due directly or indirectly, to misuse, abuse, negligence or accidents, repairs or alterations outside our facilities, criminal activity, improper installation, normal wear and tear, or to lack of maintenance. We shall in no event be liable for death, injuries to persons or property, or for incidental, contingent, special or consequential damages arising from the use of our product. Some states do not allow the exclusion or limitation of incidental or consequential damages, so the above limitation of exclusion may not apply to you. THIS WARRANTY IS EXPRESSLY IN LIEU OF ALL OTHER WARRANTIES, EXPRESS OR IMPLIED, INCLUDING THE WARRANTIES OF MERCHANTABILITY AND FITNESS.

To take advantage of this warranty, the product or part must be returned to us with transportation charges prepaid. Proof of purchase date and an explanation of the complaint must accompany the merchandise. If our inspection verifies the defect, we will either repair or replace the product at our election or we may elect to refund the purchase price if we cannot readily and quickly provide you with a replacement. We will return repaired products at our expense, but if we determine there is no defect, or that the defect resulted from causes not within the scope of our warranty, then you must bear the cost of returning the product.

This warranty gives you specific legal rights and you may also have other rights which vary from state to state.

CENTRALPNEUMATIC®