

Owner's Manual & Safety Instructions

Save This Manual Keep this manual for the safety warnings and precautions, assembly, operating, inspection, maintenance and cleaning procedures. Write the product's serial number in the back of the manual near the assembly diagram (or month and year of purchase if product has no number). Keep this manual and the receipt in a safe and dry place for future reference.

REV 15c



ITEM 60446

Electric Paint Spray Gun



NOTICE

CLEAN IMMEDIATELY

Clean the Spray Gun IMMEDIATELY after EVERY use, in between coats, and when it will be idle for more than 5 minutes.

Delayed or inadequate cleaning will permanently clog the Spray Gun.

Visit our website at: <http://www.harborfreight.com>
Email our technical support at: productsupport@harborfreight.com

When unpacking, make sure that the product is intact and undamaged. If any parts are missing or broken, please call 1-888-866-5797 as soon as possible.

Copyright © 2014 by Harbor Freight Tools®. All rights reserved.

No portion of this manual or any artwork contained herein may be reproduced in any shape or form without the express written consent of Harbor Freight Tools. Diagrams within this manual may not be drawn proportionally. Due to continuing improvements, actual product may differ slightly from the product described herein. Tools required for assembly and service may not be included.

⚠ WARNING

Read this material before using this product.
Failure to do so can result in serious injury.
SAVE THIS MANUAL.

NOTICE

Clean the Spray Gun IMMEDIATELY after EVERY use.
Delayed or inadequate cleaning will permanently clog the Spray Gun.
Latex paint hardens quickly and permanently inside Spray Gun.

Table of Contents

Safety	2	Maintenance	14
Specifications	7	Parts List and Diagram	19
Cleaning	8	Warranty	20



WARNING SYMBOLS AND DEFINITIONS

	This is the safety alert symbol. It is used to alert you to potential personal injury hazards. Obey all safety messages that follow this symbol to avoid possible injury or death.
	Indicates a hazardous situation which, if not avoided, will result in death or serious injury.
	Indicates a hazardous situation which, if not avoided, could result in death or serious injury.
	Indicates a hazardous situation which, if not avoided, could result in minor or moderate injury.
	Addresses practices not related to personal injury.

IMPORTANT SAFETY INSTRUCTIONS

INSTRUCTIONS PERTAINING TO A RISK OF FIRE, ELECTRIC SHOCK, OR INJURY TO PERSONS

The warnings and precautions discussed in this manual cannot cover all possible conditions and situations that may occur. It must be understood by the operator that common sense and caution are factors which cannot be built into this product, but must be supplied by the operator.

WARNING – When using tools, basic precautions should always be followed, including the following:

NOTICE

Clean the Spray Gun IMMEDIATELY after EVERY use.
Delayed or inadequate cleaning will permanently clog the Spray Gun.
Latex paint hardens quickly and permanently inside Spray Gun.



Work Area

- 1. Keep the work area clean and well lighted.**
Cluttered benches and dark areas increase the risks of electric shock, fire, and injury to persons.
- 2. Do not operate power tools in explosive atmospheres, such as in the presence of flammable liquids, gases or dust.**
Power tools create sparks which may ignite the dust or fumes.
- 3. Keep bystanders, children, and visitors away while operating the tool.**
Distractions are able to result in the loss of control of the tool.

Electrical safety

- 1. Power tool plugs must match the outlet. Never modify the plug in any way. Do not use any adapter plugs with grounded power tools.**
Unmodified plugs and matching outlets will reduce risk of electric shock.
- 2. Avoid body contact with grounded surfaces such as pipes, radiators, ranges and refrigerators.** *There is an increased risk of electric shock if your body is grounded.*
- 3. Do not expose power tools to rain or wet conditions.** *Water entering a power tool will increase the risk of electric shock.*
- 4. Do not abuse the cord. Never use the cord for carrying, pulling or unplugging the power tool. Keep cord away from heat, oil, sharp edges or moving parts.**
Damaged or entangled cords increase the risk of electric shock.
- 5. When operating a power tool outdoors, use an extension cord suitable for outdoor use.**
Use of a cord suitable for outdoor use reduces the risk of electric shock.
- 6. If operating a power tool in a damp location is unavoidable, use a Ground Fault Circuit Interrupter (GFCI) protected supply.** *Use of a GFCI reduces the risk of electric shock.*

Personal Safety

- 1. Stay alert. Watch what you are doing and use common sense when operating the tool. Do not use the tool while tired or under the influence of drugs, alcohol, or medication.**
A moment of inattention while operating the tool increases the risk of injury to persons.
- 2. Dress properly. Do not wear loose clothing or jewelry. Contain long hair. Keep hair, clothing, and gloves away from moving parts.**
Loose clothes, jewelry, or long hair increases the risk of injury to persons as a result of being caught in moving parts.
- 3. Do not overreach. Keep proper footing and balance at all times.**
Proper footing and balance enables better control of the tool in unexpected situations.
-  **4. Use safety equipment.**
Wear heavy-duty work gloves and a NIOSH-approved respirator during use. Non-skid safety shoes and a hard hat must be used for the applicable conditions.
-  **5. Always wear eye protection.**
Wear ANSI-approved safety goggles.

NOTICE

Clean the Spray Gun **IMMEDIATELY** after **EVERY** use.
Delayed or inadequate cleaning will permanently clog the Spray Gun.
Latex paint hardens quickly and permanently inside Spray Gun.

Tool Use and Care

1. **Do not force the tool.** Use the correct tool for the application. The correct tool will do the job better and safer at the rate for which the tool is designed.
2. **Unplug the tool before making any adjustments, changing accessories, or storing the tool.** Such preventive safety measures reduce the risk of starting the tool unintentionally. Unplug the tool, safely discharge any residual pressure, and release the trigger before leaving the work area.
3. **Store the tool when it is idle out of reach of children and other untrained persons.** A tool is dangerous in the hands of untrained users.
4. **Check for misalignment or binding of moving parts, breakage of parts, and any other condition that affects the tool's operation.** If damaged, have the tool serviced before using. Many accidents are caused by poorly maintained tools.
5. **Use only accessories that are identified by the manufacturer for the specific tool model.** Use of an accessory not intended for use with the specific tool model, increases the risk of injury to persons.

Service

Have your power tool serviced by a qualified repair person using only identical replacement parts. *This will ensure that the safety of the power tool is maintained.*

Specific Safety Instructions

1. **To reduce the risk of electric shock, do not expose to rain. Store indoors.**
2. **Risk of Explosion – Do not spray flammable liquids.**
3. Do not direct spray at people or animals.
4. Read all of the information concerning coating products and cleaning solvents. **Do not use chlorinated solvents (e.g. 1-1-1 trichloroethylene and dichloromethane, also known as methylene chloride) to clean spray guns. Many spray guns contain aluminum, which reacts strongly to chlorinated solvents.** Contact the solvent or coating manufacturer as needed regarding potential chemical reactions.
5. Industrial applications must follow OSHA requirements.
6. Risk of injection - Do not point spray gun at any person or any part of the body. In case of skin injection, seek medical attention immediately.
7. Spraying hazardous materials may result in serious injury or death. Do not spray pesticide, acid, corrosive material, fertilizer, or toxic chemicals.
8. Paints and solvents may be harmful or fatal if swallowed or inhaled. Avoid prolonged skin contact with solvents or paints as they will irritate skin. After any contact, immediately wash off exposed area with hot, soapy water.
9. Attach all accessories properly to the tool before plugging in the tool. A loose accessory may detach or break during operation.

NOTICE

Clean the Spray Gun IMMEDIATELY after EVERY use.
Delayed or inadequate cleaning will permanently clog the Spray Gun.
Latex paint hardens quickly and permanently inside Spray Gun.

10. Maintain labels and nameplates on the tool. These carry important safety information. If unreadable or missing, contact Harbor Freight Tools for a replacement.
11. Avoid unintentional starting. Prepare to begin work before turning on the tool.
12. Do not leave the tool unattended when it is plugged into an electrical outlet. Turn off the tool, and unplug it from its electrical outlet before leaving.
13. This product is not a toy. Keep it out of reach of children.
14. People with pacemakers should consult their physician(s) before use. Electromagnetic fields in close proximity to heart pacemaker could cause pacemaker interference or pacemaker failure. In addition, people with pacemakers should:
 - Avoid operating alone.
 - Do not use with power switch locked on.
 - Properly maintain and inspect to avoid electrical shock.
 - Properly ground power cord. Ground Fault Circuit Interrupter (GFCI) should also be implemented – it prevents sustained electrical shock.
15. WARNING: The cord of this product contains lead and/or di (2-ethylhexyl) phthalate (DEHP), chemicals known to the State of California to cause cancer, and birth defects or other reproductive harm. Wash hands after handling. (California Health & Safety Code § 25249.5, *et seq.*)
16. WARNING: Some dust created by power sanding, sawing, grinding, drilling, and other construction activities, contains chemicals known to the State of California to cause cancer and birth defects or other reproductive harm. Some examples of these chemicals are:
 - Lead from lead-based paints
 - Crystalline silica from bricks and cement or other masonry products
 - Arsenic and chromium from chemically treated lumberYour risk from these exposures varies, depending on how often you do this type of work. To reduce your exposure to these chemicals: work in a well ventilated area, and work with approved safety equipment, such as those dust masks that are specially designed to filter out microscopic particles. (California Health & Safety Code § 25249.5, *et seq.*)
17. The warnings, precautions, and instructions discussed in this instruction manual cannot cover all possible conditions and situations that may occur. It must be understood by the operator that common sense and caution are factors which cannot be built into this product, but must be supplied by the operator.



SAVE THESE INSTRUCTIONS.

SAFETY

OPERATION

CLEANING

MAINTENANCE

NOTICE

Clean the Spray Gun IMMEDIATELY after EVERY use.
Delayed or inadequate cleaning will permanently clog the Spray Gun.
Latex paint hardens quickly and permanently inside Spray Gun.

Grounding

⚠ WARNING



TO PREVENT ELECTRIC SHOCK AND DEATH FROM INCORRECT GROUNDING WIRE CONNECTION:

Check with a qualified electrician if you are in doubt as to whether the outlet is properly grounded. Do not modify the power cord plug provided with the tool.

Never remove the grounding prong from the plug. Do not use the tool if the power cord or plug is damaged. If damaged, have it repaired by a service facility before use. If the plug will not fit the outlet, have a proper outlet installed by a qualified electrician.

Double Insulated Tools: Tools with Two Prong Plugs

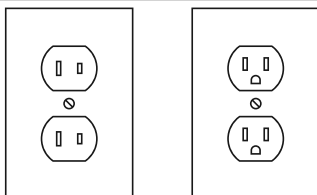

Figure A: Outlets for 2-Prong Plug

1. Tools marked "Double Insulated" do not require grounding. They have a special double insulation system which satisfies OSHA requirements and complies with the applicable standards of Underwriters Laboratories, Inc., the Canadian Standard Association, and the National Electrical Code.
2. Double insulated tools may be used in either of the 120 volt outlets shown in the preceding illustration. (See Figure A.)
3. This appliance has a polarized plug (one blade is wider than the other). This plug will fit in a polarized outlet only one way. If the plug does not fit fully in the outlet, reverse the plug. If it still does not fit, contact a qualified electrician to install the proper outlet. Do not change the plug in any way.

Extension Cords

1. **Grounded** tools require a three wire extension cord. **Double Insulated** tools can use either a two or three wire extension cord.
2. As the distance from the supply outlet increases, you must use a heavier gauge extension cord. Using extension cords with inadequately sized wire causes a serious drop in voltage, resulting in loss of power and possible tool damage. (See Table A.)
3. The smaller the gauge number of the wire, the greater the capacity of the cord. For example, a 14 gauge cord can carry a higher current than a 16 gauge cord. (See Table A.)
4. When using more than one extension cord to make up the total length, make sure each cord contains at least the minimum wire size required. (See Table A.)
5. If you are using one extension cord for more than one tool, add the nameplate amperes and use the sum to determine the required minimum cord size. (See Table A.)

NOTICE

Clean the Spray Gun **IMMEDIATELY** after **EVERY** use.
Delayed or inadequate cleaning will permanently clog the Spray Gun.
Latex paint hardens quickly and permanently inside Spray Gun.

6. If you are using an extension cord outdoors, make sure it is marked with the suffix "W-A" ("W" in Canada) to indicate it is acceptable for outdoor use.
7. Make sure the extension cord is properly wired and in good electrical condition. Always replace a damaged extension cord or have it repaired by a qualified electrician before using it.
8. Protect the extension cords from sharp objects, excessive heat, and damp or wet areas.

Symbology







	Double Insulated
VAC	Volts Alternating Current
A	Amperes
	WARNING marking concerning Risk of Eye Injury. Wear ANSI-approved eye protection.
	WARNING marking concerning Risk of Respiratory Injury. Wear NIOSH-approved respirator.
	WARNING marking concerning Risk of Explosion.
	WARNING marking concerning Risk of Fire. Do not use solvents improperly.
	WARNING marking concerning Risk of Electric Shock. Properly connect power cord to appropriate outlet.

Table A: Recommended Minimum Wire Gauge for Extension Cords* (120/240 Volt)

NAMEPLATE AMPERES (at full load)	EXTENSION CORD LENGTH				
	25'	50'	75'	100'	150'
0 – 2.0	18	18	18	18	16
2.1 – 3.4	18	18	18	16	14
3.5 – 5.0	18	18	16	14	12
5.1 – 7.0	18	16	14	12	12
7.1 – 12.0	18	14	12	10	-
12.1 – 16.0	14	12	10	-	-
16.1 – 20.0	12	10	-	-	-

* Based on limiting the line voltage drop to five volts at 150% of the rated amperes.

Specifications

Electrical Rating	120VAC, 60Hz, 1.2A
Container Capacity	24 fl. oz.
Flow Rate	5 GPH

Accessories	Viscosity Cup with hanger/ Four Nozzles including: 2 - .032" (0.8mm), 1 - .021" (0.5mm), 1 - Extension .021" (0.5mm)
-------------	--

HOUSEHOLD USE ONLY.



Intertek
4005149

NOTICE

Clean the Spray Gun IMMEDIATELY after EVERY use.
Delayed or inadequate cleaning will permanently clog the Spray Gun.
Latex paint hardens quickly and permanently inside Spray Gun.

SAFETY

Components

OPERATION

CLEANING

MAINTENANCE



Figure B

NOTICE

Clean the Spray Gun IMMEDIATELY after EVERY use.
Delayed or inadequate cleaning will permanently clog the Spray Gun.
Latex paint hardens quickly and permanently inside Spray Gun.

Operation



Read the **ENTIRE IMPORTANT SAFETY INFORMATION** section at the beginning of this manual including all text under subheadings therein before set up or use of this product.

! WARNING

TO PREVENT SERIOUS INJURY:

Inspect tool before use, looking for damaged, loose, and missing parts.
If any problems are found, do not use tool until repaired.

Note: For additional information regarding the parts listed in the following pages, refer to the Assembly Diagram near the end of this manual.

Workpiece and Work Area Set Up

1. Designate a work area that is clean and well lit. The work area must not allow access by children or pets to prevent distraction and injury.
2. Before spraying, mask nearby objects not being sprayed and lay cloths (not included) on the floors.



NOTICE

Clean the Spray Gun IMMEDIATELY after EVERY use.
Delayed or inadequate cleaning will permanently clog the Spray Gun.
Latex paint hardens quickly and permanently inside Spray Gun.

Before First Use

NOTICE: Before first use, clean the Spray Gun thoroughly.

If not removed, the material used for testing and corrosion prevention will contaminate material.

Note: Do not immerse Spray Gun Body in liquid.

1. Unplug the Spray Gun from its electrical outlet.
2. Remove the Container.
3. Fill the Container with warm soapy water, then replace the Container.
4. Attach a Nozzle.
5. Plug the Spray Gun into an electrical outlet.
6. Depress the Trigger to spray the warm soapy water through the Spray Gun and into a bucket, while shaking the Spray Gun.
7. Fill the Container with plain warm water.
8. Depress the Trigger to spray the plain warm water through the Spray Gun and into a bucket, while shaking the Spray Gun.

9. Unplug the Spray Gun from its electrical outlet.
10. Remove the Container and Suction Tube, then thoroughly dry all parts.
11. Apply a few drops of spray gun lubricant as indicated in **Figure C**.

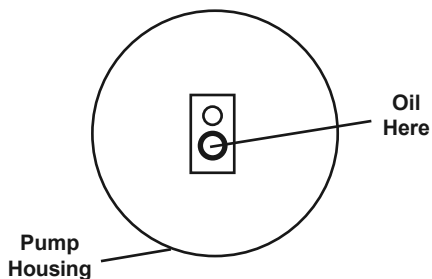

Figure C

12. Reassemble the Spray Gun.

NOTICE

Clean the Spray Gun IMMEDIATELY after EVERY use.
Delayed or inadequate cleaning will permanently clog the Spray Gun.
Latex paint hardens quickly and permanently inside Spray Gun.

Spray Gun Setup and Adjustment

Material Preparation and Filling

Note: This Spray Gun can be used for spraying oil-based or water based materials, including latex.

IMPORTANT! BEFORE THINNING, CHECK THE VISCOSITY OF THE MATERIAL.

1. Fully submerge the included Viscosity Cup into the material.
2. Lift the Cup out of the material and time how many seconds it takes for it to completely run out of the cup.

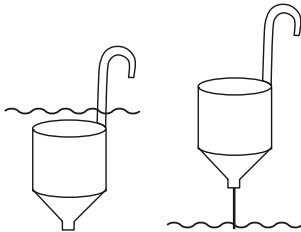

Figure D

3. Refer to **Viscosity Chart** for recommended times for different materials.

Material	Time in seconds
Water-Based Paint Varnish	20 - 25
Oil-Based Paint Enamel Paint	18 - 22
Primer	24 - 28
Wood Sealer	28 - 35
Wood Stain	No thinning Required

Figure E: Viscosity Chart

Note: Proper material mixture is essential. Follow the manufacturer's directions for thinning instructions.

Most materials will spray easily if they are thinned properly.

4. If necessary, thin the material according to manufacturer's directions and mix thoroughly.
5. Check viscosity. Thin and check until proper viscosity is achieved.
6. Carefully strain the material through a paint strainer or a piece of cheesecloth.
7. Fill the Container 3/4 full, then replace it on the Pump Housing.
8. Attach the appropriate Nozzle for the application. Tighten firmly.
9. Plug the Spray Gun into an electrical outlet.

Note: For painting ceilings, attach the Extension Nozzle first.

Fluid Adjustment

1. Test the consistency by spraying on a piece of scrap material.
2. Adjust the Regulator until proper material flow is achieved.

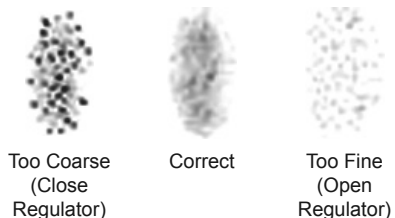

Figure F: Fluid Adjustment

NOTICE

Clean the Spray Gun IMMEDIATELY after EVERY use.
Delayed or inadequate cleaning will permanently clog the Spray Gun.
Latex paint hardens quickly and permanently inside Spray Gun.

Spraying Technique

When first filled, the gun may take up to 30 seconds after the trigger is held to prime and start spraying.

IMPORTANT: Proper spraying technique is ESSENTIAL to achieve good results.

1. First, prepare the Spray Gun according to the instructions on **page 9**.
2. **Keep the Spray Gun upright and at a right angle to the work piece**

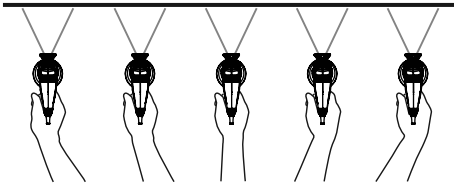

Correct Gun Angle

Move your arm, not just your wrist.

Point gun directly towards the surface and maintain an even, steady distance and speed.

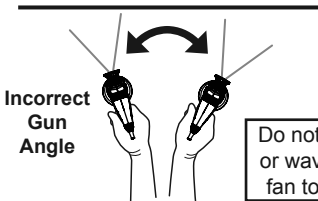

Incorrect Gun Angle

Do not pivot your wrist or wave the gun like a fan towards the wall.

Figure H: Spray Gun Angle - top view

3. Using two hands, one to steady the Container and the other to operate the Spray Gun, aim Nozzle at the work piece.

CAUTION: DO NOT STOP WHEN SPRAYING. Spraying materials will start to set and dry as soon as they come in contact with the air. They will cause a permanent clog if not cleared immediately. If discontinuing spraying, clean the Spray Gun according to **After Every Use on page 14**.

4. Pull Trigger slowly and move Spray Gun in parallel strokes to the work piece. Keep the distance from the work piece at about 10" to 12", depending on the flow adjustment and the paint.
5. To avoid paint build up, start moving the Spray Gun **before** squeezing the Trigger. When finished with the stroke, release the Trigger **while still moving** the Spray Gun. Doing this will produce a smoother finish. Do not stop moving the Spray Gun while spraying. If the Spray Gun stops even briefly while spraying the paint will build up and run down the work piece.

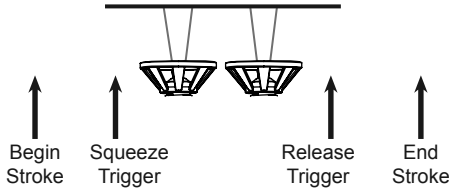

Figure I: Paint Stroke Triggering - top view

Note: The stroke speed, the Regulator adjustment, and the distance from the work piece, will determine how much paint is being applied. Apply two thin coats rather than one thick coat.

6. **KEEP CONTAINER FILLED.** Do not allow material to drain out completely to prevent pump cavitation.
7. To prevent accidents, release trigger, unplug the tool, safely discharge any residual pressure, and again release trigger after use.
8. **Clean Spray Gun thoroughly immediately after EVERY use, according to After Every Use on page 14.**

NOTICE

Clean the Spray Gun IMMEDIATELY after EVERY use.
Delayed or inadequate cleaning will permanently clog the Spray Gun.
Latex paint hardens quickly and permanently inside Spray Gun.

Cleaning



**WARNING! TO PREVENT FIRE,
IF A FLAMMABLE SOLVENT
NEEDS TO BE USED,
ADHERE TO THE FOLLOWING:**

- a. Follow solvent manufacturer's clean up instructions and safety precautions.
- b. If collecting flushed solvents in metal container, transfer to nonmetal container, and flush metal container.
- c. Work far away from any ignition sources in a vapor free area.
- d. Keep class ABC fire extinguisher nearby.

Solvent Selection

Follow the material and solvent manufacturer's recommendations for cleaning, solvent type, and disposal.

IMPORTANT: Do not use mineral spirits with latex paints, doing so will make the paint very difficult to remove.



NOTICE

Clean the Spray Gun IMMEDIATELY after EVERY use.
Delayed or inadequate cleaning will permanently clog the Spray Gun.
Latex paint hardens quickly and permanently inside Spray Gun.

After Every Use

Note: Do not immerse Spray Gun Body in solvent or any liquid.

1. Unplug the Spray Gun from its electrical outlet.
2. Use solvent recommended by material manufacturer.
3. Remove the Container.
4. Remove the Suction Tube from the Pump Housing.
5. Carefully empty material out of Container. Dispose of excess material properly, then clean Container and Suction Tube with solvent.
6. Replace the Suction Tube, fill the Container with solvent, then replace the Container.
7. Plug the Spray Gun into an electrical outlet.
8. Spray the solvent through the Spray Gun into a spent solvent container, while shaking the Spray Gun. Once the Container is empty, repeat the process until the solvent comes out clean.
9. Remove the Nozzle and soak it in solvent until it is clean. Use toothpick to remove any residual material, then rinse in warm water.

10. If switching from oil-based to water-based material, after cleaning with solvent, repeat steps 3. through 9. with warm soapy water.
11. Unplug the Spray Gun from its electrical outlet.
12. Remove the Container and Suction Tube, rinse with warm water, then thoroughly dry all parts.
13. Use spray gun lubricant as indicated in Figure J.

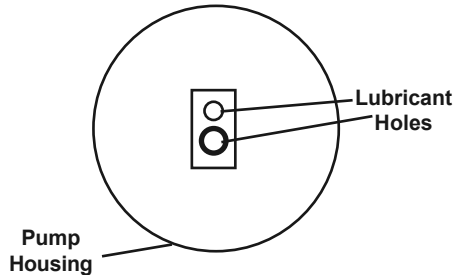

Figure J

14. Reassemble Spray Gun.

NOTICE

Clean the Spray Gun IMMEDIATELY after EVERY use.
Delayed or inadequate cleaning will permanently clog the Spray Gun.
Latex paint hardens quickly and permanently inside Spray Gun.

Nozzle Assembly Cleaning

Note: The Piston, Spring and Cylinder are one piece. Do not disassemble.

1. Remove the Nozzle, and then pull out the Nozzle assembly.
2. Soak all parts in solvent. If necessary, use a brush (sold separately) and a toothpick.
3. Make sure all parts are free from residual paint.
4. Rinse with warm water, then thoroughly dry all parts.
5. Apply a few drops of spray gun lubricant to lubricant holes.
6. Reassemble the Spray Gun.

Important: When replacing Nozzle assembly, position the lubricant holes down so they will line up with lubricant hole under Pump Housing.

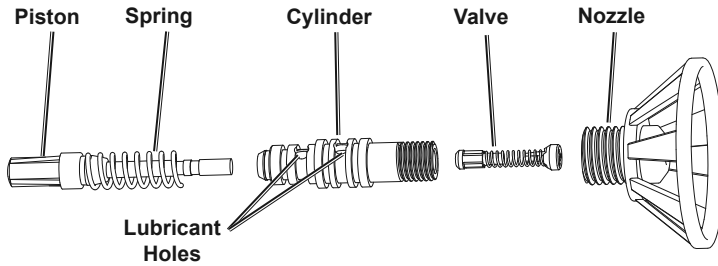

Figure K

Spent Solvent Disposal

After cleaning, dispose of spent solvent according to the solvent manufacturer's directions and local hazardous waste standards.

NOTICE

Clean the Spray Gun IMMEDIATELY after EVERY use.
Delayed or inadequate cleaning will permanently clog the Spray Gun.
Latex paint hardens quickly and permanently inside Spray Gun.

User-Maintenance Instructions



Procedures not specifically explained in this manual must be performed only by a qualified technician.

⚠ WARNING

TO PREVENT SERIOUS INJURY:

Unplug the tool and safely discharge any residual pressure in the tool before performing any inspection, maintenance, or cleaning procedures.

TO PREVENT SERIOUS INJURY FROM TOOL FAILURE:

Do not use damaged equipment. If abnormal noise, vibration, or leaking air occurs, have the problem corrected before further use.

Inspection

BEFORE EACH USE, inspect the general condition of the tool. Check for:

- loose screws,
- misalignment or binding of moving parts,
- clogged nozzle,
- damaged power cord,
- cracked or broken parts, and
- any other condition that may affect its safe operation.

Storage

Store in a dry, secure area out of reach of children.

NOTICE

Clean the Spray Gun IMMEDIATELY after EVERY use.
Delayed or inadequate cleaning will permanently clog the Spray Gun.
Latex paint hardens quickly and permanently inside Spray Gun.

Troubleshooting

When first filled, the gun may take up to 30 seconds after the trigger is held to prime and start spraying.

Problem	Possible Causes	Likely Solutions
Sputtering Spray	<ol style="list-style-type: none">1. Low paint level.2. Container tipped.3. Loose/damaged Nozzle.	<ol style="list-style-type: none">1. Refill.2. Hold upright.3. Replace Nozzle.
Will Not Spray	<ol style="list-style-type: none">1. No power at Spray Gun.2. Fluid too thick.3. Nozzle assembly clogged.	<ol style="list-style-type: none">1. Check Power Cord.2. Thin fluid.3. Clean according to Nozzle Assembly Cleaning section on page 15.
Overspray (Paint drifting to unintended objects.)	<ol style="list-style-type: none">1. Improper application speed.2. Improper distance from workpiece	<ol style="list-style-type: none">1. Move moderately and parallel.2. Adjust distance.
Nozzle Leakage	<ol style="list-style-type: none">1. Dirty Nozzle.2. Worn or damaged Nozzle.	<ol style="list-style-type: none">1. Clean Nozzle.2. Replace Nozzle.
	Follow all safety precautions whenever diagnosing or servicing the tool. Disconnect power cord and safely discharge pressure before service.	

NOTICE

Clean the Spray Gun IMMEDIATELY after EVERY use.
Delayed or inadequate cleaning will permanently clog the Spray Gun.
Latex paint hardens quickly and permanently inside Spray Gun.

PLEASE READ THE FOLLOWING CAREFULLY

THE MANUFACTURER AND/OR DISTRIBUTOR HAS PROVIDED THE PARTS LIST AND ASSEMBLY DIAGRAM IN THIS MANUAL AS A REFERENCE TOOL ONLY. NEITHER THE MANUFACTURER OR DISTRIBUTOR MAKES ANY REPRESENTATION OR WARRANTY OF ANY KIND TO THE BUYER THAT HE OR SHE IS QUALIFIED TO MAKE ANY REPAIRS TO THE PRODUCT, OR THAT HE OR SHE IS QUALIFIED TO REPLACE ANY PARTS OF THE PRODUCT. IN FACT, THE MANUFACTURER AND/OR DISTRIBUTOR EXPRESSLY STATES THAT ALL REPAIRS AND PARTS REPLACEMENTS SHOULD BE UNDERTAKEN BY CERTIFIED AND LICENSED TECHNICIANS, AND NOT BY THE BUYER. THE BUYER ASSUMES ALL RISK AND LIABILITY ARISING OUT OF HIS OR HER REPAIRS TO THE ORIGINAL PRODUCT OR REPLACEMENT PARTS THERETO, OR ARISING OUT OF HIS OR HER INSTALLATION OF REPLACEMENT PARTS THERETO.

Record Product's Serial Number Here: _____

Note: If product has no serial number, record month and year of purchase instead.

Note: Some parts are listed and shown for illustration purposes only, and are not available individually as replacement parts.

NOTICE

Clean the Spray Gun IMMEDIATELY after EVERY use.
Delayed or inadequate cleaning will permanently clog the Spray Gun.
Latex paint hardens quickly and permanently inside Spray Gun.

Parts List and Diagram

Part	Description	Qty	Part	Description	Qty	Part	Description	Qty
1	Nozzle Guard	1	12	Screw	3	23	Power Cord	1
2	Nozzle	1	13	Bumper 2	1	24	Cord Bushing	1
3	Valve Assembly	1	14	Bumper Cover	1	25	Heat Shrink Tube	1
4	Pump Assembly	1	15	Bumper 3	1	26	Terminal	1
5	Cotter Pin	1	16	Regulator Screw	1	27	Bumper Pad	4
6	Motor Assembly	1	17	Regulator Index	1	28	Switch	1
7	Cotter Pin	1	18	Regulator	1	29	Trigger	1
8	Pump Housing	1	19	Container	1	30	Clip	1
9	Motor Bracket	2	20	Gasket	1	31	Right Housing	1
10	Left Housing	1	21	Filter	1	32	Screw	7
11	Cord Clamp	1	22	Suction Tube	1			

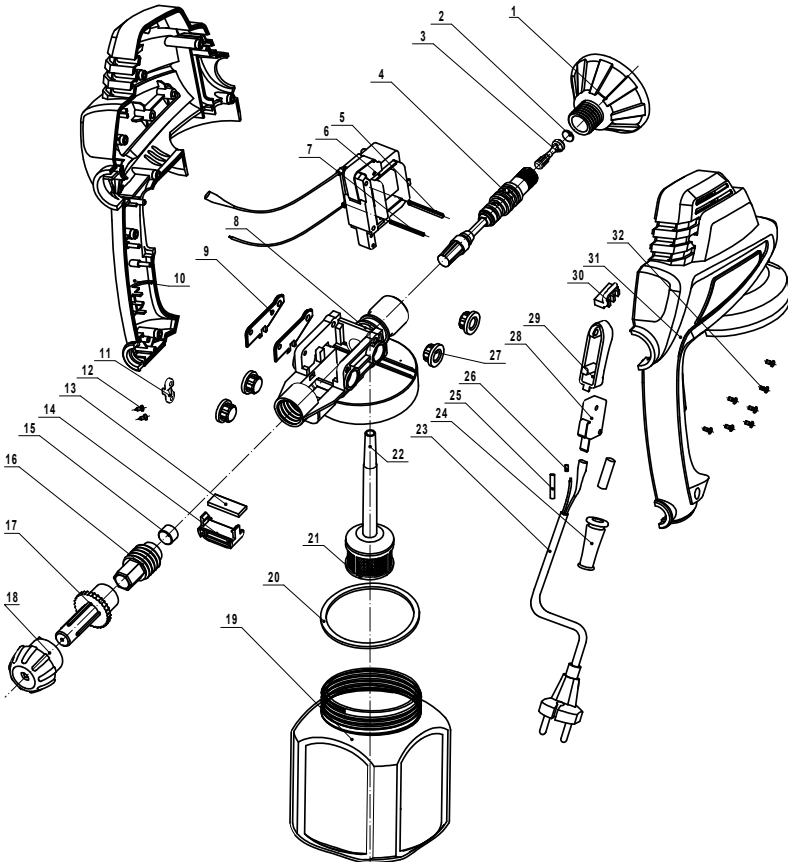

SAFETY

OPERATION

CLEANING

MAINTENANCE

Limited 90 Day Warranty

Harbor Freight Tools Co. makes every effort to assure that its products meet high quality and durability standards, and warrants to the original purchaser that this product is free from defects in materials and workmanship for the period of 90 days from the date of purchase. This warranty does not apply to damage due directly or indirectly, to misuse, abuse, negligence or accidents, repairs or alterations outside our facilities, criminal activity, improper installation, normal wear and tear, or to lack of maintenance. We shall in no event be liable for death, injuries to persons or property, or for incidental, contingent, special or consequential damages arising from the use of our product. Some states do not allow the exclusion or limitation of incidental or consequential damages, so the above limitation of exclusion may not apply to you. THIS WARRANTY IS EXPRESSLY IN LIEU OF ALL OTHER WARRANTIES, EXPRESS OR IMPLIED, INCLUDING THE WARRANTIES OF MERCHANTABILITY AND FITNESS.

To take advantage of this warranty, the product or part must be returned to us with transportation charges prepaid. Proof of purchase date and an explanation of the complaint must accompany the merchandise. If our inspection verifies the defect, we will either repair or replace the product at our election or we may elect to refund the purchase price if we cannot readily and quickly provide you with a replacement. We will return repaired products at our expense, but if we determine there is no defect, or that the defect resulted from causes not within the scope of our warranty, then you must bear the cost of returning the product.

This warranty gives you specific legal rights and you may also have other rights which vary from state to state.

