

# Owner's Manual & Safety Instructions

**Save This Manual** Keep this manual for the safety warnings and precautions, assembly, operating, inspection, maintenance and cleaning procedures. Write the product's serial number in the back of the manual near the assembly diagram (or month and year of purchase if product has no number). Keep this manual and the receipt in a safe and dry place for future reference.

201

# CENTRALPNEUMATIC®

## portable soda blaster



60801 Shown

Visit our website at: <http://www.harborfreight.com>  
Email our technical support at: [productsupport@harborfreight.com](mailto:productsupport@harborfreight.com)

**60801 60802**

When unpacking, make sure that the product is intact and undamaged. If any parts are missing or broken, please call 1-888-866-5797 as soon as possible.

Copyright© 2020 by Harbor Freight Tools®. All rights reserved.  
No portion of this manual or any artwork contained herein may be reproduced in any shape or form without the express written consent of Harbor Freight Tools. Diagrams within this manual may not be drawn proportionally. Due to continuing improvements, actual product may differ slightly from the product described herein.  
Tools required for assembly and service may not be included.

## **⚠ WARNING**





Read this material before using this product.  
Failure to do so can result in serious injury.  
**SAVE THIS MANUAL.**

# Table of Contents

Safety .....	2	Maintenance .....	10
Specifications .....	6	Parts List and Diagram .....	11
Setup .....	7	Warranty .....	12
Operation.....	8		

# CENTRALPNEUMATIC®

## WARNING SYMBOLS AND DEFINITIONS

	This is the safety alert symbol. It is used to alert you to potential personal injury hazards. Obey all safety messages that follow this symbol to avoid possible injury or death.
	Indicates a hazardous situation which, if not avoided, will result in death or serious injury.
	Indicates a hazardous situation which, if not avoided, could result in death or serious injury.
	Indicates a hazardous situation which, if not avoided, could result in minor or moderate injury.
	Addresses practices not related to personal injury.

## IMPORTANT SAFETY INSTRUCTIONS

### INSTRUCTIONS PERTAINING TO A RISK OF FIRE, ELECTRIC SHOCK, OR INJURY TO PERSONS

**WARNING** – When using tools, basic precautions should always be followed, including the following:

#### General

To reduce the risks of electric shock, fire, and injury to persons, read all the instructions before using the tool.

#### Work Area

1. **Keep the work area clean and well lighted.**  
Cluttered benches and dark areas increase the risks of electric shock, fire, and injury to persons.
2. **Do not operate the tool in explosive atmospheres, such as in the presence of flammable liquids, gases, or dust.**  
The tool is able to create sparks resulting in the ignition of the dust or fumes.
3. **Keep bystanders, children, and visitors away while operating the tool.** Distractions are able to result in the loss of control of the tool.

# Personal Safety

1. **Stay alert. Watch what you are doing and use common sense when operating the tool. Do not use the tool while tired or under the influence of drugs, alcohol, or medication.**  
A moment of inattention while operating the tool increases the risk of injury to persons.
2. **Dress properly. Do not wear loose clothing or jewelry. Contain long hair. Keep hair, clothing, and gloves away from moving parts.** Loose clothes, jewelry, or long hair increases the risk of injury to persons as a result of being caught in moving parts.
3. **Avoid unintentional starting. Be sure the switch is off before connecting to the air supply.**  
Do not carry the tool with your finger on the switch or connect the tool to the air supply with the switch on.

4. **Do not overreach. Keep proper footing and balance at all times.**  
Proper footing and balance enables better control of the tool in unexpected situations.
5.  **Use safety equipment.**  
A dust mask, non-skid safety shoes and a hard hat must be used for the applicable conditions.
6.  **Always wear eye protection.**  
Wear ANSI-approved safety goggles.
7.  **Always wear hearing protection when using the tool.**  
Prolonged exposure to high intensity noise is able to cause hearing loss.
8. **Wear heavy-duty work gloves during use.**

# Tool Use and Care

1. **Use clamps or another practical way to secure and support the workpiece to a stable platform.**  
Holding the work by hand or against the body is unstable and is able to lead to loss of control.
2. **Do not force the tool.** Use the correct tool for the application. The correct tool will do the job better and safer at the rate for which the tool is designed.
3. **Do not use the tool if the switch does not turn the tool on or off.** Any tool that cannot be controlled with the switch is dangerous and must be repaired.
4. **Disconnect the tool from the air source before making any adjustments, changing accessories, or storing the tool.** Such preventive safety measures reduce the risk of starting the tool unintentionally. Turn off and detach the air supply, safely discharge any residual air pressure, and release the throttle and/or turn the switch to its off position before leaving the work area.
5. **Store the tool when it is idle out of reach of children and other untrained persons.**  
A tool is dangerous in the hands of untrained users.
6. **Maintain the tool with care.**  
A properly maintained tool is easier to control.
7. **Check for misalignment or binding of moving parts, breakage of parts, and any other condition that affects the tool's operation.** If damaged, have the tool serviced before using. Many accidents are caused by poorly maintained tools. There is a risk of bursting if the tool is damaged.
8. **Use only accessories that are identified by the manufacturer for the specific tool model.** Use of an accessory not intended for use with the specific tool model, increases the risk of injury to persons.

# Service

1. **Tool service must be performed only by qualified repair personnel.**
2. **When servicing a tool, use only identical replacement parts. Use only authorized parts.**
3. **Use only the lubricants supplied with the tool or specified by the manufacturer.**  
Do not use any lubricants with this tool.

# Air Source

- 





**Never connect to an air source that is capable of exceeding 200 psi.** Over pressurizing the tool may cause bursting, abnormal operation, breakage of the tool or serious injury to persons. Use only clean, dry, regulated compressed air at the rated pressure or within the rated pressure range as marked on the tool. Always verify prior to using the tool that the air source has been adjusted to the rated air pressure or within the rated air-pressure range.
- Never use oxygen, carbon dioxide, combustible gases or any bottled gas as an air source for the tool.** Such gases are capable of explosion and serious injury to persons.



**SAVE THESE INSTRUCTIONS.**

## Symbols and Specific Safety Instructions

### Symbol Definitions

Symbol	Property or statement	Symbol	Property or statement
<b>PSI</b>	Pounds per square inch of pressure		WARNING marking concerning Risk of Eye Injury. Wear ANSI-approved eye protection.
<b>CFM</b>	Cubic Feet per Minute flow		WARNING marking concerning Risk of Hearing Loss. Wear hearing protection.
<b>SCFM</b>	Cubic Feet per Minute flow at standard conditions		WARNING marking concerning Risk of Respiratory Injury. Wear NIOSH-approved dust mask/respirator.
<b>NPT</b>	National pipe thread, tapered		WARNING marking concerning Risk of Explosion.
<b>NPS</b>	National pipe thread, straight		

### Specific Safety Instructions

- The warnings and precautions discussed in this manual cannot cover all possible conditions and situations that may occur. It must be understood by the operator that common sense and caution are factors which cannot be built into this product, but must be supplied by the operator.
- DO NOT DROP TANK, RISK OF EXPLOSION.**
- Attach all accessories properly to the Soda Blaster before connecting the air supply. A loose accessory may detach or break during operation.
- Obey the manual for the air compressor used to power this Soda Blaster.
- Install an in-line shutoff valve to allow immediate control over the air supply in an emergency, even if a hose is ruptured.

# Silicosis and Aluminum Oxide Warnings

**WARNING!** Abrasive blasting with sand containing crystalline silica can cause serious or fatal respiratory disease. Exposure to crystalline silica may cause silicosis (a serious lung disease), cancer and death. Exposure to aluminum oxide (a dust generated from material removing processes) can result in eye, skin and breathing irritation. Always use a NIOSH (National Institute for Occupational Safety and Health) approved respirator and safety goggles. Avoid skin exposure. Proper ventilation in the work area is required. Read and understand the 10 recommended measures below to reduce crystalline silica exposures in the workplace and prevent silicosis and silicosis related deaths.

**NIOSH recommends the following measures to reduce crystalline silica exposures in the workplace and prevent silicosis and silicosis-related deaths:**

1. Prohibit silica sand (or other substances containing more than 1% crystalline silica) as an abrasive blasting material and substitute less hazardous materials.
2. Conduct air monitoring to measure worker exposures.

3. Use containment methods such as blast-cleaning machines and cabinets to control the hazard and protect adjacent workers from exposure.
4. Practice good personal hygiene to avoid unnecessary exposure to silica dust.
5. Wear washable or disposable protective clothes at the work site. Shower and change into clean clothes before leaving the work site to prevent contamination of cars, homes and other work areas.
6. Use respiratory protection when source controls cannot keep silica exposures below the NIOSH REL.
7. Provide periodic medical examinations for all workers who may be exposed to crystalline silica.
8. Post signs to warn workers about the hazard and to inform them about required protective equipment.
9. Provide workers with training that includes information about health effects, work practices and protective equipment for crystalline silica.
10. Report all cases of silicosis to State health departments and to OSHA or the Mine Safety and Health Administration (MSHA).

## Vibration Precautions

This tool vibrates during use. Repeated or long-term exposure to vibration may cause temporary or permanent physical injury, particularly to the hands, arms and shoulders. To reduce the risk of vibration-related injury:

1. Anyone using vibrating tools regularly or for an extended period should first be examined by a doctor and then have regular medical check-ups to ensure medical problems are not being caused or worsened from use. Pregnant women or people who have impaired blood circulation to the hand, past hand injuries, nervous system disorders, diabetes, or Raynaud's Disease should not use this tool. If you feel any symptoms related to vibration (such as tingling, numbness, and white or blue fingers), seek medical advice as soon as possible.

2. Do not smoke during use. Nicotine reduces the blood supply to the hands and fingers, increasing the risk of vibration-related injury.
3. Wear suitable gloves to reduce the vibration effects on the user.
4. Use tools with the lowest vibration when there is a choice.
5. Include vibration-free periods each day of work.
6. Grip tool as lightly as possible (while still keeping safe control of it). Let the tool do the work.
7. To reduce vibration, maintain tool as explained in this manual. If abnormal vibration occurs, stop immediately.



**SAVE THESE INSTRUCTIONS.**

# Functional Description

## Specifications

ITEM	60801	60802
Maximum Air Pressure	90 PSI	
Air Inlet	1/4" -18 NPT	
Average Air Consumption	8.5 CFM @ 90 PSI	7 CFM @ 90 PSI
Abrasive Capacity	40 lb.	15 lb.
Abrasive Type	Sodium Bicarbonate media <u>only</u>	

## Components and Controls

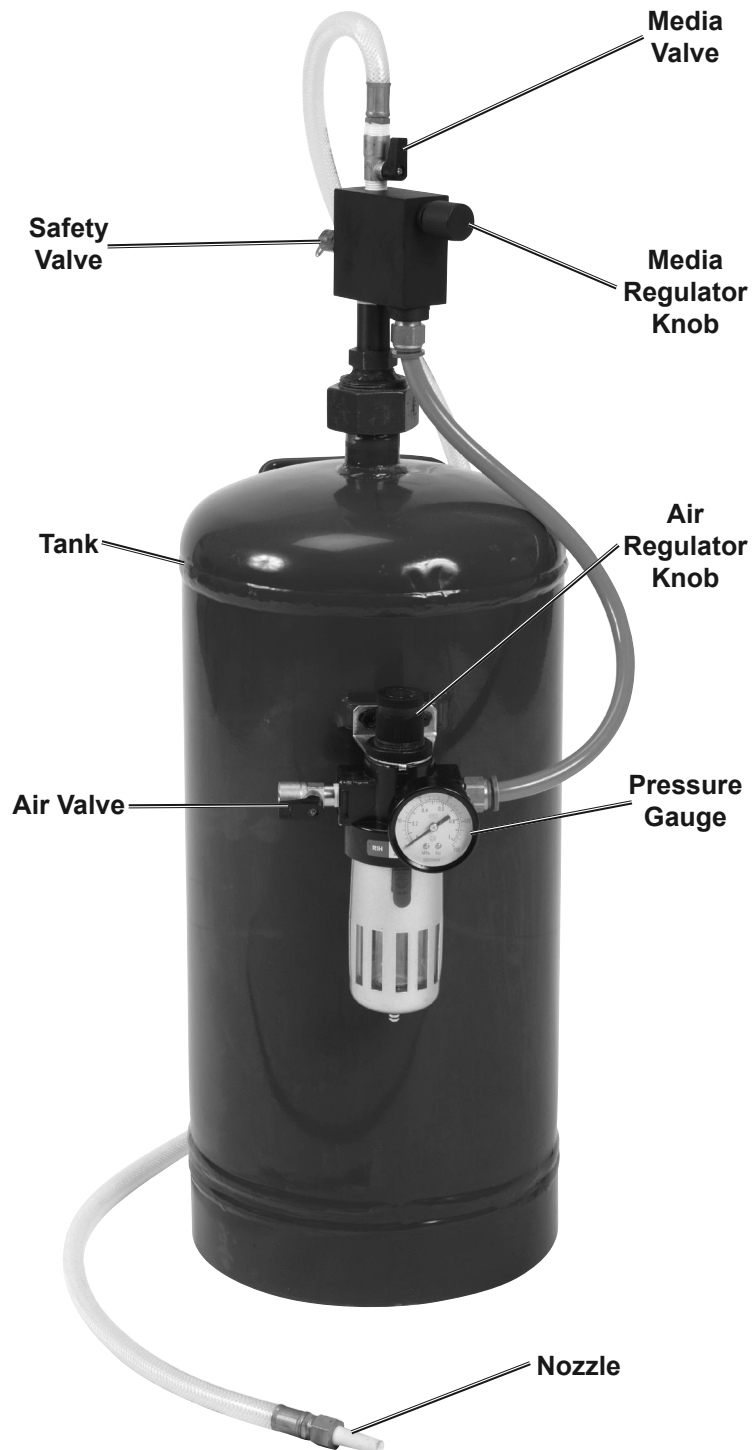

SAFETY

SETUP

OPERATION

MAINTENANCE

# Initial Soda Blaster Set Up/Assembly



Read the **ENTIRE IMPORTANT SAFETY INFORMATION** section at the beginning of this manual including all text under subheadings therein before set up or use of this product.

**Note:** For additional information regarding the parts listed in the following pages, refer to the Assembly Diagram near the end of this manual.

## Assembly

1. Wrap the threads of the Pressure Gauge (7) with thread sealer tape (not included). Screw the Pressure Gauge into the opening in the face of the Air Regulator (9). Tighten using a wrench on the back of the Gauge block. **Do not overtighten.**
2. Attach Bracket (3) to the Tank (1) using the two Socket Head Screws (4) and wrench tighten.
3. Remove the Compression Nut (2) from the Air Regulator (9).
4. Insert the knob on the top of the Air Regulator (9) through the Bracket (3).
5. Align the tab on the Bracket with the recess at gauge side of the Regulator, attach Compression Nut (2), and finger tighten until snug.

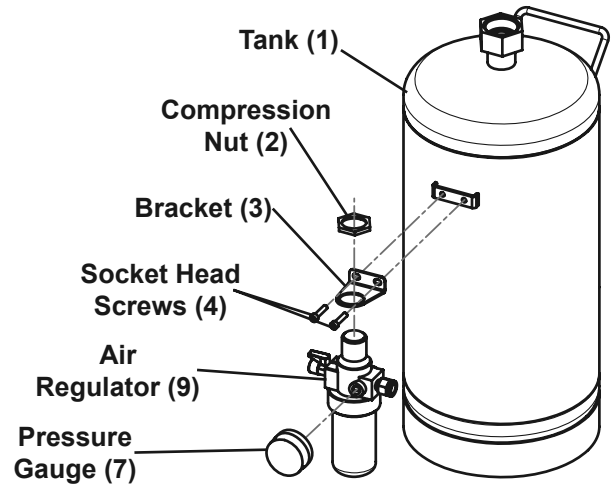

Figure A: Air Regulator Assembly

## Air Supply

### ⚠ WARNING



#### TO PREVENT SERIOUS INJURY FROM EXPLOSION:

Use only clean, dry, regulated, compressed air to power this Soda Blaster. Do not use oxygen, carbon dioxide, combustible gases, or any other bottled gas as a power source for this Soda Blaster.

1. Incorporate a filter, regulator with pressure gauge, dryer, in-line shutoff valve, and quick coupler for best service. **An in-line shutoff ball valve is an important safety device because it controls the air supply even if the air hose is ruptured. The shutoff valve should be a ball valve because it can be closed quickly.**
2. Attach an air hose to the compressor's air outlet. Connect the air hose to the air valve of the Soda Blaster. Other components, such as a coupler plug and quick coupler, will make operation more efficient, but are not required.
3. Close the Soda Blaster's valves.
4. Close the in-line shutoff valve between the compressor and the Soda Blaster.
5. Turn on the air compressor according to the manufacturer's directions and allow it to build up pressure until it cycles off.
6. Adjust the air compressor's output regulator so that the air output is enough to properly power the Soda Blaster, but the output will not exceed the Soda Blaster's maximum air pressure at any time. Adjust the pressure gradually, while checking the air output gauge to set the right pressure range.
7. Inspect the air connections for leaks. Repair any leaks found.
8. If the Soda Blaster will not be used at this time, turn off and detach the air supply, safely discharge any residual air pressure, and close the valves to prevent accidental operation.

**Note:** An oiler system should not be used with this Soda Blaster. The oil will mix with the material being propelled, causing poor results.

**Note:** Air flow, and therefore Soda Blaster performance, can be hindered by undersized air supply components. The air hose must be long enough to reach the work area with enough extra length to allow free movement while working.

# Operating Instructions



Read the **ENTIRE IMPORTANT SAFETY INFORMATION** section at the beginning of this manual including all text under subheadings therein before set up or use of this product.

Inspect Soda Blaster before use, looking for damaged, loose, and missing parts. If any problems are found, do not use Soda Blaster until repaired.

## Tool Set Up - Loading Abrasive

### **WARNING**

**TO PREVENT SERIOUS INJURY FROM ACCIDENTAL OPERATION:**

Close all Valves, detach the air supply, safely discharge any residual air pressure in the Soda Blaster, and close all Valves again before performing any procedure in this section.

**TO PREVENT SERIOUS INJURY:**

Do not adjust or tamper with any control or component in a way not specifically explained within this manual. Improper adjustment can result in Soda Blaster failure or other serious hazards.

### Use sodium bicarbonate blast media only.

**WARNING!** Do not use sand or other blasting materials that contain crystalline silica.

**Note:** Use only dry and clean abrasives to avoid clogging the Soda Blaster.

**Note:** The Nozzle size depends on grit of media used. Change the nozzle as needed to suit the abrasive.

1. Pull back on the blue Air Hose Connector (8) collar and pull out Air Hose (15).
2. Hold collar on Tank (1) with a wrench and use another wrench to loosen Bushing (10). (Wrenches not included.)
3. Remove entire media discharge assembly slowly, being careful with the Pickup Tube (11) as it may contain residual media which can spill when removed. Allow time for the trapped aggregate to safely discharge back into the Tank.
4. Using a funnel, pour media into the Tank.

**Note:** If this is a large job, fill the Tank only 3/4 full and reload as needed to finish the job.

**Note:** If the humidity is 90 to 100%, reduce the amount of media and refill more frequently to reduce clogging.

5. Inspect condition of the O-ring (19) at the bottom of the Bushing, and replace if damaged.
6. Insert the Pickup Tube into the Tank and tighten the Bushing. **Do not over tighten.**
7. Pull back on the blue Air Hose Connector collar and insert the Air Hose deep into the fitting. Release the collar.

**Note:** If air leaks around the Air Hose, remove it, cut approximately a quarter of an inch off and reattach it.

8. Turn on the compressor and set the regulator to the pressure recommended for this Soda Blaster (90 PSI).

**CAUTION!** Do not exceed 90 PSI.



# Workpiece and Work Area Set Up

1. Designate a work area that is clean and well-lit. The work area must not allow access by children or pets to prevent distraction and injury.
2. Route the air hose along a safe route to reach the work area without creating a tripping hazard or exposing the air hose to possible damage. The air hose must be long enough to reach the work area with enough extra length to allow free movement while working.
3. Secure loose workpieces using a vise or clamps (not included) to prevent movement while working.
4. There must not be hazardous objects (such as utility lines or foreign objects) nearby that will present a hazard while working.

## General Operating Instructions

1. If possible, place the workpiece inside a sandblast cabinet. Otherwise, isolate the workpiece to make sure no damage can occur to nearby personal property.
2. Open the Air Valve.
3. Grip the Media Hose and Nozzle firmly, and point them at the start point. Open the Media Valve completely to release the media.  
**NOTICE:** To prevent damage, only use the Media Valve to turn the flow on or off. Do not use it to adjust the flow rate. Only use the Media Regulator Knob to adjust the flow rate.
4. Spray the abrasive media onto the work material, moving the Nozzle from side to side.  
**NOTE:** The flow rate of the media may be irregular when first started. Provided the media is dry, the flow rate will normalize in approximately one minute.
5. Use Media Regulator Knob to adjust the media flow rate.
6. Adjust the Air Regulator to adjust the air flow and pressure. Do not set the pressure higher than 90 PSI.
7. If the Soda Blaster requires more force to accomplish the task, verify that the Soda Blaster receives sufficient, unobstructed airflow (CFM) and increase the pressure (PSI) output of the regulator up to the maximum air pressure rating of this Soda Blaster.  
**CAUTION! TO PREVENT SODA BLASTER AND ACCESSORY FAILURE, RESULTING IN INJURY: Do not exceed the Soda Blaster's maximum air pressure rating.**  
If the Soda Blaster still does not have sufficient force at maximum pressure and sufficient airflow, then a larger Soda Blaster may be required.
8. If excessive air pressure is used, or Media Regulator becomes clogged, the Safety Valve may open, releasing air pressure. To correct:
  - a. Shut OFF Air Valve.
  - b. Adjust Air Regulator to below 90 PSI.
  - c. Turn the Air Valve back on.
  - d. If the problem happens again, detach the air supply and clean out the Media Regulator and Media Hose.
9. To prevent accidents, close the Valves on the Soda Blaster, detach the air supply, safely discharge any residual air pressure in the Soda Blaster, and close the Valves again. Empty the Tank, and clean external surfaces of the Soda Blaster with clean, dry cloth. Then store the Soda Blaster indoors out of children's reach.

# CENTRALPNEUMATIC®

# User-Maintenance Instructions



Procedures not specifically explained in this manual must be performed only by a qualified technician.

## ⚠️ WARNING

### TO PREVENT SERIOUS INJURY FROM ACCIDENTAL OPERATION:

Turn off the Soda Blaster, detach the air supply, safely discharge any residual air pressure in the Soda Blaster, and release the throttle and/or turn the switch to its off position before performing any inspection, maintenance, or cleaning procedures.

### TO PREVENT SERIOUS INJURY FROM SODA BLASTER FAILURE:

Do not use damaged equipment. If abnormal noise, vibration, or leaking air occurs, have the problem corrected before further use.

## Cleaning, Maintenance, and Lubrication

**Note:** These procedures are in addition to the regular checks and maintenance explained as part of the regular operation of the air-operated Soda Blaster.

- BEFORE EACH USE**, inspect the general condition of the Soda Blaster. Check for:
  - loose hardware or housing,
  - misalignment or binding of moving parts,
  - cracked or broken parts, and
  - any other condition that may affect its safe operation.
- Daily - Air Supply Maintenance:**  
Every day, maintain the air supply according to the component manufacturers' instructions. Drain the moisture filter regularly. Performing routine air supply maintenance will allow the Soda Blaster to operate more safely and will also reduce wear on the Soda Blaster.

## Troubleshooting

- Excess moisture will cause the abrasive to slow or stop flowing through the Abrasive Outlet Pipe. To test, check the abrasive by pouring a 6" cone of abrasive on dry newspaper. After several minutes, remove the abrasive from the newspaper. Do not use the abrasive if the newspaper is moist.
- Poor or irregular flow of the abrasive may also be due to low air pressure or a worn Nozzle. To correct, increase the air pressure (to no more than 90 PSI) and/or replace the worn Nozzle.

## PLEASE READ THE FOLLOWING CAREFULLY

THE MANUFACTURER AND/OR DISTRIBUTOR HAS PROVIDED THE PARTS LIST AND ASSEMBLY DIAGRAM IN THIS MANUAL AS A REFERENCE TOOL ONLY. NEITHER THE MANUFACTURER OR DISTRIBUTOR MAKES ANY REPRESENTATION OR WARRANTY OF ANY KIND TO THE BUYER THAT HE OR SHE IS QUALIFIED TO MAKE ANY REPAIRS TO THE PRODUCT, OR THAT HE OR SHE IS QUALIFIED TO REPLACE ANY PARTS OF THE PRODUCT. IN FACT, THE MANUFACTURER AND/OR DISTRIBUTOR EXPRESSLY STATES THAT ALL REPAIRS AND PARTS REPLACEMENTS SHOULD BE UNDERTAKEN BY CERTIFIED AND LICENSED TECHNICIANS, AND NOT BY THE BUYER. THE BUYER ASSUMES ALL RISK AND LIABILITY ARISING OUT OF HIS OR HER REPAIRS TO THE ORIGINAL PRODUCT OR REPLACEMENT PARTS THERETO, OR ARISING OUT OF HIS OR HER INSTALLATION OF REPLACEMENT PARTS THERETO.

# Parts List and Diagram

Part	Description	Qty
1	Tank	1
2	Compression Nut	1
3	Bracket	1
4	Socket Head Screw	2
5	Male Coupler	1
6	Air Valve	1
7	Pressure Gauge	1
8	Air Hose Connector	2
9	Air Regulator	1
10	Bushing	1

Part	Description	Qty
11	Pickup Tube	1
12	Media Valve	1
13	Media Regulator Asm.	1
14	Safety Valve	1
15	Air Hose	1
16	Media Hose	1
17	Nozzle Capnut	1
18	Ceramic Nozzle	1
19	O-Ring	1

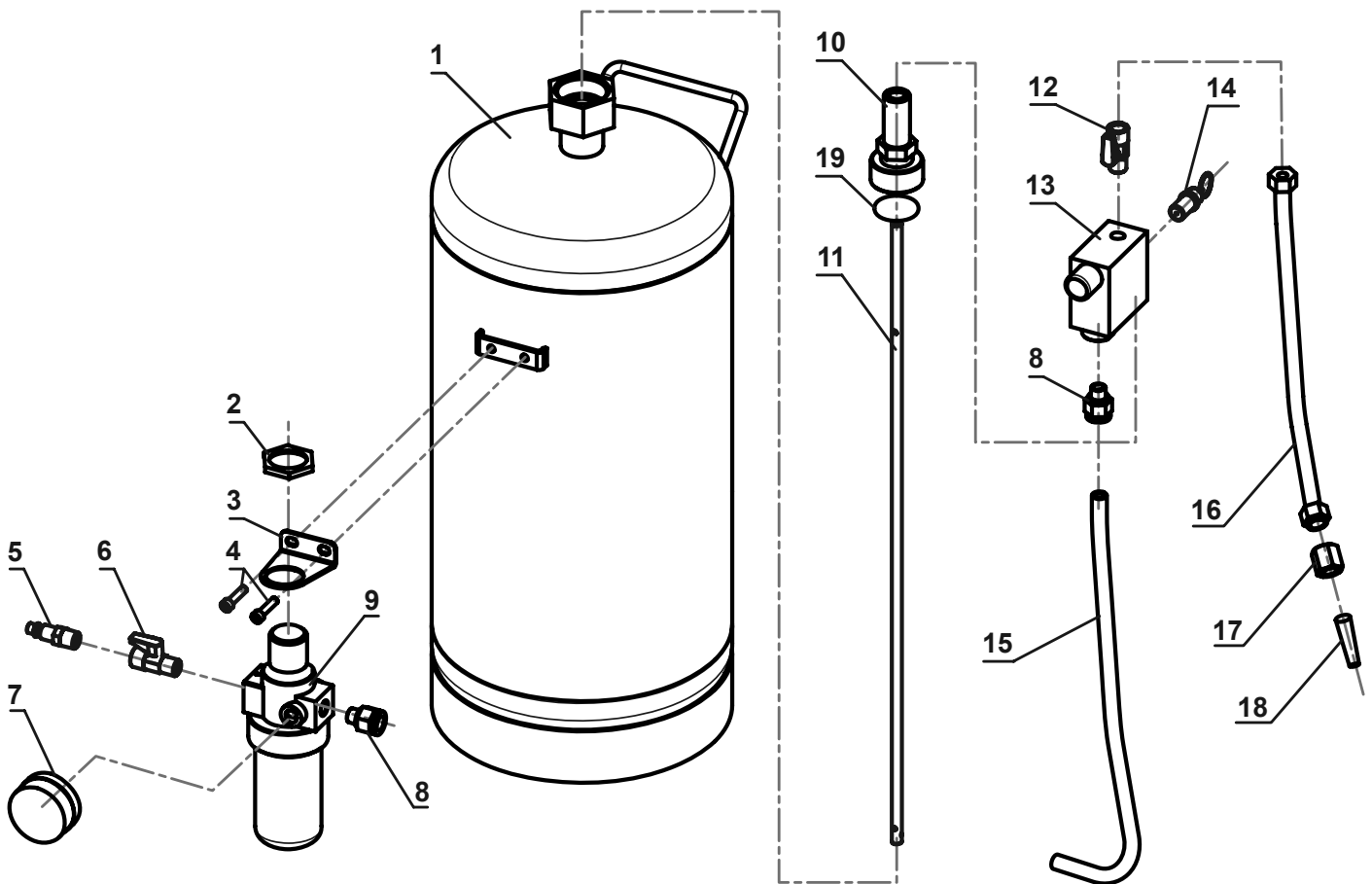

Record Product's Serial Number Here: \_\_\_\_\_

**Note:** If product has no serial number, record month and year of purchase instead.

**Note:** Some parts are listed and shown for illustration purposes only, and are not available individually as replacement parts. Parts may not be interchangeable. Specify UPC number when ordering:

40 lb. (60801): 792363608015

15 lb. (60802): 792363608022

## LIMITED 90 DAY WARRANTY

Harbor Freight Tools Co. makes every effort to assure that its products meet high quality and durability standards, and warrants to the original purchaser that this product is free from defects in materials and workmanship for the period of 90 days from the date of purchase. This warranty does not apply to damage due directly or indirectly, to misuse, abuse, negligence or accidents, repairs or alterations outside our facilities, criminal activity, improper installation, normal wear and tear, or to lack of maintenance. We shall in no event be liable for death, injuries to persons or property, or for incidental, contingent, special or consequential damages arising from the use of our product. Some states do not allow the exclusion or limitation of incidental or consequential damages, so the above limitation of exclusion may not apply to you. THIS WARRANTY IS EXPRESSLY IN LIEU OF ALL OTHER WARRANTIES, EXPRESS OR IMPLIED, INCLUDING THE WARRANTIES OF MERCHANTABILITY AND FITNESS.

To take advantage of this warranty, the product or part must be returned to us with transportation charges prepaid. Proof of purchase date and an explanation of the complaint must accompany the merchandise. If our inspection verifies the defect, we will either repair or replace the product at our election or we may elect to refund the purchase price if we cannot readily and quickly provide you with a replacement. We will return repaired products at our expense, but if we determine there is no defect, or that the defect resulted from causes not within the scope of our warranty, then you must bear the cost of returning the product.

This warranty gives you specific legal rights and you may also have other rights which vary from state to state.

# CENTRALPNEUMATIC®

26541 Agoura Road • Calabasas, CA 91302 • 1-888-866-5797