

PREDATOR[®]

ENGINES

QUICK START GUIDE

Horizontal Shaft Gas Engine Item: 60363

Engine Components

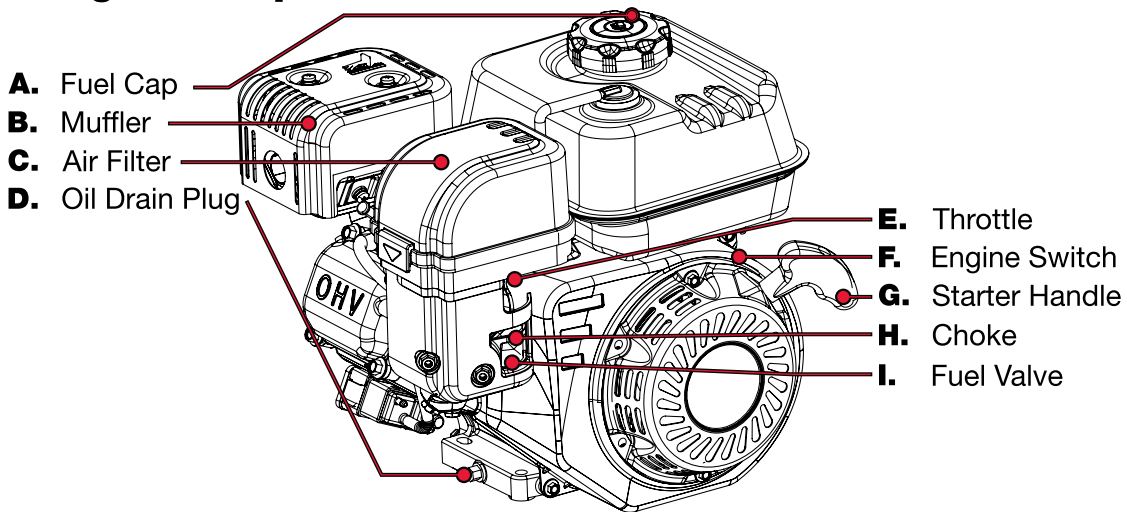

READ AND UNDERSTAND USER MANUAL BEFORE USE.



Add Fluids

Check oil and fuel levels
If needed, fill in as shown below

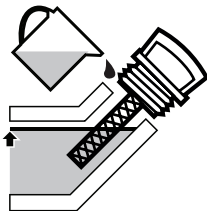

Add oil to engine
crankcase

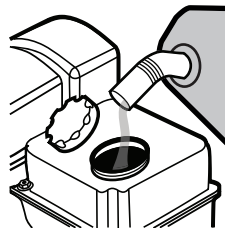

Add fuel to within
1" of the rim of the tank

Note: Use regular Unleaded 87 Octane.
Engine note designed for E85 Ethanol blend.

Assembly

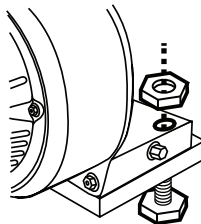

Mount the engine
securely in place

Starting Procedure

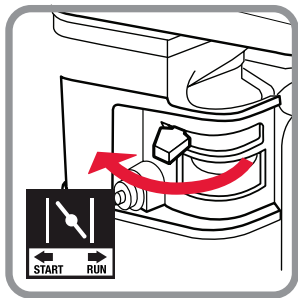

1. CLOSE CHOKE

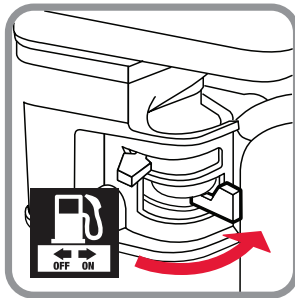

2. OPEN FUEL VALVE

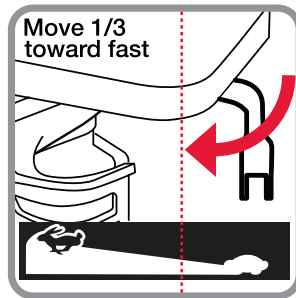

3. ADJUST THROTTLE

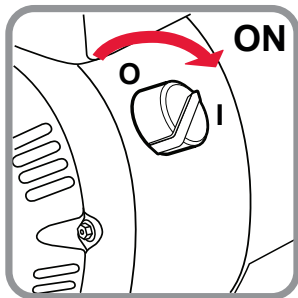

4. SWITCH ON

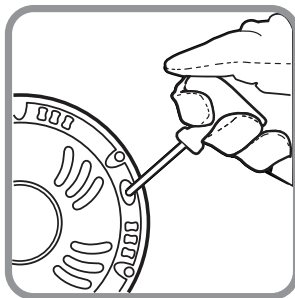

5. PULL START

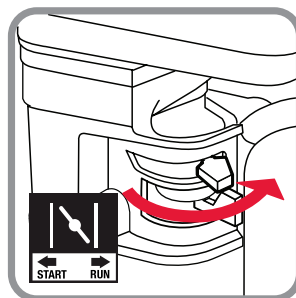

6. CHOKE TO RUN

IMPORTANT: Breaking-in the engine will help to ensure proper equipment and engine performance. The operational break-in period will last about 3 hours of use. During this period: • Do not apply a heavy load. • Do not operate the engine at its maximum speed.



**Visit our website at: <http://www.harborfreight.com>
Email our technical support at: productsupport@harborfreight.com
Email our engine support at: predator@harborfreight.com**

READ AND UNDERSTAND USER MANUAL BEFORE USE.