

Owner's Manual & Safety Instructions

Save This Manual Keep this manual for the safety warnings and precautions, assembly, operating, inspection, maintenance and cleaning procedures. Write the product's serial number in the back of the manual near the assembly diagram (or month and year of purchase if product has no number). Keep this manual and the receipt in a safe and dry place for future reference.

REV 16e

PITTSBURGH[®] AUTOMOTIVE

62234

1250 LB Vehicle Positioning Wheel Dolly



Visit our website at: <http://www.harborfreight.com>
Email our technical support at: productsupport@harborfreight.com





When unpacking, make sure that the product is intact and undamaged. If any parts are missing or broken, please call 1-888-866-5797 as soon as possible.

Copyright© 2014 by Harbor Freight Tools®. All rights reserved.
No portion of this manual or any artwork contained herein may be reproduced in any shape or form without the express written consent of Harbor Freight Tools. Diagrams within this manual may not be drawn proportionally. Due to continuing improvements, actual product may differ slightly from the product described herein.
Tools required for assembly and service may not be included.

⚠ WARNING

**Read this material before using this product.
Failure to do so can result in serious injury.
SAVE THIS MANUAL.**

WARNING SYMBOLS AND DEFINITIONS

	This is the safety alert symbol. It is used to alert you to potential personal injury hazards. Obey all safety messages that follow this symbol to avoid possible injury or death.
	Indicates a hazardous situation which, if not avoided, will result in death or serious injury.
	Indicates a hazardous situation which, if not avoided, could result in death or serious injury.
	Indicates a hazardous situation which, if not avoided, could result in minor or moderate injury.
	Addresses practices not related to personal injury.

IMPORTANT SAFETY INFORMATION

Failure to heed these markings may result in personal injury and/or property damage:

1. Study, understand, and follow all instructions before operating this device.
2. Do not exceed rated capacity.
3. Use only on hard, level surface.
4. Before moving a load, assure that the load is centered and secured with a load restraint device.
5. No alterations shall be made to this product.
6. Wear ANSI-approved safety goggles and heavy-duty work gloves during use.
7. Keep clear of load's path while placing on and removing from dollies, and while moving.
8. Use as intended only. Do not use for aircraft purposes. **Use only in pairs.**
9. Inspect before every use; do not use if parts are loose or damaged.
10. Be aware of dynamic loading! Sudden load movement may briefly create excess load causing product failure.
11. Assemble only according to these instructions. Improper assembly can create hazards.
12. Keep your work area clean and well lit. Cluttered work areas invite accidents.
13. Keep bystanders, children, and visitors away while operating Wheel Dolly. Distractions can cause you to lose control.
14. Stay alert. Watch what you are doing, and use common sense when operating Wheel Dollies. Do not use while tired or under the influence of drugs, alcohol, or medication. A moment of inattention while operating Wheel Dollies may result in serious personal injury.
15. Before use, read manufacturer's instruction manual for the vehicle you will lift.
16. Keep clear of load while lifting and lowering.
17. Do not work under vehicle while on Dollies.
18. Lower load slowly.
19. Weight capacity and other product capabilities apply to properly and completely assembled product only.
20. Store idle Wheel Dollies out of reach of children and other untrained persons. Jacks are dangerous in the hands of untrained users.
21. Wheel Dolly service must be performed only by qualified repair personnel. Service or maintenance performed by unqualified personnel could result in a risk of injury.
22. When servicing a Wheel Dolly, use only identical replacement parts - refer to attached, product-specific parts list and diagram. Follow instructions in the "Inspection, Maintenance, And Cleaning" section of this manual. Use of unauthorized parts or failure to follow maintenance instructions may create a risk of injury and may void any applicable warranty.
23. Industrial applications must follow OSHA requirements.

- 24. Do not allow anyone in the vehicle while using the Wheel Dolly. Do not start the vehicle while it is on Wheel Dollies. Keep all bystanders a safe distance away from the vehicle.
- 25. This product is not a toy. Do not allow children to play with or near this item.
- 26. Maintain product labels and nameplates. These carry important safety information. If unreadable or missing, contact Harbor Freight Tools for a replacement.
- 27. The warnings, precautions, and instructions discussed in this manual cannot cover all possible conditions and situations that may occur. The operator must understand that common sense and caution are factors, which cannot be built into this product, but must be supplied by the operator.
- 28. **Do not roll the seat while loaded over rough surfaces, such as concrete seams.** Use on flat, level, hard surface only. Wheels may scratch or dig into less durable surfaces (such as linoleum or wood).



SAVE THESE INSTRUCTIONS.

Specifications

Rated Capacity	1250 lb
Maximum Tire Width	9"

Setup - Before Use:



Read the **ENTIRE IMPORTANT SAFETY INFORMATION** section at the beginning of this manual including all text under subheadings therein before set up or use of this product.

Note: For additional information regarding the parts listed in the following pages, refer to *Parts List and Assembly Diagram* on page 6.

Functions

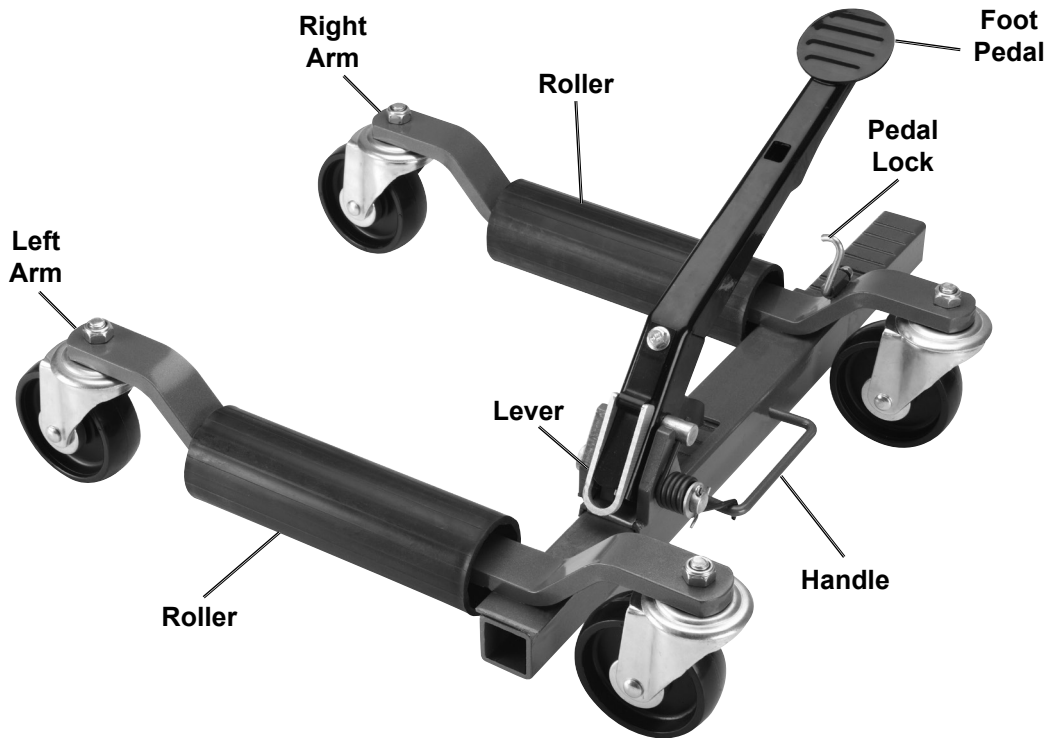

Figure A

Assembly Instructions



Read the **ENTIRE IMPORTANT SAFETY INFORMATION** section at the beginning of this document including all text under subheadings therein before set up or use of this product.

1. Assemble on a flat, level, hard and smooth surface.
2. Attach Casters, making sure the Square Nuts seat inside the Square Openings.
3. Thread Lock Nuts on to Caster bolts, securing tightly.

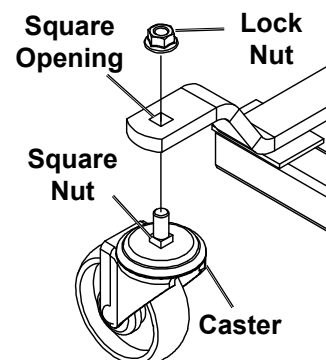

Figure B

Operating Instructions



Read the **ENTIRE IMPORTANT SAFETY INFORMATION** section at the beginning of this manual including all text under subheadings therein before set up or use of this product.

1. Release the Foot Pedal by depressing it and disengaging the Pedal Lock.
2. **Lifting Tire:**
 - a. With the Lever in the down position, roll Dolly in front of tire, spread Arms apart, then push Dolly forward so that Rollers are on either side of tire.
 - b. Move the Lever to the up position, then pump the Foot Pedal until the tire is just lifted off the ground.

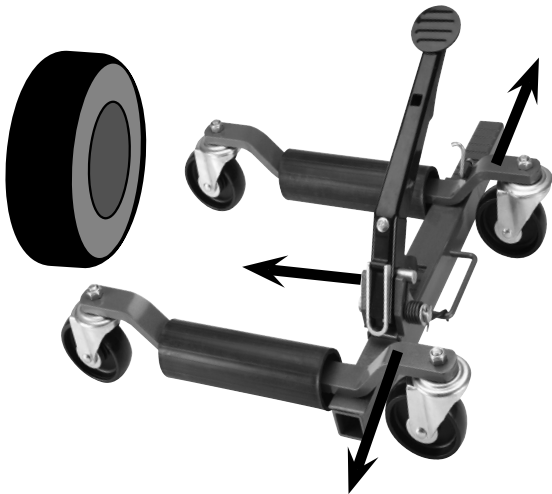

Figure C: Putting Dolly Around Tire
(Lever in Down Position)



Figure D: Lever in Up Position

WARNING! Be ready for any movement the vehicle may make when the other tire(s) come off the ground. Ensure that you have sufficient assistance and manpower to safely guide and control the vehicle.

3. Repeat 2. **Lifting Tire:** for the other tire(s). **Use only in pairs.**

WARNING! Stay clear of any sloping areas or entry ramps, however shallow they may appear. Sufficient space should be allowed between the side of the vehicle and an adjacent wall for the vehicle to be withdrawn from its location in a sideways manner.

4. **Lowering Tire:**
 - a. Move the Lever to the down position, then depress and release the Foot Pedal.
 - b. Once tire is on the ground, spread Arms and remove Dolly.
 - c. Push arms together, then depress Foot Pedal all the way and secure with Pedal Lock.

Inspection, Maintenance, And Cleaning



Procedures not specifically explained in this manual must be performed only by a qualified technician.

WARNING

TO PREVENT SERIOUS INJURY FROM TOOL FAILURE:
Do not use damaged equipment. If abnormal noise or vibration occurs, have the problem corrected before further use.

1. **BEFORE EACH USE**, inspect the general condition of the Wheel Dolly. Check for:
 - broken, cracked, or bent parts,
 - loose or missing parts,
 - and any condition that may affect the proper operation of the product.
2. **AFTER EVERY USE**, wipe with a clean cloth. Then, store the Wheel Dolly in a safe, dry location out of reach of children and other non-authorized people.
3. **PERIODICALLY:**
 - lubricate the Casters and Foot Pedal pivot with oil.
 - put Lever in down position, spread arms apart and lightly grease the notched tube.

PLEASE READ THE FOLLOWING CAREFULLY

THE MANUFACTURER AND/OR DISTRIBUTOR HAS PROVIDED THE PARTS LIST AND ASSEMBLY DIAGRAM IN THIS DOCUMENT AS A REFERENCE TOOL ONLY. NEITHER THE MANUFACTURER OR DISTRIBUTOR MAKES ANY REPRESENTATION OR WARRANTY OF ANY KIND TO THE BUYER THAT HE OR SHE IS QUALIFIED TO MAKE ANY REPAIRS TO THE PRODUCT, OR THAT HE OR SHE IS QUALIFIED TO REPLACE ANY PARTS OF THE PRODUCT. IN FACT, THE MANUFACTURER AND/OR DISTRIBUTOR EXPRESSLY STATES THAT ALL REPAIRS AND PARTS REPLACEMENTS SHOULD BE UNDERTAKEN BY CERTIFIED AND LICENSED TECHNICIANS, AND NOT BY THE BUYER. THE BUYER ASSUMES ALL RISK AND LIABILITY ARISING OUT OF HIS OR HER REPAIRS TO THE ORIGINAL PRODUCT OR REPLACEMENT PARTS THERETO, OR ARISING OUT OF HIS OR HER INSTALLATION OF REPLACEMENT PARTS THERETO.

Parts List and Assembly Diagram

Parts List

Part	Description	Qty
1	Roller	2
2	Screw (4.2x25)	4
3	Roller Bearing	4
4	Lock Nut (M12)	4
5	Caster	4
6	Right Arm	2
7	Lock Nut (M6)	1
8	Rubber Ring	1
9	Pedal Lock	1
10	Retaining Pin 2	1
11	Square Plug	1
12	Pedal	1
13	Front Pawl	1

Part	Description	Qty
14	Spring	1
15	Lever	1
16	Spring Pad	1
17	Screw (M8x22)	1
18	Back Pawl	1
19	Spring	1
20	Plate	1
21	Retainer	1
22	Retaining Pin 1	1
23	Cotter Pin (Ø3x30)	1
24	Washer	2
25	Torsion Spring	1
26	Left Arm	1

Record Serial Number Here:

Note: If product has no serial number, record month and year of purchase instead.

Note: Some parts are listed and shown for illustration purposes only, and are not available individually as replacement parts.

Assembly Diagram

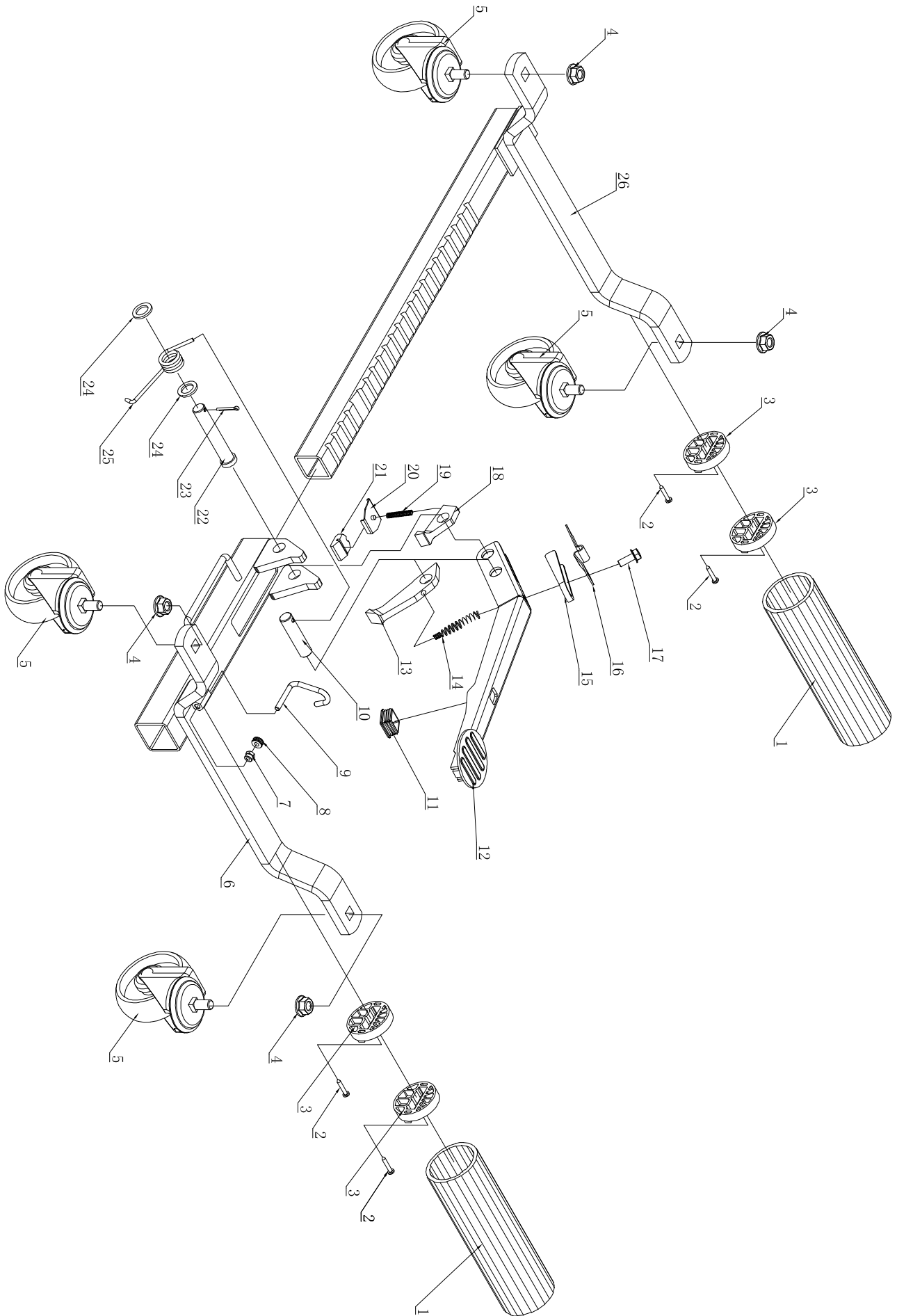

Limited 90 Day Warranty

Harbor Freight Tools Co. makes every effort to assure that its products meet high quality and durability standards, and warrants to the original purchaser that this product is free from defects in materials and workmanship for the period of 90 days from the date of purchase. This warranty does not apply to damage due directly or indirectly, to misuse, abuse, negligence or accidents, repairs or alterations outside our facilities, criminal activity, improper installation, normal wear and tear, or to lack of maintenance. We shall in no event be liable for death, injuries to persons or property, or for incidental, contingent, special or consequential damages arising from the use of our product. Some states do not allow the exclusion or limitation of incidental or consequential damages, so the above limitation of exclusion may not apply to you. THIS WARRANTY IS EXPRESSLY IN LIEU OF ALL OTHER WARRANTIES, EXPRESS OR IMPLIED, INCLUDING THE WARRANTIES OF MERCHANTABILITY AND FITNESS.

To take advantage of this warranty, the product or part must be returned to us with transportation charges prepaid. Proof of purchase date and an explanation of the complaint must accompany the merchandise. If our inspection verifies the defect, we will either repair or replace the product at our election or we may elect to refund the purchase price if we cannot readily and quickly provide you with a replacement. We will return repaired products at our expense, but if we determine there is no defect, or that the defect resulted from causes not within the scope of our warranty, then you must bear the cost of returning the product.

This warranty gives you specific legal rights and you may also have other rights which vary from state to state.

PITTSBURGH[®] **AUTOMOTIVE**

3491 Mission Oaks Blvd. • PO Box 6009 • Camarillo, CA 93011 • 1-888-866-5797