

CENTRAL PNEUMATIC®

QUICK START GUIDE

30 GALLON 14 HP AIR COMPRESSOR

READ AND UNDERSTAND USER MANUAL BEFORE USE

Components

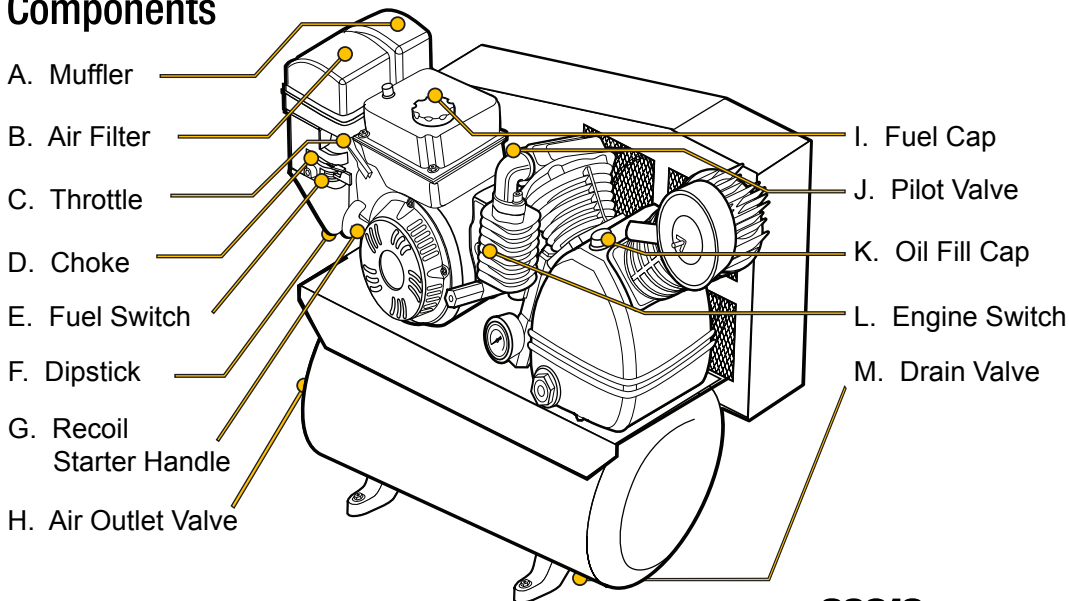

62913



Add Fluids

Check oil and fuel levels.
If needed, fill as shown below.

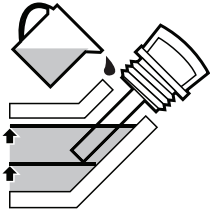

Add oil to engine crankcase

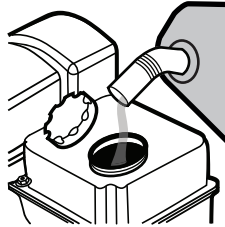

Add fuel to within
1" of the rim of the tank

Note: Use regular Unleaded 87 Octane or better.
Engine not designed for E85 Ethanol blend.

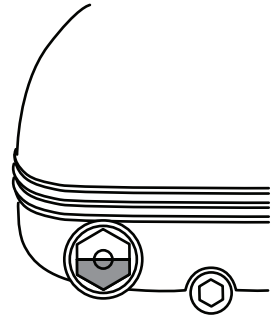

Add oil to pump,
filling to center of sight
glass

Assembly

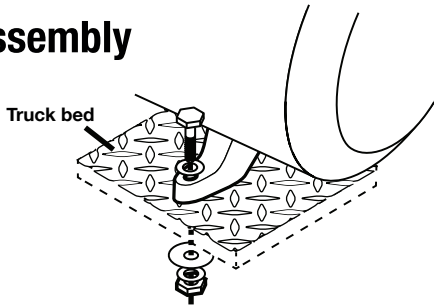

Mount the compressor securely
in place on a flat level surface

For Electric Start

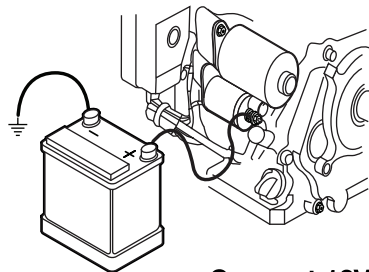

Connect 12V battery

Manual Starting Procedure

CENTRALPNEUMATIC®

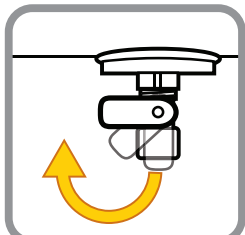

1. CLOSE DRAIN VALVE

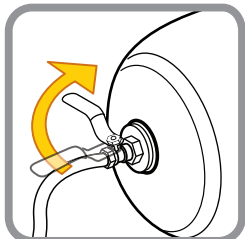

2. CLOSE OUTLET VALVE

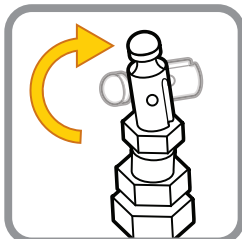

3. OPEN PILOT VALVE



4. OPEN FUEL VALVE

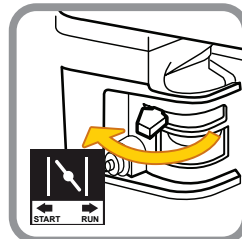

5. CLOSE CHOKE

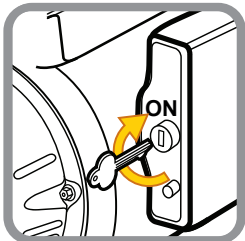

6. SWITCH ON

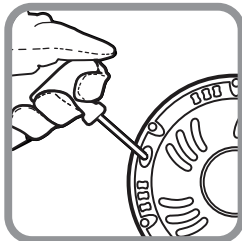

7. PULL CORD



8. CHOKE TO RUN

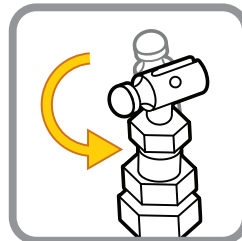

9. CLOSE PILOT VALVE

Electric Starting Procedure

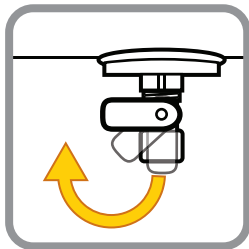

1. CLOSE DRAIN VALVE

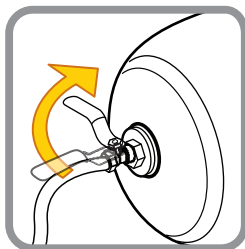

2. CLOSE OUTLET VALVE

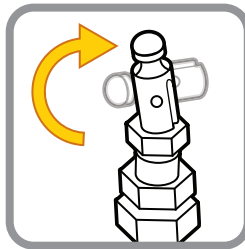

3. OPEN PILOT VALVE

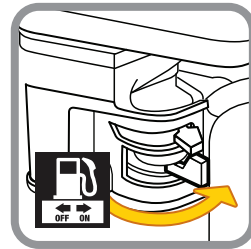

4. OPEN FUEL VALVE



5. CLOSE CHOKE

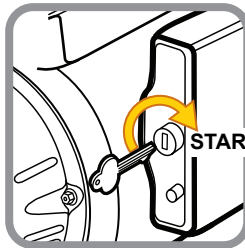

6. TURN TO START



7. CHOKE TO RUN

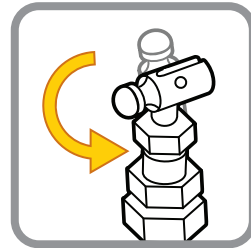

8. CLOSE PILOT VALVE

Visit our website at: <http://www.harborfreight.com>
Email our technical support at: productsupport@harborfreight.com
Email our engine support at: predator@harborfreight.com