

Owner's Manual & Safety Instructions

Save This Manual Keep this manual for the safety warnings and precautions, assembly, operating, inspection, maintenance and cleaning procedures. Write the product's serial number in the back of the manual near the assembly diagram (or month and year of purchase if product has no number). Keep this manual and the receipt in a safe and dry place for future reference.

17e

MADDOX™

SUPERIOR AUTOMOTIVE TOOLS

MB16-1

Slide Hammer and Puller Set



Visit our website at: <http://www.harborfreight.com>
Email our technical support at: productsupport@harborfreight.com

63729

When unpacking, make sure that the product is intact and undamaged. If any parts are missing or broken, please call 1-888-866-5797 as soon as possible.

Copyright© 2017 by Harbor Freight Tools®. All rights reserved.

No portion of this manual or any artwork contained herein may be reproduced in any shape or form without the express written consent of Harbor Freight Tools. Diagrams within this manual may not be drawn proportionally. Due to continuing improvements, actual product may differ slightly from the product described herein. Tools required for assembly and service may not be included.

⚠WARNING

**Read this material before using this product.
Failure to do so can result in serious injury.
SAVE THIS MANUAL.**

Specifications

Hammer Weight	5 lb.
Functions	Internal or external 3-jaw puller Internal or external 2-jaw puller Puller hook Rear axle puller Dent puller Threaded Puller/Wrench Adapter

Important Safety Information

1. Wear ANSI-approved safety goggles and heavy-duty work gloves during assembly and use.
2. Inspect before every use; do not use if parts are damaged.
3. Do not use for aircraft purposes; use as intended only.
4. Do not modify Slide Hammer to perform a task other than what it was designed for. Do not use anything other than the included hammer with this tool.
5. Read vehicle owner's manual and instruction manual for Jack (not included) for proper jacking positions (where applicable) before use.
6. Assemble only according to instructions. Improper assembly can create hazards.
7. This product is not a toy. Do not allow children to play with or near this item.
8. Maintain product labels and nameplates. These carry important safety information. If unreadable or missing, contact Harbor Freight Tools for a replacement.
9. Harbor Freight Tools is not responsible for vehicle damage (including cosmetic damage) due to improper use or lack of experience for using this type of tool.

MADDOX™
SUPERIOR AUTOMOTIVE TOOLS

Instructions



Read the **ENTIRE IMPORTANT SAFETY INFORMATION** section at the beginning of this document including all text under subheadings therein before set up or use of this product.

Assembly

1. Slide the plain end of the Slide Hammer (12) onto Spindle (11).
2. Thread Lock Nut (3) onto threaded end of Spindle (11), hollow side first. It serves as a Hammer Stop for the forward motion of the Slide Hammer (12).
3. Insert Cross Bar (9) into eyelet at the end of the Spindle.

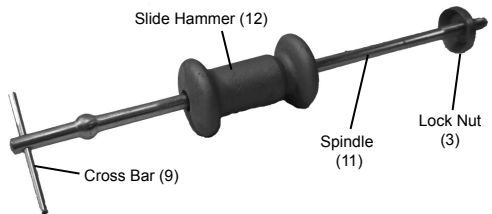

Figure A

Pulling Operation (Hub/Axle/Drum)

1. Raise the vehicle according to its service instructions. Safely support the vehicle on lift or jack stands (not included).
2. Remove the wheel and tire and any nuts, bolts or accessories (such as brake calipers) that may get in the way of removing the Hub/Axle/Drum.
3. Bolt the Rear Axle Puller (2) onto the Hub/Axle/Drum using the original lug nuts. If your vehicle has a four-bolt Hub, match the Rear Axle Puller to two axle bolts. If it has a five-bolt Hub, match to three axle bolts. Tighten the lug nuts.
4. Thread the Spindle into the Rear Axle Puller hub until its non-threaded end exits the hub. Turn the Lock Nut (3) forward until it seats against the Rear Axle Puller hub and hand tighten.

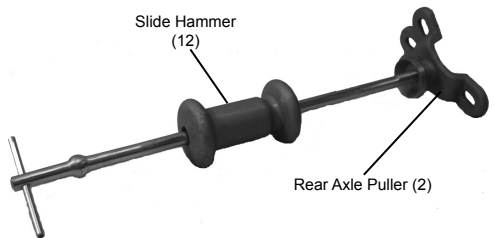

Figure B

5. Push the Slide Hammer towards the work piece, and then forcefully pull it back towards the cross bar end. Repeat and adjust force as needed.

External Grip Jaw Operation

1. Use the Bolts and Nuts to attach the Jaws to the 2 or 3 Jaw Puller Adapters (6/10), as needed. Thread the adapter onto the Spindle until non-threaded end of the Spindle exits the Adapter.

Note: To grip the work piece externally, claws of the Jaws should be facing inward, as shown in Figure C and Figure D.

2. Clamp the Jaws onto the object to be pulled. Turn Lock Nut (3) clockwise against the end of the Jaws, forcing them closed, causing the claws to be pushed inward against the work piece. Tighten the Bolts and Nuts firmly.
3. Push the Slide Hammer towards the work piece, and then forcefully pull it back towards the cross bar end. Repeat and adjust force as needed.

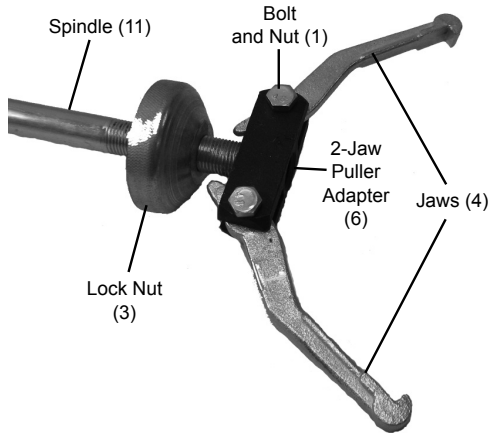

Figure C

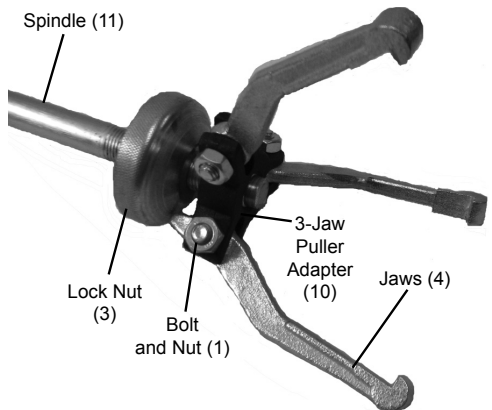

Figure D

Internal Grip Jaw Operation

1. To use Jaws to grip an object from the inside, thread the Lock Nut onto the spindle with the conical side first.
2. Use the Bolts and Nuts to attach the Jaws to the 2 or 3 Jaw Puller Adapters (6/10), as needed. Thread the adapter onto the Spindle until non-threaded end of the Spindle exits the Adapter.
3. Back-off the Lock Nut (3) to permit the jaws to be attached to the workpiece. Turn the Lock Nut forward, causing the claws to expand and grip the work piece firmly. Tighten the fasteners.
4. Push the Slide Hammer towards the work piece, and then forcefully pull it back towards the cross bar end. Repeat and adjust force as needed.

Note: To grip the work piece internally, claws of the Jaws should be facing outward.

Operation (Dent Pulling)

1. Drill a 1/8" hole into the center of the dent.
2. Place the Screw (13) through the Dent Puller Adapter (7). See Figure E.
3. Thread the Screw into the drilled hole using a #2 Phillips screwdriver.
4. Thread the Spindle into the Dent Puller Adapter. Thread the Lock Nut (3) against the Dent Puller Adapter and hand tighten.

5. Push the Slide Hammer towards the work piece, and then forcefully pull it back towards the cross bar end. Repeat and adjust force as needed.

CAUTION! Do not use excessive force when pulling dents. Sheet metal can easily bend or tear.

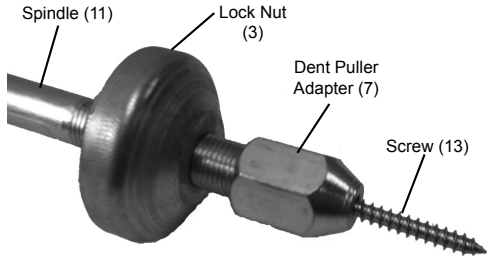

Figure E

Operation (Hook/Thread Pulling)

1. Identify the lip area you will be inserting the Puller Hook (5) into.
2. Thread the Puller Hook onto the end of the Spindle. See Figure F.

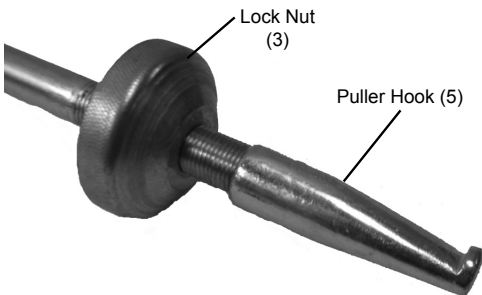

Figure F

3. Place the Puller Hook tip onto the edge of the lip of object to be pulled.
4. Push the Slide Hammer toward the object to be pulled. Gently pull the Slide Hammer toward the Handle Cross Bar.
5. Repeat Step 4 until object has been pulled out.

6. Use the Bolt Adapter (8) for larger cross sections, thicker sheet metal, and concentrated deep dents. See Figure G.

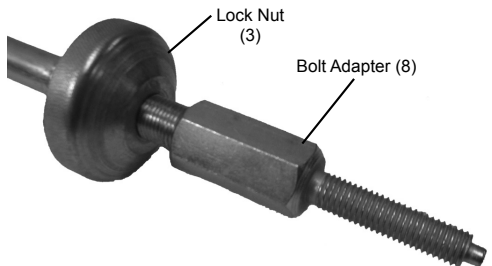

Figure G

7. Follow the Steps 1-5 until threaded object has been pulled out.

Maintenance and Servicing

▲WARNING

TO PREVENT SERIOUS INJURY FROM TOOL FAILURE:

Do not use damaged equipment. If abnormal noise or vibration occurs, have the problem corrected before further use.

Cleaning, Maintenance, and Lubrication

1. **BEFORE EACH USE**, inspect the general condition of the tool. Check for:
 - loose hardware
 - misalignment or binding of moving parts
 - cracked or broken parts
 - any other condition that may affect its safe operation.
2. **AFTER USE**, wipe the tool off with a clean cloth.
3. When storing, keep Slide Hammer and Puller Set in its Carrying Case (14).

PLEASE READ THE FOLLOWING CAREFULLY

THE MANUFACTURER AND/OR DISTRIBUTOR HAS PROVIDED THE PARTS LIST AND ASSEMBLY DIAGRAM IN THIS DOCUMENT AS A REFERENCE TOOL ONLY. NEITHER THE MANUFACTURER OR DISTRIBUTOR MAKES ANY REPRESENTATION OR WARRANTY OF ANY KIND TO THE BUYER THAT HE OR SHE IS QUALIFIED TO MAKE ANY REPAIRS TO THE PRODUCT, OR THAT HE OR SHE IS QUALIFIED TO REPLACE ANY PARTS OF THE PRODUCT. IN FACT, THE MANUFACTURER AND/OR DISTRIBUTOR EXPRESSLY STATES THAT ALL REPAIRS AND PARTS REPLACEMENTS SHOULD BE UNDERTAKEN BY CERTIFIED AND LICENSED TECHNICIANS, AND NOT BY THE BUYER. THE BUYER ASSUMES ALL RISK AND LIABILITY ARISING OUT OF HIS OR HER REPAIRS TO THE ORIGINAL PRODUCT OR REPLACEMENT PARTS THERETO, OR ARISING OUT OF HIS OR HER INSTALLATION OF REPLACEMENT PARTS THERETO.

Parts List and Diagram

Part	Description	Qty.	Part	Description	Qty.
1	Bolt and Nut Set (M8x1.25)	3	8	Bolt Adapter (M12x1.75)	1
2	Rear Axle Puller	1	9	Handle Cross Bar	1
3	Lock Nut	1	10	3-Jaw Puller Adapter	1
4	Jaw	3	11	Spindle	1
5	Puller Hook	1	12	Slide Hammer	1
6	2-Jaw Puller Adapter	1	13	Screw	1
7	Dent Puller Adapter	1	14	Carrying Case (not shown)	1

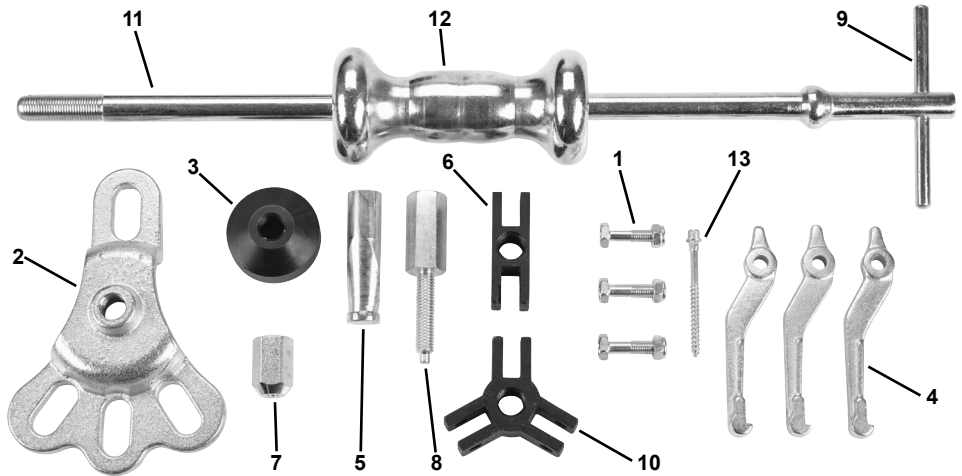

Record Serial Number Here:

Note: If product has no serial number, record month and year of purchase instead.

Note: Some parts are listed and shown for illustration purposes only, and are not available individually as replacement parts.

Limited 90 Day Warranty

Harbor Freight Tools Co. makes every effort to assure that its products meet high quality and durability standards, and warrants to the original purchaser that this product is free from defects in materials and workmanship for the period of 90 days from the date of purchase. This warranty does not apply to damage due directly or indirectly, to misuse, abuse, negligence or accidents, repairs or alterations outside our facilities, criminal activity, improper installation, normal wear and tear, or to lack of maintenance. We shall in no event be liable for death, injuries to persons or property, or for incidental, contingent, special or consequential damages arising from the use of our product. Some states do not allow the exclusion or limitation of incidental or consequential damages, so the above limitation of exclusion may not apply to you. THIS WARRANTY IS EXPRESSLY IN LIEU OF ALL OTHER WARRANTIES, EXPRESS OR IMPLIED, INCLUDING THE WARRANTIES OF MERCHANTABILITY AND FITNESS.

To take advantage of this warranty, the product or part must be returned to us with transportation charges prepaid. Proof of purchase date and an explanation of the complaint must accompany the merchandise. If our inspection verifies the defect, we will either repair or replace the product at our election or we may elect to refund the purchase price if we cannot readily and quickly provide you with a replacement. We will return repaired products at our expense, but if we determine there is no defect, or that the defect resulted from causes not within the scope of our warranty, then you must bear the cost of returning the product.

This warranty gives you specific legal rights and you may also have other rights which vary from state to state.

MADDOX™
SUPERIOR AUTOMOTIVE TOOLS