

Owner's Manual & Safety Instructions

Save This Manual Keep this manual for the safety warnings and precautions, assembly, operating, inspection, maintenance and cleaning procedures. Write the product's serial number in the back of the manual near the assembly diagram (or month and year of purchase if product has no number). Keep this manual and the receipt in a safe and dry place for future reference.

17k

luminar **WORK**TM

MODEL 63973

500 WATT HALOGEN WORKLIGHT KIT



Visit our website at: <http://www.harborfreight.com>
Email our technical support at: productsupport@harborfreight.com

When unpacking, make sure that the product is intact and undamaged. If any parts are missing or broken, please call 1-888-866-5797 as soon as possible.

Copyright© 2017 by Harbor Freight Tools®. All rights reserved.





No portion of this manual or any artwork contained herein may be reproduced in any shape or form without the express written consent of Harbor Freight Tools. Diagrams within this manual may not be drawn proportionally. Due to continuing improvements, actual product may differ slightly from the product described herein.

Tools required for assembly and service may not be included.

⚠ WARNING

**Read this material before using this product.
Failure to do so can result in serious injury.
SAVE THIS MANUAL.**

WARNING SYMBOLS AND DEFINITIONS

	This is the safety alert symbol. It is used to alert you to potential personal injury hazards. Obey all safety messages that follow this symbol to avoid possible injury or death.
 DANGER	Indicates a hazardous situation which, if not avoided, will result in death or serious injury.
 WARNING	Indicates a hazardous situation which, if not avoided, could result in death or serious injury.
 CAUTION	Indicates a hazardous situation which, if not avoided, could result in minor or moderate injury.
NOTICE CAUTION	Addresses practices not related to personal injury.

INSTRUCTIONS PERTAINING TO A RISK OF FIRE, ELECTRIC SHOCK, EXPOSURE TO EXCESSIVE UV RADIATION, OR INJURY TO PERSONS.

IMPORTANT SAFETY INSTRUCTIONS

Lighted Lamp is HOT:

WARNING – To reduce the risk of FIRE, ELECTRIC SHOCK, EXPOSURE TO EXCESSIVE UV RADIATION, OR INJURY TO PERSONS:

1. Turn off/unplug and allow to cool before replacing bulb.
2. Bulb gets HOT quickly!
Only contact On/Off Button/Plug when turning on.
3. Do not touch hot lens, guard, or enclosure.
4. Do not remain in light if skin feels warm.
5. Do not look directly at lighted lamp.
6. Keep lamp away from materials that may burn.
7. Use only with 500 watt or smaller bulbs.
8. Do not touch the bulb at any time. Use a soft cloth instead. Oil from your skin may damage the bulb.
9. Do not operate the portable luminaire with a missing or damaged guard, lamp containment barrier, or UV filter.
10. Avoid electric shock. Do not use with an extension cord near water or where water may accumulate. Keep lamp at least 16 feet (5m) from pools and spas. Keep plugs and receptacles dry. Use only on GFCI-protected circuits. Do not submerge the Light in water.
11. The Light is not waterproof. Use extreme caution in any wet location.
12. Be careful when placing tripod. Make certain that the area is clear of debris and obstructions that may bump the Light.
13. Do not obstruct walkways or common areas with the cord.
14. Maintain labels and nameplates on the Light. These carry important safety information. If unreadable or missing, contact Harbor Freight Tools for a replacement.
15. This product is not intended for use in a residence or to be mounted in a cabinet. This product is not suitable for recessed installation in ceilings or on buildings. This product can cause a fire.
16. Do not leave the Light unattended when it is plugged into an electrical outlet. Turn off the Light, and unplug it from its electrical outlet before leaving.
17. This product is not a toy. Keep it out of reach of children.
18. People with pacemakers should consult their physician(s) before use. Electromagnetic fields in close proximity to heart pacemaker could cause pacemaker interference or pacemaker failure. In addition, people with pacemakers should:
 - Avoid operating alone.

- Properly maintain and inspect to avoid electrical shock.
 - Properly ground power cord. Ground Fault Circuit Interrupter (GFCI) should also be implemented – it prevents sustained electrical shock
- The warnings, precautions, and instructions discussed in this instruction manual cannot cover all possible conditions and situations that may occur. It must be understood by the operator that common sense and caution are factors which cannot be built into this product, but must be supplied by the operator.
 - Do not operate a Light in explosive atmospheres, such as in the presence of flammable liquids, gases, or dust. A Light creates sparks which may ignite the dust or fumes.
 - Do not abuse the cord. Never use the cord for carrying, pulling, or unplugging the Light. Keep the cord away from heat, oil, sharp edges, and moving parts. Damaged or entangled cords increase the risk of electric shock.
 - Stay alert, watch what you are doing, and use common sense when operating a Light. Do not use a Light while you are tired or under the influence of drugs, alcohol, or medication. A moment of inattention while operating a Light may result in serious personal injury.
 - Do not use the Light if the On/Off Button does not turn it on and off. Any Light that cannot be controlled with the Button is dangerous and must be repaired.
 - Have your Light serviced by a qualified repair person. Use only identical replacement parts. This will ensure that the safety of the Light is maintained.
 - Always point the Light away from a wall, whether the unit is in use or not. If the Light is accidentally pointed at a wall while it is on or while it is still hot when turned off, a fire may result.
 - Wear ANSI-approved goggles during assembly.



SAVE THESE INSTRUCTIONS.

Grounding

⚠ WARNING



TO PREVENT ELECTRIC SHOCK AND DEATH FROM INCORRECT GROUNDING WIRE CONNECTION:

Check with a qualified electrician if you are in doubt as to whether the outlet is properly grounded. Do not modify the power cord plug provided with the Light. Never remove the grounding prong from the plug. Do not use the Light if the power cord or plug is damaged. If damaged, have it repaired by a service facility before use. If the plug will not fit the outlet, have a proper outlet installed by a qualified electrician.

Grounded Lights: Lights with Three-Prong Plugs

- Lights marked with "Grounding Required" have a three wire cord and a three prong grounding plug. The plug must be connected to a properly grounded outlet. If the Light should electrically malfunction or break down, grounding provides a low resistance path to carry electricity away from the user, reducing the risk of electric shock. **(See 3-Prong Plug and Outlet.)**
- The grounding prong in the plug is connected through the green wire inside the cord to the grounding system in the Light. The green wire in the cord must be the only wire connected to the Light's grounding system and must never be attached to an electrically "live" terminal. **(See 3-Prong Plug and Outlet.)**
- The Light must be plugged into an appropriate outlet, properly installed and grounded in accordance with all codes and ordinances. The plug and outlet should look like those in the preceding illustration. **(See 3-Prong Plug and Outlet.)**

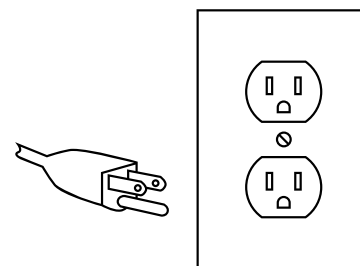

3-Prong Plug and Outlet

Extension Cords



1. **Grounded** Lights require a three-wire extension cord. **Double Insulated** Lights can use either a two or three wire extension cord.
2. As the distance from the supply outlet increases, you must use a heavier gauge extension cord. Using extension cords with inadequately sized wire causes a serious drop in voltage, resulting in loss of power and possible tool damage. (See Table A.)
3. The smaller the gauge number of the wire, the greater the capacity of the cord. For example, a 14 gauge cord can carry a higher current than a 16 gauge cord.
4. When using more than one extension cord to make up the total length, make sure each cord contains at least the minimum wire size required.
5. If you are using one extension cord for more than one tool, add the nameplate amperes and use the sum to determine the required minimum cord size.
6. If you are using an extension cord outdoors, make sure it is marked with the suffix "W-A" ("W" in Canada) to indicate it is acceptable for outdoor use.





7. Make sure the extension cord is properly wired and in good electrical condition. Always replace a damaged extension cord or have it repaired by a qualified electrician before using it.
8. Protect the extension cords from sharp objects, excessive heat, and damp or wet areas.

TABLE A: RECOMMENDED MINIMUM WIRE GAUGE FOR EXTENSION CORDS* (120 VOLT)					
NAMEPLATE AMPERES (at full load)	EXTENSION CORD LENGTH				
	25'	50'	75'	100'	150'
0 – 2.0	18	18	18	18	16
2.1 – 3.4	18	18	18	16	14
3.5 – 5.0	18	18	16	14	12
5.1 – 7.0	18	16	14	12	12
7.1 – 12.0	16	14	12	10	-
12.1 – 16.0	14	12	10	-	-
16.1 – 20.0	12	10	-	-	-

* Based on limiting the line voltage drop to five volts at 150% of the rated amperes.

Symbology

	Double Insulated
	Canadian Standards Association
	Underwriters Laboratories, Inc.
VAC	Volts Alternating Current
A	Amperes
n ₀ xxxx/ min.	No Load Revolutions per Minute (RPM)

	WARNING marking concerning Risk of Eye Injury. Wear ANSI-approved safety goggles with side shields.
	Read the manual before set-up and/or use.
	WARNING marking concerning Risk of Fire. Do not cover ventilation ducts. Keep flammable objects away.
	WARNING marking concerning Risk of Electric Shock. Properly connect power cord to appropriate outlet.

Specifications

Electrical Rating	120VAC / 60Hz / 3.9A
Bulb	500W /120VAC Halogen (included)

Set Up Instructions



Read the **ENTIRE IMPORTANT SAFETY INSTRUCTIONS** section at the beginning of this manual, including all text under subheadings therein before setup or use of this product.

WARNING

Risk of accidental starting, resulting in serious personal injury. Turn the Power Switch of the Light OFF and unplug it from the electrical outlet before assembling or making any adjustments.

Deviation from the assembly instructions may result in a risk of fire or electric shock.

Note: For additional information regarding the parts listed in the following pages, refer to the Assembly Diagram near the end of this manual.

Setup

1. Place Screw (47) through holes in H Stand (7) and set Bracket (5) on top of H Stand.
2. Secure H Stand to Bracket with Washer (45) and Nut (46).
3. Remove the Screw (39) at the top of the housing and open the Lamp Cover (2).
4. Insert the Bulb (22) into the Bulb Socket (21).

NOTICE: Do not touch the Bulb with your bare hands; oil from skin will drastically shorten the life span of the bulb if not cleaned with rubbing alcohol and allowed to dry before use. Handle the bulb with a soft, clean cloth or clean work gloves instead.

5. Close the Lamp Cover (2) and secure to Shell (1) with the Screw (39).
6. Gently squeeze the Wire Cover (6) while placing its four tabs into the Lamp Cover (2).

Secure the tab on the Wire Cover to the Lamp Cover using the Bolt (28). (See Figure A.)

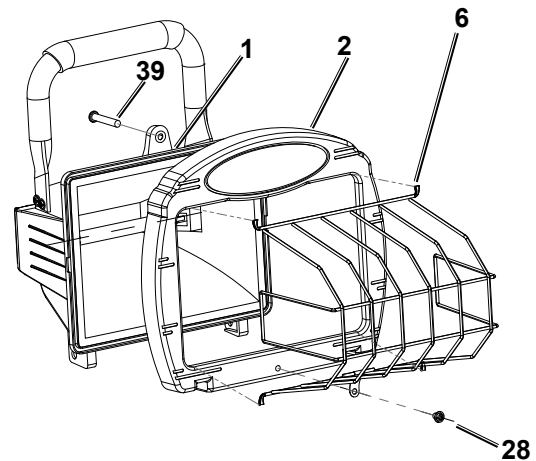

Figure A

Operating Instructions



Read the **ENTIRE IMPORTANT SAFETY INSTRUCTIONS** section at the beginning of this manual, including all text under subheadings therein before setup or use of this product.

1. Plug the Light into a standard 120V grounded, electric outlet.
2. Push the On/Off switch on the back of the Light.
3. **WARNING! Keep the Light away from combustible objects. The light and housing will get hot enough to start a fire.**
4. To turn off, push the On/Off switch.
5. To prevent accidents; turn off Light and disconnect power supply after use. Allow the Light to cool. Clean, then store the Light indoors out of children's reach.

Maintenance and Servicing



Procedures not specifically explained in this manual must be performed only by a qualified technician.

⚠️WARNING

TO PREVENT SERIOUS INJURY FROM ACCIDENTAL OPERATION:

Make sure that the On/Off Button is in the OFF position and unplug the tool from its electrical outlet before performing any procedure in this section.

TO PREVENT SERIOUS INJURY FROM LIGHT FAILURE:

Do not use damaged equipment. If damage is noted, have the problem corrected before further use.

- BEFORE EACH USE**, inspect the general condition of the light. Check for:
 - loose hardware,
 - damaged cord/electrical wiring,
 - cracked or broken parts, and
 - any other condition that may affect its safe operation.
- AFTER USE**, allow Light to cool and then wipe external surfaces of the Light with a clean cloth.

⚠️WARNING! If the supply cord of this light is damaged, it must be replaced only by a qualified service technician.

Note: Replacement parts may not be available for this item.

PLEASE READ THE FOLLOWING CAREFULLY

THE MANUFACTURER AND/OR DISTRIBUTOR HAS PROVIDED THE PARTS LIST AND ASSEMBLY DIAGRAM IN THIS MANUAL AS A REFERENCE TOOL ONLY. NEITHER THE MANUFACTURER OR DISTRIBUTOR MAKES ANY REPRESENTATION OR WARRANTY OF ANY KIND TO THE BUYER THAT HE OR SHE IS QUALIFIED TO MAKE ANY REPAIRS TO THE PRODUCT, OR THAT HE OR SHE IS QUALIFIED TO REPLACE ANY PARTS OF THE PRODUCT. IN FACT, THE MANUFACTURER AND/OR DISTRIBUTOR EXPRESSLY STATES THAT ALL REPAIRS AND PARTS REPLACEMENTS SHOULD BE UNDERTAKEN BY CERTIFIED AND LICENSED TECHNICIANS, AND NOT BY THE BUYER. THE BUYER ASSUMES ALL RISK AND LIABILITY ARISING OUT OF HIS OR HER REPAIRS TO THE ORIGINAL PRODUCT OR REPLACEMENT PARTS THERETO, OR ARISING OUT OF HIS OR HER INSTALLATION OF REPLACEMENT PARTS THERETO.

Parts List and Diagram

Part	Description	Qty	Part	Description	Qty
1	Shell	1	26	Jump Ring	2
2	Lamp Cover	1	27	Washer	2
3	Ellipse Logo Plate	1	28	Bolt M4*5	2
4	Reflector	1	29	Bolt M4*5	1
5	Bracket	1	30	Bolt M4*6	1
6	Wire Cover	1	31	Bolt M4*5	2
7	H Stand	1	32	Bolt M4*6	2
8	Lamp Handle	1	33	Φ4 Spring Washer	1
9	Junction Box Base	1	34	Φ4 Washer	4
10	Junction Box Cover	1	35	Screw M4*14	1
11	Switch Nut	1	36	BT M4*14	2
12	Φ7.5 Ring	1	37	BT M4*14	4
13	Wire Press Board	1	38	Φ4 Washer	1
14	Junction Box Hex Sleeve	1	39	Screw M4*8	1
15	Seal Ring	1	40	Screw M5*17	1
16	O-Ring	1	41	Φ6 Washer	2
17	3-prong	1	42	Screw M6*14	1
18	15*30 Square Plug	2	43	Screw M6*14	1
19	Φ22*28 feet cover	4	44	Nut M6	2
20	Hand Guard	1	45	Screw 4*8	4
21	Bulb Socket	1	46	Φ6 Washer	2
22	Bulb	1	47	Nut M6	2
23	Switch	1	48	Screw M6*25	2
24	Wire Nut	3	49	Glass	2
25	Power Cord	1			

Assembly Diagram

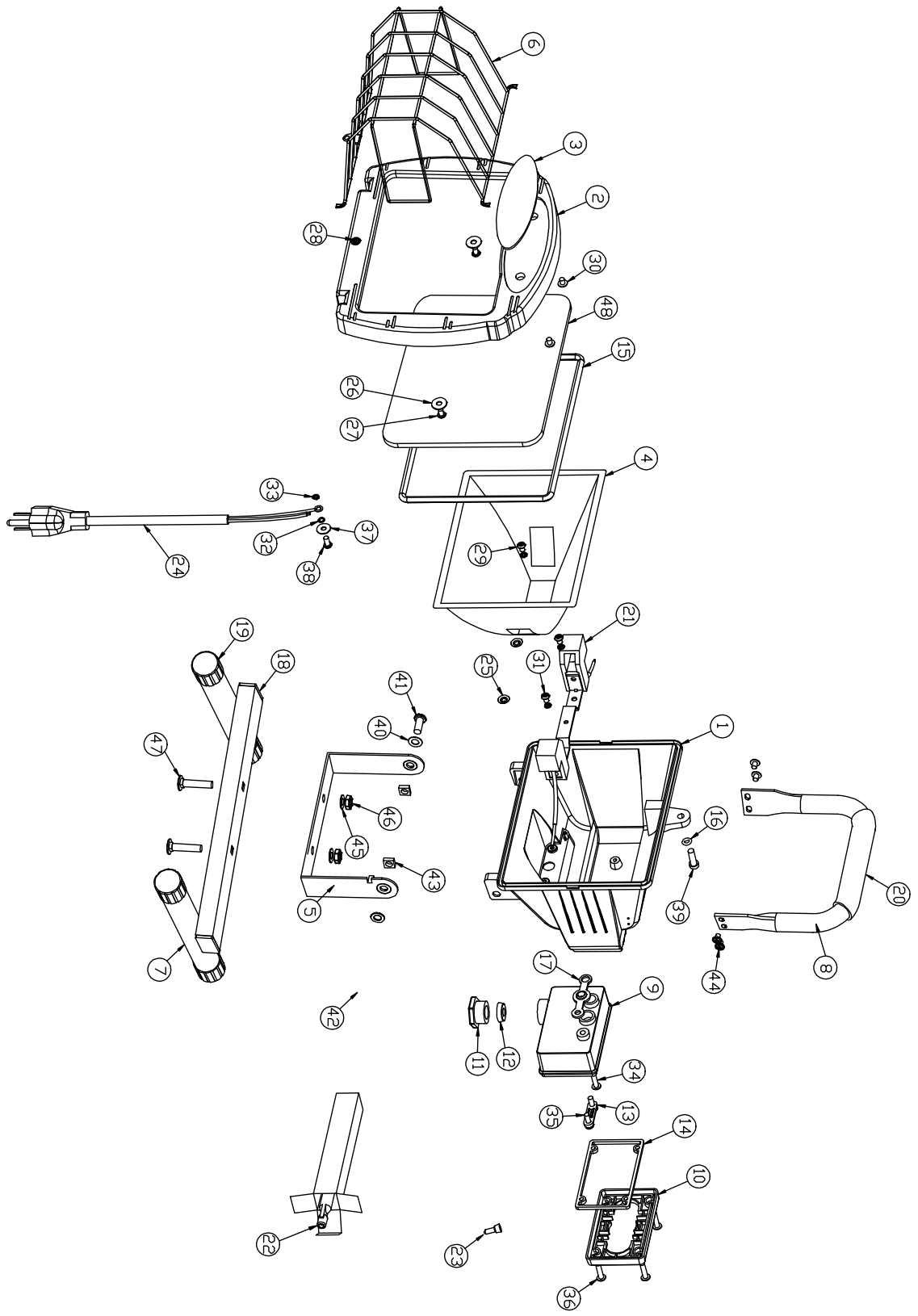

Record Serial Number Here: _____

Note: If light has no serial number, record month and year of purchase instead.

Note: Some parts are listed and shown for illustration purposes only, and are not available individually as replacement parts.

Limited 90 Day Warranty

Harbor Freight Tools Co. makes every effort to assure that its products meet high quality and durability standards, and warrants to the original purchaser that this product is free from defects in materials and workmanship for the period of 90 days from the date of purchase. This warranty does not apply to damage due directly or indirectly, to misuse, abuse, negligence or accidents, repairs or alterations outside our facilities, criminal activity, improper installation, normal wear and tear, or to lack of maintenance. We shall in no event be liable for death, injuries to persons or property, or for incidental, contingent, special or consequential damages arising from the use of our product. Some states do not allow the exclusion or limitation of incidental or consequential damages, so the above limitation of exclusion may not apply to you. THIS WARRANTY IS EXPRESSLY IN LIEU OF ALL OTHER WARRANTIES, EXPRESS OR IMPLIED, INCLUDING THE WARRANTIES OF MERCHANTABILITY AND FITNESS.

To take advantage of this warranty, the product or part must be returned to us with transportation charges prepaid. Proof of purchase date and an explanation of the complaint must accompany the merchandise. If our inspection verifies the defect, we will either repair or replace the product at our election or we may elect to refund the purchase price if we cannot readily and quickly provide you with a replacement. We will return repaired products at our expense, but if we determine there is no defect, or that the defect resulted from causes not within the scope of our warranty, then you must bear the cost of returning the product.

This warranty gives you specific legal rights and you may also have other rights which vary from state to state.



3491 Mission Oaks Blvd. • PO Box 6009 • Camarillo, CA 93011 • 1-888-866-5797