

Owner's Manual & Safety Instructions

Save This Manual Keep this manual for the safety warnings and precautions, assembly, operating, inspection, maintenance and cleaning procedures. Write the product's serial number in the back of the manual near the assembly diagram (or month and year of purchase if product has no number). Keep this manual and the receipt in a safe and dry place for future reference.

18j

U.S. GENERAL

26" x 22" Single Bank Roller Cabinet



64162

Visit our website at: <http://www.harborfreight.com>
Email our technical support at: productsupport@harborfreight.com

When unpacking, make sure that the product is intact and undamaged. If any parts are missing or broken, please call 1-888-866-5797 as soon as possible.

Copyright© 2017 by Harbor Freight Tools®. All rights reserved.
No portion of this manual or any artwork contained herein may be reproduced in any shape or form without the express written consent of Harbor Freight Tools. Diagrams within this manual may not be drawn proportionally. Due to continuing improvements, actual product may differ slightly from the product described herein. Tools required for assembly and service may not be included.

⚠ WARNING

Read this material before using this product. Failure to do so can result in serious injury. **SAVE THIS MANUAL.**

Specifications

Total Combined Weight Capacity (Evenly distributed from bottom up.)	1000 lb
--	---------

U.S. GENERAL

IMPORTANT SAFETY INFORMATION

Assembly Precautions

1. Assemble only according to these instructions. Improper assembly can create hazards.
2. Wear ANSI-approved safety goggles and heavy-duty work gloves during assembly.
3. Keep assembly area clean and well lit.
4. Keep bystanders out of the area during assembly.
5. Do not assemble when tired or when under the influence of alcohol, drugs or medication.
6. Weight capacity and other product capabilities apply to properly and completely assembled product only.
7. Assemble on a flat, level, hard and smooth surface capable of safely supporting a fully loaded Cabinet.

Use Precautions

TO PREVENT SERIOUS INJURY AND DEATH FROM TIPPING:

1. **DO NOT SIT, STAND OR CLIMB ON THIS ITEM.**
2. This product is not a toy nor a toy chest. Do not allow children to play with or near this item.
3. Do not exceed weight capacities, evenly distributed from bottom up.
Be aware of dynamic loading!
Sudden load movement may briefly create excess load causing product failure.
4. Do not open more than one Drawer at once.
5. Empty, close, and lock Drawers before moving.
6. Use only on a flat, level, hard and smooth surface capable of safely supporting a fully loaded Cabinet. Do not roll Cabinet over concrete seams or other rough/uneven surfaces.
7. Do not lift using handle(s). Do not move or lift while loaded.
8. Lock Swivel Casters after moving.
9. Do not mount on truck bed or any other moving object.
10. Use as intended only.
11. Inspect before every use; do not use if parts are loose or damaged.
12. Maintain product labels and nameplates. These carry important safety information. If unreadable or missing, contact Harbor Freight Tools for a replacement.

U.S. GENERAL

Assembly Instructions



Read the **ENTIRE IMPORTANT SAFETY INFORMATION** section at the beginning of this document including all text under subheadings therein before set up or use of this product.

1. Assemble on a flat, level, hard and smooth surface capable of safely supporting a fully loaded Cabinet.
2. Locate the Keys, label them, then put them in a safe place.

Note: The Bottom Cabinet and Top Chest have different sets of keys.

3. Attach Side Handle (2) to either side of Cabinet using two Handle Screws (3).

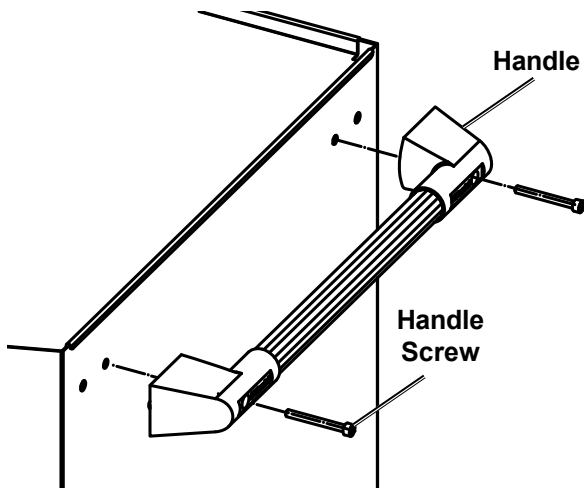

4. Attach two Locking Swivel Casters (9) to the same side as Handle using eight Caster Screw Sets (10).

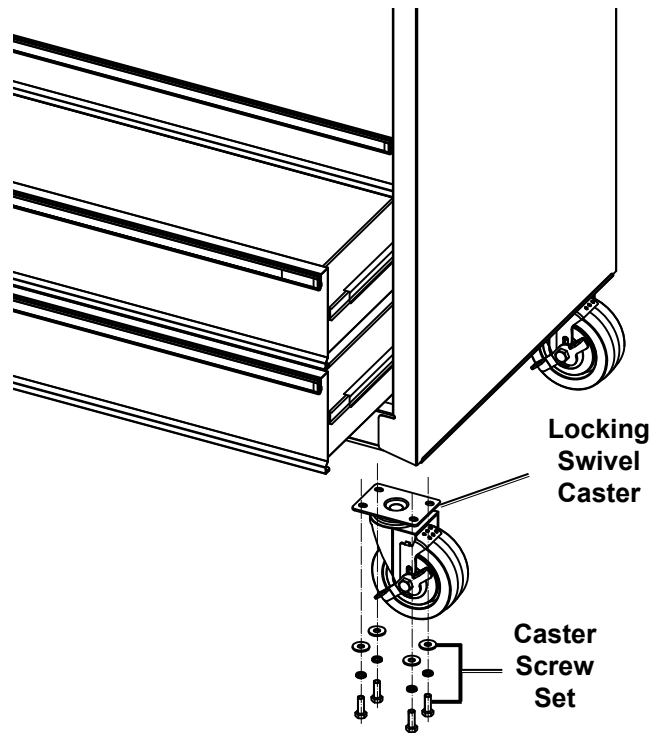

5. Attach two Fixed Casters (8) to the other side using eight Caster Screw Sets (10).
6. Lock the Casters by depressing the brake levers.

Operation Instructions



Read the **ENTIRE IMPORTANT SAFETY INFORMATION** section at the beginning of this document including all text under subheadings therein before set up or use of this product.

1. Empty all Drawers.
2. Close all Drawers and lock them.
3. Unlock Swivel Casters.
4. Roll Cabinet to a flat, level, hard and smooth surface capable of safely supporting a fully loaded Cabinet. Do not roll Cabinet over concrete seams or other rough/uneven surfaces.
5. Lock Swivel Casters.
6. Unlock Drawers and fill Cabinet evenly, from bottom to top. Do not exceed weight capacities.

Maintenance and Servicing



Procedures not specifically explained in this document must be performed only by a qualified technician.

⚠️ WARNING

TO PREVENT SERIOUS INJURY FROM TOOL FAILURE:

Do not use damaged equipment. If any part becomes damaged, have the problem corrected before further use.

1. **PERIODICALLY**, inspect the general condition of the Cabinet. Check for:
 - loose hardware,
 - misalignment or binding of moving parts,
 - brake operation,
 - caster swivel function and movement,
 - cracked or broken parts,
 - any other condition that may affect its safe operation.
2. Wipe external surfaces of the Cabinet with clean cloth.
3. Lubricate Drawer Slides as needed.

U.S. GENERAL

PLEASE READ THE FOLLOWING CAREFULLY

THE MANUFACTURER AND/OR DISTRIBUTOR HAS PROVIDED THE PARTS LIST AND ASSEMBLY DIAGRAM IN THIS DOCUMENT AS A REFERENCE TOOL ONLY. NEITHER THE MANUFACTURER OR DISTRIBUTOR MAKES ANY REPRESENTATION OR WARRANTY OF ANY KIND TO THE BUYER THAT HE OR SHE IS QUALIFIED TO MAKE ANY REPAIRS TO THE PRODUCT, OR THAT HE OR SHE IS QUALIFIED TO REPLACE ANY PARTS OF THE PRODUCT. IN FACT, THE MANUFACTURER AND/OR DISTRIBUTOR EXPRESSLY STATES THAT ALL REPAIRS AND PARTS REPLACEMENTS SHOULD BE UNDERTAKEN BY CERTIFIED AND LICENSED TECHNICIANS, AND NOT BY THE BUYER. THE BUYER ASSUMES ALL RISK AND LIABILITY ARISING OUT OF HIS OR HER REPAIRS TO THE ORIGINAL PRODUCT OR REPLACEMENT PARTS THERETO, OR ARISING OUT OF HIS OR HER INSTALLATION OF REPLACEMENT PARTS THERETO.

Parts List and Diagram

Parts List

Part	Description	Qty
1	Top Shelf Liner	1
2	Side Handle	1
3	Handle Screw (M6x55)	2
4	Drawer Label and Cover	8
5	Drawer Trim	8
6	Drawer Slide	16
7	Drawer Liner	8
8	Fixed Caster	2
9	Locking Swivel Caster	2
10	Caster Screw Set (M8x25)	16

Part	Description	Qty
11	Lock	1
12	Key (not shown)	3
13	Cotter Pin	1
14	Lock Bar	1
15	End Cap	16
A	Drawer	3
B	Drawer	2
C	Drawer	1
D	Drawer	2

Record Serial Number Here: _____

Note: If product has no serial number, record month and year of purchase instead.

Note: Some parts are listed and shown for illustration purposes only, and are not available individually as replacement parts.

Assembly Diagram

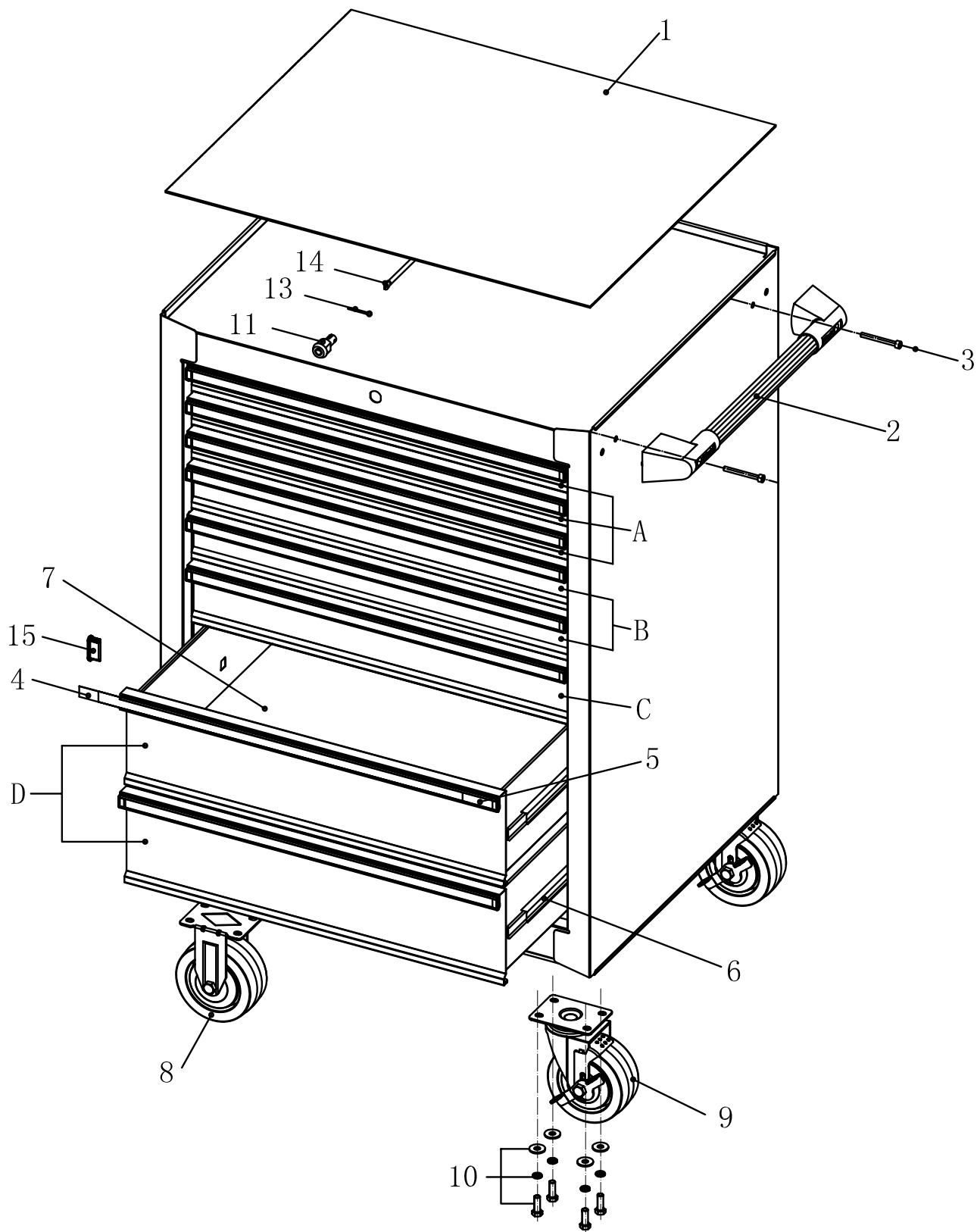

Limited 90 Day Warranty

Harbor Freight Tools Co. makes every effort to assure that its products meet high quality and durability standards, and warrants to the original purchaser that this product is free from defects in materials and workmanship for the period of 90 days from the date of purchase. This warranty does not apply to damage due directly or indirectly, to misuse, abuse, negligence or accidents, repairs or alterations outside our facilities, criminal activity, improper installation, normal wear and tear, or to lack of maintenance. We shall in no event be liable for death, injuries to persons or property, or for incidental, contingent, special or consequential damages arising from the use of our product. Some states do not allow the exclusion or limitation of incidental or consequential damages, so the above limitation of exclusion may not apply to you. THIS WARRANTY IS EXPRESSLY IN LIEU OF ALL OTHER WARRANTIES, EXPRESS OR IMPLIED, INCLUDING THE WARRANTIES OF MERCHANTABILITY AND FITNESS.

To take advantage of this warranty, the product or part must be returned to us with transportation charges prepaid. Proof of purchase date and an explanation of the complaint must accompany the merchandise. If our inspection verifies the defect, we will either repair or replace the product at our election or we may elect to refund the purchase price if we cannot readily and quickly provide you with a replacement. We will return repaired products at our expense, but if we determine there is no defect, or that the defect resulted from causes not within the scope of our warranty, then you must bear the cost of returning the product.

This warranty gives you specific legal rights and you may also have other rights which vary from state to state.

U.S. GENERAL

3491 Mission Oaks Blvd. • PO Box 6009 • Camarillo, CA 93011 • 1-888-866-5797