

Owner's Manual & Safety Instructions

Save This Manual Keep this manual for the safety warnings and precautions, assembly, operating, inspection, maintenance and cleaning procedures. Write the product's serial number in the back of the manual near the assembly diagram (or month and year of purchase if product has no number). Keep this manual and the receipt in a safe and dry place for future reference.

18k



LED-SOLAR Motion Security Light



Visit our website at: <http://www.harborfreight.com>
Email our technical support at: productsupport@harborfreight.com

64734

When unpacking, make sure that the product is intact and undamaged. If any parts are missing or broken, please call 1-888-866-5797 as soon as possible.

Copyright © 2018 by Harbor Freight Tools®. All rights reserved.
No portion of this manual or any artwork contained herein may be reproduced in any shape or form without the express written consent of Harbor Freight Tools. Diagrams within this manual may not be drawn proportionally. Due to continuing improvements, actual product may differ slightly from the product described herein. Tools required for assembly and service may not be included.

⚠ WARNING

Read this material before using this product. Failure to do so can result in serious injury. **SAVE THIS MANUAL.**

Table of Contents

Safety	2	Maintenance	9
Specifications	4	Parts List and Diagram	11
Setup	4	Warranty	12
Operation.....	6		



WARNING SYMBOLS AND DEFINITIONS

	This is the safety alert symbol. It is used to alert you to potential personal injury hazards. Obey all safety messages that follow this symbol to avoid possible injury or death.
	Indicates a hazardous situation which, if not avoided, will result in death or serious injury.
	Indicates a hazardous situation which, if not avoided, could result in death or serious injury.
	Indicates a hazardous situation which, if not avoided, could result in minor or moderate injury.
	Addresses practices not related to personal injury.

IMPORTANT SAFETY INFORMATION

WARNING

Read all safety warnings and instructions.

Failure to follow the warnings and instructions may result in electric shock, fire and/or serious injury.

Save all warnings and instructions for future reference.

- Keep installation area clean.**
Cluttered areas invite accidents.
- Observe installation area conditions.** Keep work area well lit during installation.
- Check for damaged parts.** Before using any product, any part that appears damaged should be carefully checked to determine that it will operate properly and perform its intended function. Check for any broken or damaged parts and any other conditions that may affect its operation. Replace or repair damaged or worn parts immediately. Do not use the Security Light if any switch does not turn on and off properly.
- Replacement parts and accessories.** When servicing, use only identical replacement parts. Use of any other parts will void the warranty.
- Check hardware and assembled parts after assembling.** All connections should be tight and hardware tightened.
- Keep children away.** Mount the Light, Solar Panel, and Cord out of children's reach.
- Dress properly.** Protective, electrically non-conductive clothes and nonskid footwear are recommended when working with the Solar Powered Security Light. Wear restrictive hair covering to contain long hair.
- Use eye protection.** Wear ANSI-approved impact safety goggles when setting up this product.

9. **Maintain products with care.** Keep the Solar Powered Security Light clean for better and safer performance. Inspect the Light periodically. If damaged, have it repaired by a qualified technician.
10. **Do not overreach.** Keep proper footing and balance at all times. If a ladder is to be used during installation, it should be supported by an assistant.
11. **Do not set up the Solar Powered Security Light if under the influence of alcohol or drugs.** Read warning labels on prescriptions to determine if your judgement or reflexes are impaired while taking drugs. If there is any doubt, do not set up the Light.
12. **Have your power tool serviced by a qualified repair person using only identical replacement parts.** *This will ensure that the safety of the power tool is maintained.*
13. The warnings, precautions, and instructions discussed in this instruction manual cannot cover all possible conditions and situations that may occur. It must be understood by the operator that common sense and caution are factors which cannot be built into this product, but must be supplied by the operator.
14. Contains Li-Ion battery. Battery must be recycled or disposed of properly. Do not open, crush, heat above 140°F or incinerate.



SAVE THESE INSTRUCTIONS.

Specifications

Lamp	100 SMD LEDs
Battery Pack	3.7V Li-Ion Battery, 2500 mAh

Setup - Before Use:



Read the **ENTIRE IMPORTANT SAFETY INFORMATION** section at the beginning of this manual including all text under subheadings therein before set up or use of this product.

Note: For additional information regarding the parts listed in the following pages, refer to *Parts List and Diagram* on page 11.

Installation

1. Decide where to place the Lamp and Solar Panel.
 - a. The Solar Panel is equipped with a 15 foot long Solar Power Cable, so the Lamp and Solar Panel can be installed up to 15 feet apart.
 - b. The Solar Panel must be set in a location that receives full, direct sunlight, a minimum of 8 hours a day. Ideally, the Solar Panel should be angled slightly toward the South (northern hemisphere).

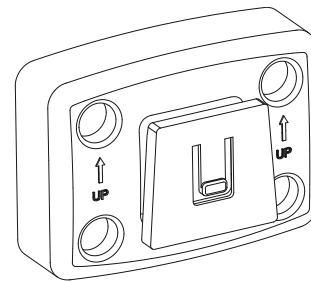

Mounting Plate

2. Mount the **Solar Panel:**
 - a. Place the Solar Panel in the desired location, adjusting the unit to best fit the surface.

WARNING! TO AVOID INJURY FROM ELECTRIC SHOCK, verify the installation surface has no hidden utility lines before drilling or driving screws.

- b. Using the Solar Panel's base as a template, mark the hole locations to install the panel. Set the Solar Panel aside.
- c. Drill holes for the enclosed mounting Anchors.
- d. Insert the Anchors into the holes and attach Solar Panel in place with the Screws.

3. Mount the **Lamp:**
 - a. Locate the unit 6 to 8 feet above ground on a solid surface capable of supporting the Lamp and secure enough so that it will not move when exposed to vibrations or wind. The unit must be high enough to allow for motion detection and light distribution.

WARNING! TO AVOID INJURY FROM ELECTRIC SHOCK, verify the installation surface has no hidden utility lines before drilling or driving screws.

- b. Using the Mounting Plate as a template, mark the hole locations to install the Lamp.
- c. Mount plate against a wall with ridge pointing up and out. Lamp will slide onto ridge.

- d. Drill holes for the enclosed Anchors.
- e. Insert the Anchors into the holes and attach Mounting Plate in place with the Screws.
- f. Slide Lamp onto the Mounting Plate and position lights as needed. Each light moves independently.

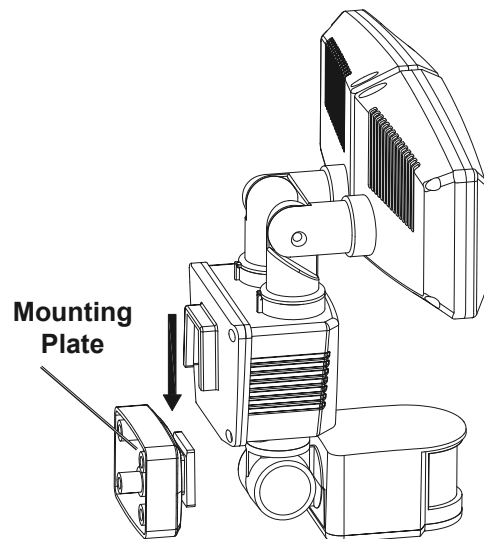

4. Carefully route the Power Cable from the Solar Panel to the Lamp and plug it into the Solar Power Input on the Lamp's Battery Housing.
5. Adjust the Motion Detector Head by moving it left or right so that it faces the area where movement will occur. Move it up or down using the screw located on the neck of the Motion Detector Head.

Functions

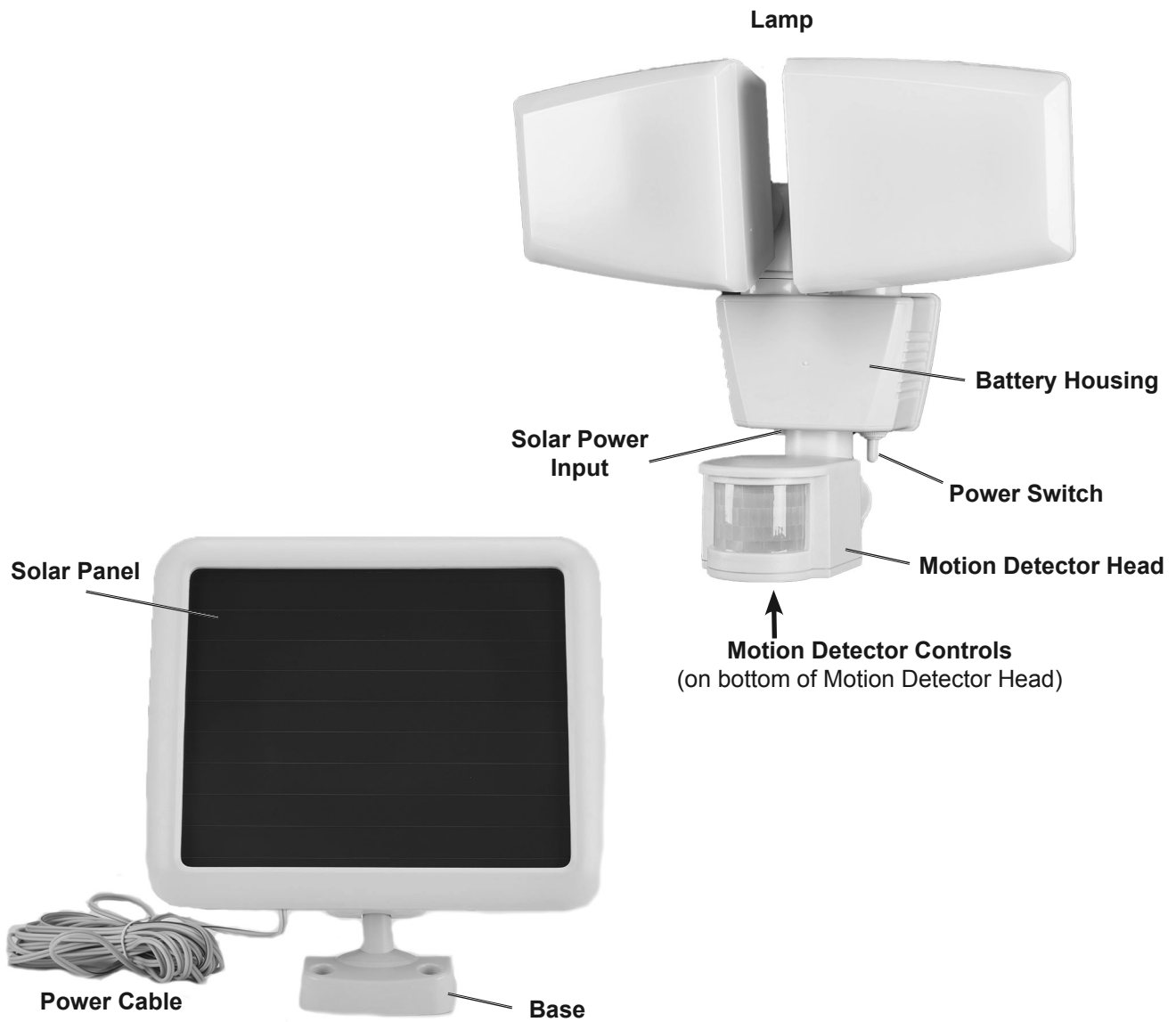

SAFETY

SETUP

OPERATION

MAINTENANCE



Operating Instructions



Read the **ENTIRE IMPORTANT SAFETY INFORMATION** section at the beginning of this manual including all text under subheadings therein before set up or use of this product.

Initial Battery Charging

Before the Security Light can operate properly, the battery needs to be fully charged. To charge the battery:

1. Turn OFF the Power Switch.
2. **Expose the Solar Panel to 3 DAYS OF FULL DIRECT SUNLIGHT** to fully charge the battery.
3. After charging, turn the Power Switch to Auto. The Lamp will illuminate for a short time when first switched to Auto. This indicates that the unit is working properly.

CAUTION

**The UNIT WILL NOT FUNCTION
UNLESS:
The Solar Panel is first charged for
3 DAYS OF FULL SUN
with the SENSOR POWER OFF.**

Power Switch

The Power Switch, located under the Battery Housing of the Lamp, has three settings:

AUTO: The Lamp will illuminate automatically when motion is detected by the Motion Sensor Head.

OFF: Center position is power off.

ON: The Lamp stay illuminated functioning as a normal light.

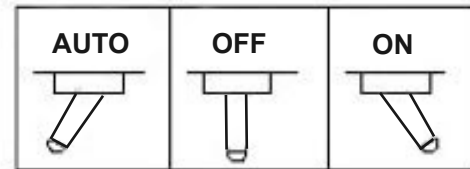

Motion Detector Control Knobs

The Security Light has three different Control Knobs on the underside of the Motion Detector Head. They control the Motion Detector Head's sensor. They are:

- a. Sensor's sensitivity to motion (SENS)
- b. Light duration (TIME)
- c. Sensitivity to light level (LUX)

NOTE: After each adjustment, walk the detection area to verify the adjustment made.

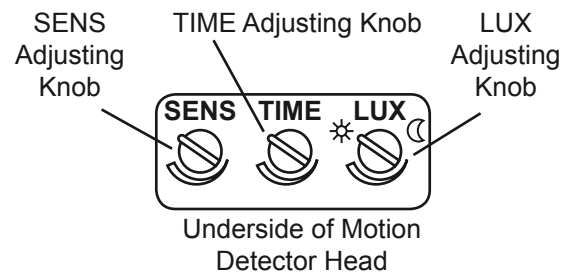

SENS (Sensitivity)

The SENS Adjusting Knob sets the level of sensitivity of the Motion Detector Head.

The Motion Detector Head is most sensitive to movement across the detection zone, rather than movement toward or away from the Motion Detector Head.

Turn the SENS dial anywhere between the minimum and maximum settings to adjust the level of sensitivity needed.

Note: Sensitivity is affected by the ambient air temperature. If it is hot outside, the sensor may have difficulty detecting changes in heat. In cold temperatures, the sensitivity is increased and may need to be adjusted.

Minimum Position

Turn the dial counterclockwise to the minimum setting (-). Ideal for hot summer conditions or when nuisance tripping is a problem. If the light is activated by small animals or rapid changes in heat, reduce sensitivity by turning the knob counterclockwise towards the minimum setting.

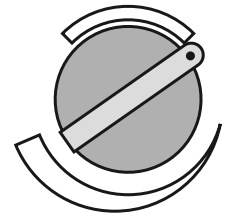

Maximum Position

Turn the dial clockwise to the maximum setting (+). Ideal for cold winter conditions or to maximize range.

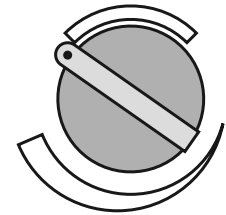

TIME (Light Duration)

The TIME Adjusting Knob sets how long the Lamp will stay illuminated after motion is no longer detected by the sensor.

Minimum Position

Turn the dial counterclockwise to the minimum for the Lamp stay illuminated for 10 seconds after motion is no longer detected.

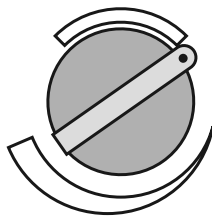

Mid Range

Adjust the dial between the Minimum and Maximum, to choose any time between 10 and 100 seconds, for the Lamp to stay illuminated after motion is no longer detected.

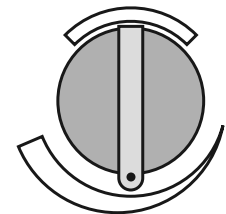

Maximum Position

Turn the dial clockwise to the maximum for the Lamp to stay illuminated for 110 seconds after motion is no longer detected.

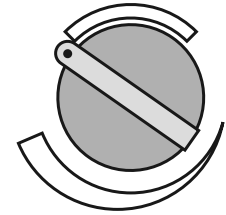

LUX (Light Level)

The LUX Adjusting Knob tells the sensor the level of darkness that must be reached before the Lamp illuminates.

Minimum Position

Turning the dial counterclockwise to the minimum setting lowers the sensor level. The sensor will only trigger the Lamp to illuminate at dusk or when it is dark out. This is the ideal position for general evening and night operation.

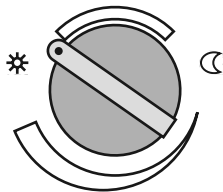

Maximum Position

Turning the dial clockwise to the maximum setting increases the sensor level. The Lamp will illuminate in most situations ranging from dark to daylight.

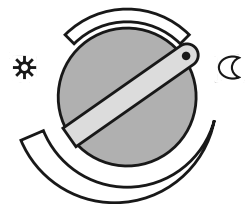

Note: If the Security Light is not operating at night due to interference from a street light or other interference, turn the LUX knob towards the maximum setting ☼. Adjust the dial as needed between the minimum and maximum settings to achieve the desired level of sensitivity.

Testing the Light

After the battery is charged and the control Knobs are set, walk slowly around the detection area. The sensor detects infrared radiation given off by a person or animal. This triggers the Lamp to illuminate. The light should go on in the area that you set up the Security Light to monitor.

Adjust the Knobs and sensor, then re-test until the unit functions as desired.

Repeat the test procedure as needed when weather and/or temperature changes.

SAFETY

SETUP

OPERATION

MAINTENANCE

Maintenance and Servicing



Procedures not specifically explained in this manual must be performed only by a qualified technician.

!WARNING

TO PREVENT SERIOUS INJURY FROM TOOL FAILURE:

Do not use damaged equipment. If abnormal noise or vibration occurs, have the problem corrected before further use.

Cleaning, Maintenance, and Lubrication

1. **BEFORE EACH USE**, inspect the general condition of the unit. Check for:
 - leaking, swollen, or cracked battery,
 - loose hardware,
 - misalignment or binding of parts,
 - cracked or broken parts, and
 - any other condition that may affect its safe operation.
2. **AFTER USE**, wipe external surfaces of the unit with clean cloth.
3. Keep Solar Panel free of dirt and debris to maintain optimum efficiency in recharging the battery.

Battery Removal and Disposal

1. The battery is located inside the Lamp assembly.
2. Turn the Lamp off and remove the screws on the back.
3. Disconnect the battery and remove it from the Lamp.
4. Contains Li-Ion battery. Battery must be recycled or disposed of properly. Do not open, crush, heat above 140°F or incinerate.

Troubleshooting

Problem	Possible Causes	Likely Solutions
Light won't turn on.	<ol style="list-style-type: none"> 1. Power is not on. 2. Solar Power Cable connection is loose. 3. LUX control is set too close to ☒. 4. Motion sensor not detecting movement. 5. Battery pack not fully charged. 	<ol style="list-style-type: none"> 1. Check that Power Switch is set to ON or AUTO. 2. Plug in firmly at back of Battery Housing. 3. Turn LUX knob towards ☒. 4. Adjust angle and direction of Motion Detector Head, and increase sensitivity (SENS). 5. Keep Solar Panel clean and allow unit to charge in full direct sunlight for 3 days with the Power Switch OFF.
Light turns on during day.	LUX control is set too close to ☒.	Turn LUX knob towards ☒.
Light flashes on and off with clicking sounds.	Low battery.	With Power Switch set to OFF, allow unit to charge in full direct sunlight for 3 days before further use.
Light stays "ON".	<ol style="list-style-type: none"> 1. Duration time setting too long. 2. Frequent changes in heat being detected. 3. Power Switch set to ON. 	<ol style="list-style-type: none"> 1. Turn TIME knob counterclockwise to reduce the time the light stays on. 2. Check sensing area for possible heat sources such as air vents, vehicles or objects in wind. Reposition the Motion Detector Head if needed, and turn SENS Knob counterclockwise to lower sensitivity. 3. Set Power Switch to AUTO.
Light turns ON and OFF.	<ol style="list-style-type: none"> 1. Changes in heat are being detected from a fixed heat source or moving object. 2. Sudden temperature change due to storms or high winds. 	<ol style="list-style-type: none"> 1. Check sensing area for possible heat sources such as air vents, vehicles or objects in wind. Reposition the Motion Detector Head. 2. Turn Power Switch "OFF" until storm passes. Mount in a sheltered location.
 <p>Follow all safety precautions whenever diagnosing or servicing the tool. Disconnect Battery and Charger power supply before service.</p>		

Record Product's Serial Number Here: _____

Note: If product has no serial number, record month and year of purchase instead.

Note: Some parts are listed and shown for illustration purposes only, and are not available individually as replacement parts.

PLEASE READ THE FOLLOWING CAREFULLY

THE MANUFACTURER AND/OR DISTRIBUTOR HAS PROVIDED THE PARTS LIST AND ASSEMBLY DIAGRAM IN THIS MANUAL AS A REFERENCE TOOL ONLY. NEITHER THE MANUFACTURER OR DISTRIBUTOR MAKES ANY REPRESENTATION OR WARRANTY OF ANY KIND TO THE BUYER THAT HE OR SHE IS QUALIFIED TO MAKE ANY REPAIRS TO THE PRODUCT, OR THAT HE OR SHE IS QUALIFIED TO REPLACE ANY PARTS OF THE PRODUCT. IN FACT, THE MANUFACTURER AND/OR DISTRIBUTOR EXPRESSLY STATES THAT ALL REPAIRS AND PARTS REPLACEMENTS SHOULD BE UNDERTAKEN BY CERTIFIED AND LICENSED TECHNICIANS, AND NOT BY THE BUYER. THE BUYER ASSUMES ALL RISK AND LIABILITY ARISING OUT OF HIS OR HER REPAIRS TO THE ORIGINAL PRODUCT OR REPLACEMENT PARTS THERETO, OR ARISING OUT OF HIS OR HER INSTALLATION OF REPLACEMENT PARTS THERETO.

Parts List and Diagram

Part	Description	Qty
1	Lamp	1
2	Solar Panel	1
3	Mounting Screw and Anchor	8
4	LED Panel	2
5	Battery Housing	1
6	Motion Detector Head	1
7	Mounting Plate	1
8	Power Switch	1

Part	Description	Qty
9	Solar Power Input	1
10	Solar Panel Mounting Bracket	1
11	LUX Adjusting Knob	1
12	SENS Adjusting Knob	1
13	TIME Adjusting Knob	1
14	Battery (not shown)	1
15	Solar Power Cable (not shown)	1

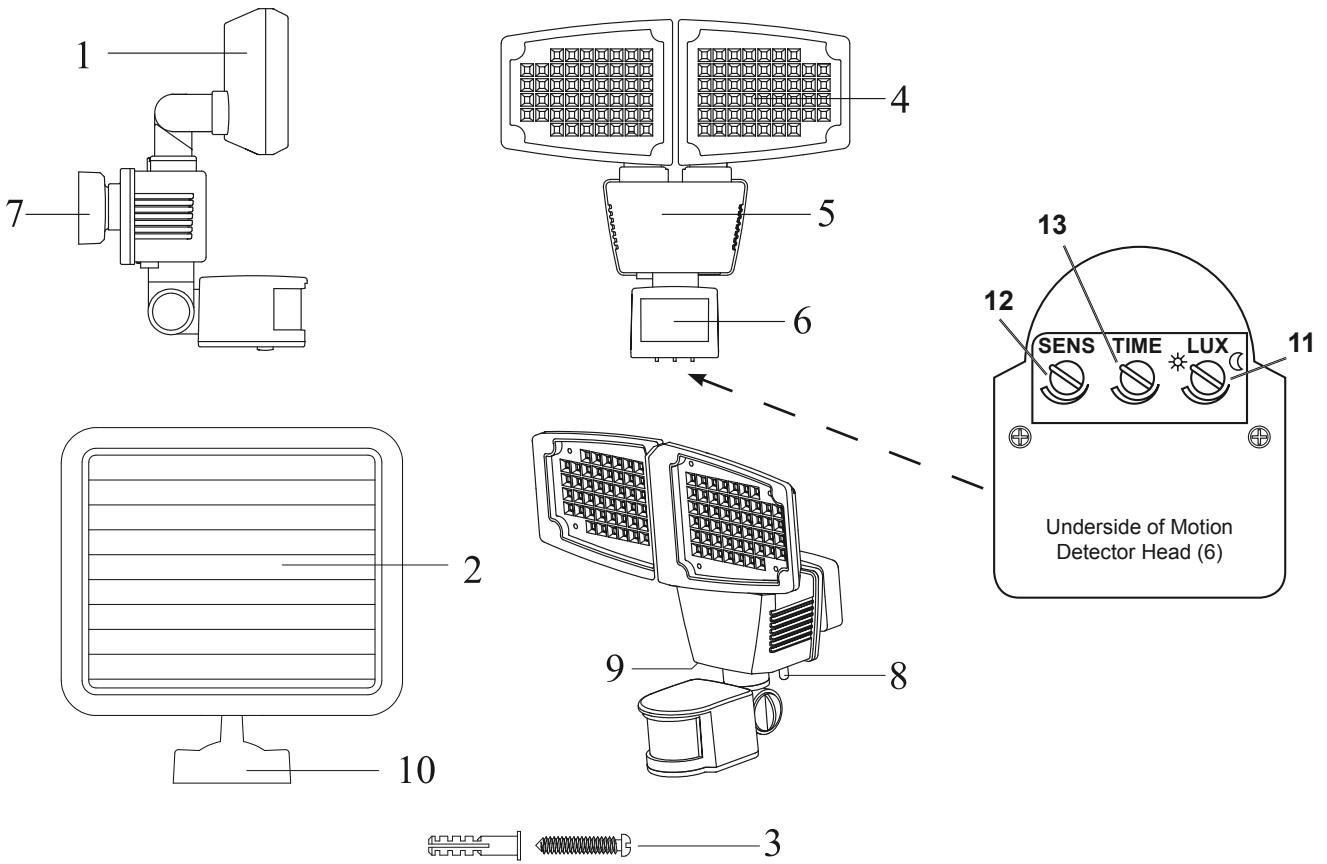

Limited 90 Day Warranty

Harbor Freight Tools Co. makes every effort to assure that its products meet high quality and durability standards, and warrants to the original purchaser that this product is free from defects in materials and workmanship for the period of 90 days from the date of purchase. This warranty does not apply to damage due directly or indirectly, to misuse, abuse, negligence or accidents, repairs or alterations outside our facilities, criminal activity, improper installation, normal wear and tear, or to lack of maintenance. We shall in no event be liable for death, injuries to persons or property, or for incidental, contingent, special or consequential damages arising from the use of our product. Some states do not allow the exclusion or limitation of incidental or consequential damages, so the above limitation of exclusion may not apply to you. THIS WARRANTY IS EXPRESSLY IN LIEU OF ALL OTHER WARRANTIES, EXPRESS OR IMPLIED, INCLUDING THE WARRANTIES OF MERCHANTABILITY AND FITNESS.

To take advantage of this warranty, the product or part must be returned to us with transportation charges prepaid. Proof of purchase date and an explanation of the complaint must accompany the merchandise. If our inspection verifies the defect, we will either repair or replace the product at our election or we may elect to refund the purchase price if we cannot readily and quickly provide you with a replacement. We will return repaired products at our expense, but if we determine there is no defect, or that the defect resulted from causes not within the scope of our warranty, then you must bear the cost of returning the product.

This warranty gives you specific legal rights and you may also have other rights which vary from state to state.

