

# Owner's Manual & Safety Instructions

**Save This Manual** Keep this manual for the safety warnings and precautions, assembly, operating, inspection, maintenance and cleaning procedures. Write the product's serial number in the back of the manual near the assembly diagram (or month and year of purchase if product has no number). Keep this manual and the receipt in a safe and dry place for future reference.

19b

# BRAUN™

## CORDED LED WORK LIGHT



Visit our website at: <http://www.harborfreight.com>  
Email our technical support at: [productsupport@harborfreight.com](mailto:productsupport@harborfreight.com)

64738

When unpacking, make sure that the product is intact and undamaged. If any parts are missing or broken, please call 1-888-866-5797 as soon as possible.





Copyright© 2019 by Harbor Freight Tools®. All rights reserved.

No portion of this manual or any artwork contained herein may be reproduced in any shape or form without the express written consent of Harbor Freight Tools. Diagrams within this manual may not be drawn proportionally. Due to continuing improvements, actual product may differ slightly from the product described herein. Tools required for assembly and service may not be included.

### **⚠WARNING**

Read this material before using this product. Failure to do so can result in serious injury. **SAVE THIS MANUAL.**

## WARNING SYMBOLS AND DEFINITIONS

	This is the safety alert symbol. It is used to alert you to potential personal injury hazards. Obey all safety messages that follow this symbol to avoid possible injury or death.
 <b>DANGER</b>	Indicates a hazardous situation which, if not avoided, will result in death or serious injury.
 <b>WARNING</b>	Indicates a hazardous situation which, if not avoided, could result in death or serious injury.
 <b>CAUTION</b>	Indicates a hazardous situation which, if not avoided, could result in minor or moderate injury.
<b>NOTICE</b> <b>CAUTION</b>	Addresses practices not related to personal injury.

# BRAUN™

INSTRUCTIONS PERTAINING TO A RISK OF FIRE, ELECTRIC SHOCK,  
OR INJURY TO PERSONS.

## IMPORTANT SAFETY INSTRUCTIONS

### **READ ALL INSTRUCTIONS.**

**WARNING:** When using outdoor use portable luminaires, basic safety precautions should always be followed to reduce the risk of fire, electric shock, and personal injury, including the following:

1. Use only three-wire outdoor extension cords that have three-prong grounding plugs and grounding receptacles that accept the appliance's plug.
2. Ground Fault Circuit Interrupter (GFCI) protection is to be provided on the circuit(s) or outlet(s) to be used or the wet location portable luminaire. Receptacles are available having built-in GFCI protection and are able to be used for this measure of safety.
3. Use only with an extension cord for outdoor use, such as an extension cord of cord type SEW, SEOW, SEOOW, SOW, SOOW, STW, STOW, STOOW, SJEW, SJEOW, SJEOWW, SJW, SJOW, SJOOW, SJTW, SJTOW, or SJTOOW.
4. RISK OF ELECTRIC SHOCK, Do not use with an extension cord near water or where water may accumulate. Keep lamp at least 16 feet (5m) from pools and spas. Keep plugs and receptacles dry.
5. Suitable for Wet location Use.
6. Do not operate the portable luminaire with a missing or damaged guard or lamp containment barrier.
7. Do not submerge the Light in water.
8. Do not obstruct walkways or common areas with the cord.
9. Wear ANSI-approved goggles during setup and use.
10. Do not operate the Light in explosive atmospheres, such as in the presence of flammable liquids, gases or dust. The Light generates sparks which may ignite the dust or fumes.
11. Do not abuse the cord. Never use the cord for carrying, pulling or unplugging the Light. Keep cord away from heat, oil, sharp edges or moving parts. Damaged or entangled cords increase the risk of electric shock.
12. Maintain the Light. Check for breakage of parts and any other condition that may affect the Light's operation. If damaged, have it repaired before use. Many accidents are caused by poorly maintained items.

13. Maintain labels and nameplates on the Light. These carry important safety information. If unreadable or missing, contact Harbor Freight Tools for a replacement.
  - Any power cord must be properly grounded. Ground Fault Circuit Interrupter (GFCI) should also be implemented – it prevents sustained electrical shock.
14. Do not leave the Light unattended when it is plugged into an electrical outlet. Unplug it from its electrical outlet before leaving.
15. This product is not a toy. Keep it out of reach of children.
16. People with pacemakers should consult their physician(s) before use. Electromagnetic fields in close proximity to heart pacemaker could cause pacemaker interference or pacemaker failure. In addition, people with pacemakers should:
  - Avoid operating alone.
  - Properly maintain and inspect to avoid electrical shock.
17. The warnings, precautions, and instructions discussed in this instruction manual cannot cover all possible conditions and situations that may occur. It must be understood by the operator that common sense and caution are factors which cannot be built into this product, but must be supplied by the operator.



**SAVE THESE INSTRUCTIONS.**

## ⚠ WARNING



**TO PREVENT ELECTRIC SHOCK AND DEATH FROM INCORRECT GROUNDING WIRE CONNECTION:**

Check with a qualified electrician if you are in doubt as to whether the outlet is properly grounded. Do not modify the power cord plug provided with the Light. Never remove the grounding prong from the plug. Do not use the Light if the power cord or plug is damaged. If damaged, have it repaired by a service facility before use. If the plug will not fit the outlet, have a proper outlet installed by a qualified electrician.

## Grounded Lights: Lights with Three-Prong Plugs

- Lights marked with "Grounding Required" have a three wire cord and a three prong grounding plug. The plug must be connected to a properly grounded outlet. If the Light should electrically malfunction or break down, grounding provides a low resistance path to carry electricity away from the user, reducing the risk of electric shock. (See 3-Prong Plug and Outlet.)
- The grounding prong in the plug is connected through the green wire inside the cord to the grounding system in the Light. The green wire in the cord must be the only wire connected to the Light's grounding system and must never be attached to an electrically "live" terminal. (See 3-Prong Plug and Outlet.)
- The Light must be plugged into an appropriate outlet, properly installed and grounded in accordance with all codes and ordinances. The plug and outlet should look like those in the preceding illustration. (See 3-Prong Plug and Outlet.)

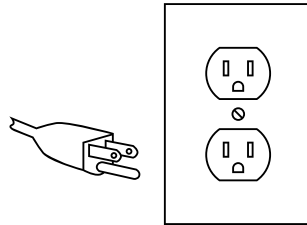

3-Prong Plug and Outlet

## Extension Cords

- Grounded** Lights require a three-wire extension cord. **Double Insulated** Lights can use either a two or three wire extension cord.
- As the distance from the supply outlet increases, you must use a heavier gauge extension cord. Using extension cords with inadequately sized wire causes a serious drop in voltage, resulting in loss of power and possible tool damage. (See Table A.)
- The smaller the gauge number of the wire, the greater the capacity of the cord. For example, a 14 gauge cord can carry a higher current than a 16 gauge cord.
- When using more than one extension cord to make up the total length, make sure each cord contains at least the minimum wire size required.
- If you are using one extension cord for more than one tool, add the nameplate amperes and use the sum to determine the required minimum cord size.
- If you are using an extension cord outdoors, make sure it is marked with the suffix "W-A" ("W" in Canada) to indicate it is acceptable for outdoor use.
- Make sure the extension cord is properly wired and in good electrical condition. Always replace a damaged extension cord or have it repaired by a qualified electrician before using it.
- Protect the extension cords from sharp objects, excessive heat, and damp or wet areas.



NAMEPLATE AMPERES (at full load)	EXTENSION CORD LENGTH				
	25'	50'	75'	100'	150'
0 – 2.0	18	18	18	18	16
2.1 – 3.4	18	18	18	16	14
3.5 – 5.0	18	18	16	14	12
5.1 – 7.0	18	16	14	12	12
7.1 – 12.0	16	14	12	10	-



\* Based on limiting the line voltage drop to five volts at 150% of the rated amperes.

TABLE A: RECOMMENDED MINIMUM WIRE GAUGE FOR EXTENSION CORDS* (120 VOLT)					
NAMEPLATE AMPERES (at full load)	EXTENSION CORD LENGTH				
	25'	50'	75'	100'	150'
12.1 – 16.0	14	12	10	-	-
* Based on limiting the line voltage drop to five volts at 150% of the rated amperes.					

TABLE A: RECOMMENDED MINIMUM WIRE GAUGE FOR EXTENSION CORDS* (120 VOLT)					
NAMEPLATE AMPERES (at full load)	EXTENSION CORD LENGTH				
	25'	50'	75'	100'	150'
16.1 – 20.0	12	10	-	-	-
* Based on limiting the line voltage drop to five volts at 150% of the rated amperes.					

## Symbology

	Double Insulated
<b>VAC</b>	Volts Alternating Current
<b>A</b>	Amperes
n0 xxxx/ min.	No Load Revolutions per Minute (RPM)
	WARNING marking concerning Risk of Eye Injury. Wear ANSI-approved safety goggles with side shields.

	Read the manual before set-up and/or use.
	WARNING marking concerning Risk of Fire. Do not cover ventilation ducts. Keep flammable objects away.
	WARNING marking concerning Risk of Electric Shock. Properly connect power cord to appropriate outlet.

## Specifications

Electrical Rating	120VAC / 60Hz / 10W
-------------------	---------------------

## Setup: Before Use



Read the **ENTIRE IMPORTANT SAFETY INSTRUCTIONS** section at the beginning of this manual, including all text under subheadings therein before setup or use of this product.

## Functions



## Assembly

1. Attach Bracket to Base using Knob.
2. Place Bracket on top of Base. Line up center holes in Base and Bracket.
3. Place Knob through the center hole in the Bracket and screw clockwise into Base until secure. Do not over tighten.

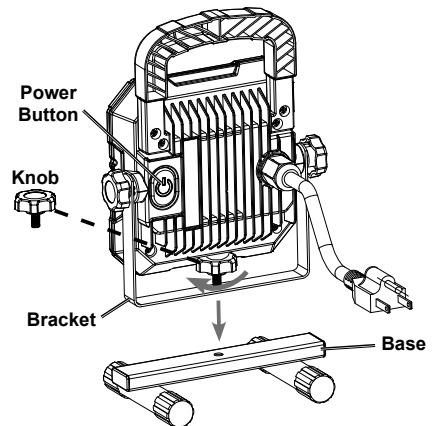

## Operating Instructions



Read the **ENTIRE IMPORTANT SAFETY INSTRUCTIONS** section at the beginning of this manual, including all text under subheadings therein before setup or use of this product.

1. Plug the Work Light into a grounded 120 VAC electrical outlet.
2. Carry Work Light by Handle and place where desired.
3. The Work Light may be tilted if desired.  
To Tilt: Loosen both side Knobs, tilt, tighten Knobs.
4. When ready to use, press Power Button to turn the light on.
5. When done, press Power Button to turn the light off.
6. To prevent accidents, turn off Work Light and disconnect power cord after use. Clean, then store light indoors out of children's reach.



## Maintenance and Servicing



Procedures not specifically explained in this manual must be performed only by a qualified technician.

### **⚠️WARNING**

**TO PREVENT SERIOUS INJURY FROM ACCIDENTAL OPERATION:**

Unplug the tool from its electrical outlet before performing any procedure in this section.

**TO PREVENT SERIOUS INJURY FROM LIGHT FAILURE:**

Do not use damaged equipment. If damage is noted, have the problem corrected before further use.

1. **BEFORE EACH USE**, inspect the general condition of the light. Check for:
  - loose hardware,
  - misalignment or binding of moving parts
  - damaged cord/electrical wiring,
  - cracked or broken parts, and
  - any other condition that may affect its safe operation.
2. **AFTER USE**, wipe external surfaces of the Work Light with a clean cloth.

**⚠️WARNING!** If the power cord of this light is damaged, it must be replaced only by a qualified service technician.

Record Serial Number Here: \_\_\_\_\_

**Note:** If light has no serial number, record month and year of purchase instead.

**Note:** Replacement parts are not available for this item.

## Limited 90 Day Warranty

Harbor Freight Tools Co. makes every effort to assure that its products meet high quality and durability standards, and warrants to the original purchaser that this product is free from defects in materials and workmanship for the period of 90 days from the date of purchase. This warranty does not apply to damage due directly or indirectly, to misuse, abuse, negligence or accidents, repairs or alterations outside our facilities, criminal activity, improper installation, normal wear and tear, or to lack of maintenance. We shall in no event be liable for death, injuries to persons or property, or for incidental, contingent, special or consequential damages arising from the use of our product. Some states do not allow the exclusion or limitation of incidental or consequential damages, so the above limitation of exclusion may not apply to you. THIS WARRANTY IS EXPRESSLY IN LIEU OF ALL OTHER WARRANTIES, EXPRESS OR IMPLIED, INCLUDING THE WARRANTIES OF MERCHANTABILITY AND FITNESS.

To take advantage of this warranty, the product or part must be returned to us with transportation charges prepaid. Proof of purchase date and an explanation of the complaint must accompany the merchandise. If our inspection verifies the defect, we will either repair or replace the product at our election or we may elect to refund the purchase price if we cannot readily and quickly provide you with a replacement. We will return repaired products at our expense, but if we determine there is no defect, or that the defect resulted from causes not within the scope of our warranty, then you must bear the cost of returning the product.

This warranty gives you specific legal rights and you may also have other rights which vary from state to state.

# **BRAUN™**

26541 Agoura Road • Calabasas, CA 91302 • 1-888-866-5797