

# Owner's Manual & Safety Instructions

**Save This Manual** Keep this manual for the safety warnings and precautions, assembly, operating, inspection, maintenance and cleaning procedures. Write the product's serial number in the back of the manual near the assembly diagram (or month and year of purchase if product has no number). Keep this manual and the receipt in a safe and dry place for future reference.

19b

# EARTHQUAKE<sup>XT</sup>

# EQ50<sup>XT</sup>

**64925**



## **3/8" x 50 FT. INDUSTRIAL GRADE AIR HOSE REEL**

Visit our website at: <http://www.harborfreight.com>  
Email our technical support at: [productsupport@harborfreight.com](mailto:productsupport@harborfreight.com)





When unpacking, make sure that the product is intact and undamaged. If any parts are missing or broken, please call 1-888-866-5797 as soon as possible.

Copyright© 2018 by Harbor Freight Tools®. All rights reserved.  
No portion of this manual or any artwork contained herein may be reproduced in any shape or form without the express written consent of Harbor Freight Tools. Diagrams within this manual may not be drawn proportionally. Due to continuing improvements, actual product may differ slightly from the product described herein.  
Tools required for assembly and service may not be included.

### **⚠ WARNING**

Read this material before using this product.  
Failure to do so can result in serious injury.  
**SAVE THIS MANUAL.**

## WARNING SYMBOLS AND DEFINITIONS

	This is the safety alert symbol. It is used to alert you to potential personal injury hazards. Obey all safety messages that follow this symbol to avoid possible injury or death.
	Indicates a hazardous situation which, if not avoided, will result in death or serious injury.
	Indicates a hazardous situation which, if not avoided, could result in death or serious injury.
	Indicates a hazardous situation which, if not avoided, could result in minor or moderate injury.
	Addresses practices not related to personal injury.

## IMPORTANT SAFETY INSTRUCTIONS

### INSTRUCTIONS PERTAINING TO A RISK OF FIRE, ELECTRIC SHOCK, OR INJURY TO PERSONS



**WARNING** – When using tools, basic precautions should always be followed, including the following:

To reduce the risks of electric shock, fire, and injury to persons, read all the instructions before using the tool.

#### Work Area

1. **Keep the work area clean and well lighted.** Cluttered benches and dark areas increase the risks of electric shock, fire, and injury to persons.
2. **Keep bystanders, children, and visitors away while operating the tool.** Distractions are able to result in the loss of control of the tool.

#### Personal Safety

1. **Stay alert. Watch what you are doing and use common sense when operating the tool. Do not use the tool while tired or under the influence of drugs, alcohol, or medication.** A moment of inattention while operating the tool increases the risk of injury to persons.
2. **Dress properly. Do not wear loose clothing or jewelry. Contain long hair. Keep hair, clothing, and gloves away from moving parts.** Loose clothes, jewelry, or long hair increases the risk of injury to persons as a result of being caught in moving parts.
3. **Do not overreach. Keep proper footing and balance at all times.** Proper footing and balance enables better control of the tool in unexpected situations.
4.  **Use safety equipment.** A dust mask, non-skid safety shoes and a hard hat must be used for the applicable conditions.
5.  **Always wear eye protection.** Wear ANSI-approved safety goggles.

#### Tool Use and Care

1. **Do not force the tool.** Use the correct tool for the application. The correct tool will do the job better and safer at the rate for which the tool is designed.
2. **Disconnect the tool from the air source before making any adjustments, changing accessories, or storing the tool.** Such preventive safety measures reduce the risk of starting the tool unintentionally.

3. **Store the tool when it is idle out of reach of children and other untrained persons.**  
A tool is dangerous in the hands of untrained users.
4. **Check for misalignment or binding of moving parts, breakage of parts, and any other condition that affects the tool's operation.** If damaged, have the tool serviced before using. Many accidents are caused by poorly maintained tools. There is a risk of bursting if the tool is damaged.
5. **Use only accessories that are identified by the manufacturer for the specific tool model.** Use of an accessory not intended for use with the specific tool model, increases the risk of injury to persons.

## Service



1. **Tool service must be performed only by qualified repair personnel.**
2. **When servicing a tool, use only identical replacement parts. Use only authorized parts.**
3. **Use only the lubricants supplied with the tool or specified by the manufacturer.**

## Air Source

1.  **Never connect to an air source that is capable of exceeding 200 psi.** Over pressurizing the tool may cause bursting, abnormal operation, breakage of the tool or serious injury to persons.  
Use only clean, dry, regulated compressed air at the rated pressure or within the rated pressure range as marked on the tool. Always verify prior to using the tool that the air source has been adjusted to the rated air pressure or within the rated air-pressure range.
2. **Never use oxygen, carbon dioxide, combustible gases or any bottled gas as an air source for the tool.** Such gases are capable of explosion and serious injury to persons.

## Safety Symbol Definitions

Symbol	Property or statement
<b>PSI</b>	Pounds per square inch of pressure
<b>NPT</b>	National pipe thread, tapered
	WARNING marking concerning Risk of Eye Injury. Wear ANSI-approved eye protection.

Symbol	Property or statement
	WARNING marking concerning Risk of Respiratory Injury. Wear NIOSH-approved dust mask/respirator.
	WARNING marking concerning Risk of Explosion.

## Specific Safety Instructions

1. The warnings and precautions discussed in this manual cannot cover all possible conditions and situations that may occur. It must be understood by the operator that common sense and caution are factors which cannot be built into this product, but must be supplied by the operator.
2. Obey the manual for the air tool and air compressor used with this tool.
3. Install an in-line shutoff valve to allow immediate control over the air supply in an emergency, even if a hose is ruptured.



**SAVE THESE INSTRUCTIONS.**

## Functional Description

## Specifications

Hose Length	50'
Maximum Air Pressure	300 PSI
Air Inlet	3/8" -18 NPT

## Components and Controls

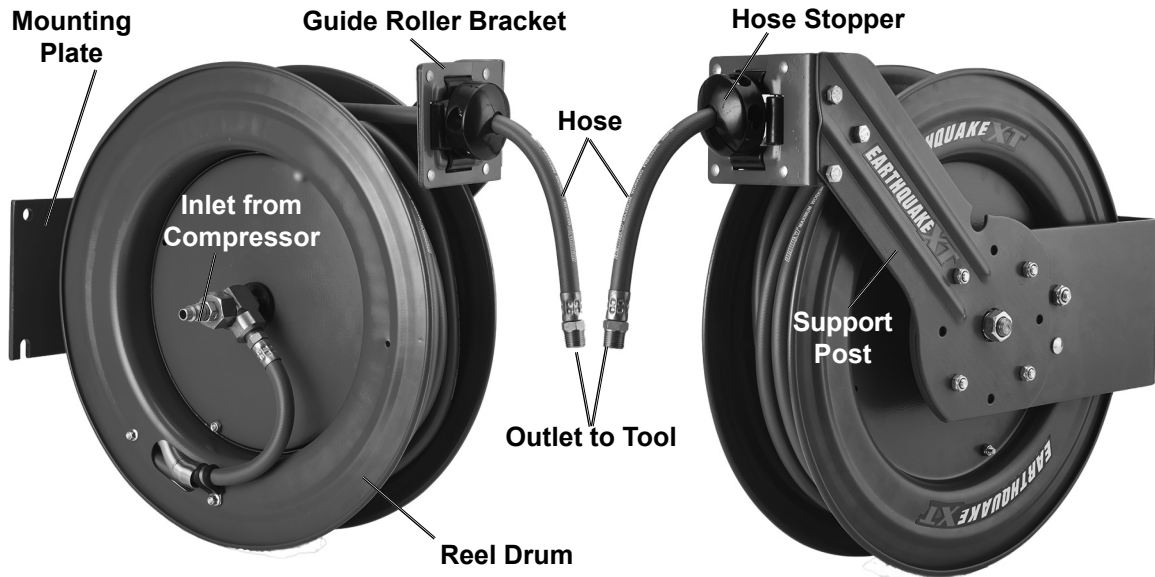

## Initial Hose Reel Setup



Read the **ENTIRE IMPORTANT SAFETY INFORMATION** section at the beginning of this manual including all text under subheadings therein before set up or use of this product.

**Note:** For additional information regarding the parts listed in the following pages, refer to the Assembly Diagram near the end of this manual.

## Repositioning Guide Roller Bracket

1. Remove the four Bolts on the Support Post and reposition the Guide Roller Bracket, if needed, for the desired mounting location (wall, floor, ceiling or under bench).
2. For under bench mounting, position the side notch into the Locking Nut. See Figure C.
3. Replace the four Bolts and tighten.

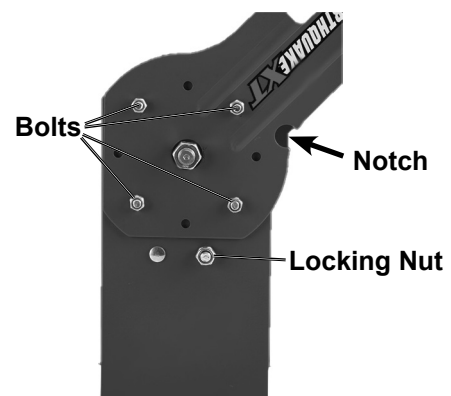

Figure A: Adjusting the Support Post

# Mounting Reel

1. Choose a mounting location that is free of electrical wiring or other obstructions, and is sturdy enough to support the weight of the Reel and hose as well as the force used to extend and retract it.
2. Make a paper template from the Mounting Plate of the Reel. Mark the center of the bolt holes in the desired mounting location.
3. Check for hidden wiring, then, drill holes to accommodate 1/2" bolts (not included).
4. Mount the Reel with the Mounting Plate's holes to the back and secure in place with four bolts.

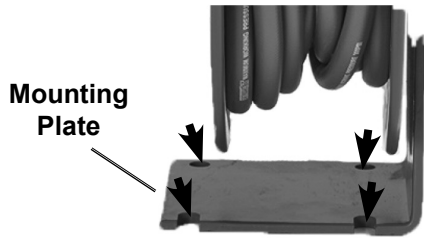

Figure B: Mounting Plate's four bolt holes

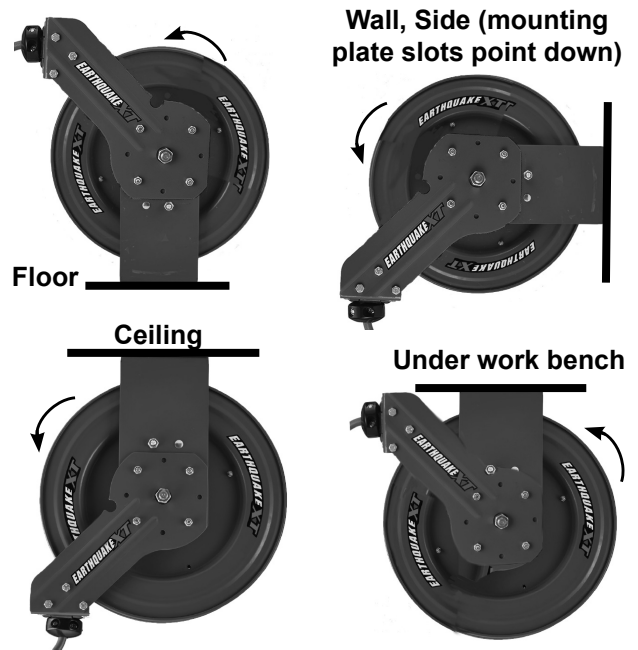

Figure C: Mounting Examples

## Operating Instructions



Read the **ENTIRE IMPORTANT SAFETY INFORMATION** section at the beginning of this manual including all text under subheadings therein before set up or use of this product.

Inspect tool before use, looking for damaged, loose, and missing parts. If any problems are found, do not use tool until repaired.

## Adjust the Spring Tension

**Note:** To improve hose longevity, pressurize hose to operating pressure before extending or retracting.

1. Pull out approximately six feet of Hose.
  - a. To increase tension, wrap the loose hose one time around the Reel Drum.
  - b. To decrease tension, unwrap the hose one time from the drum.
2. Remove the Hose Stopper from the Hose and slide the Hose out of the Guide Roller Bracket so the Hose is hanging loose.
  3. Run the hose back through the guide and re-attach the Hose Stopper.
  4. Pull the Hose out several feet to check the tension.

## General Operating Instructions

**Note:** To improve hose longevity, pressurize hose to operating pressure before extending or retracting.

1. Check the Wheel operation by slowly pulling the Hose out. You should hear a clicking noise.
2. To lock the Hose, pull it out a minimum of 1/2 revolution and it will stay locked after the first, second, or third click.
3. To unlock, slowly pull until the clicking stops, and let it retract until the Hose Stopper hits the guide.
4. Attach a coupler (sold separately) to your air compressor hose and apply thread seal tape to the Inlet fitting on the Reel. Connect the coupler to the Inlet fitting.
5. Connect your air tool to the other end of the Hose using another coupler and thread seal tape.
6. Follow all instructions from the air tool and compressor for set up and use.
7. When finished using the Hose, disconnect the air tool and retract the hose. Wipe the Hose Reel clean with a dry cloth.

**NOTICE:** Hold on to the Hose while it is rewinding, to avoid damage to the Hose Reel.

## User-Maintenance Instructions



Procedures not specifically explained in this manual must be performed only by a qualified technician.

### **WARNING**

#### TO PREVENT SERIOUS INJURY:

Detach air supply from this product before performing any inspection, maintenance, or cleaning procedures.

#### TO PREVENT SERIOUS INJURY FROM TOOL FAILURE:

Do not use damaged equipment. If abnormal noise, vibration, or leaking air occurs, have the problem corrected before further use.

## Cleaning, Maintenance, and Lubrication

**Note:** These procedures are in addition to the regular checks and maintenance explained as part of the regular operation of the Hose Reel.

1. **BEFORE EACH USE**, inspect the general condition of the tool. Check for:
  - loose hardware or housing,
  - misalignment or binding of moving parts,
  - cracked or broken parts, and
  - any other condition that may affect its safe operation.
2. **AFTER EACH USE**, re-wind the Hose onto the reel and wipe clean the Hose Reel with a dry cloth.

**WARNING!** Internal spring is not user-serviceable or user-replaceable.

## Hose Replacement

1. Remove the Hose Stopper from the Hose and set aside.
2. Pull out the old Hose and securely lock the Hose Reel.
3. Disconnect the old hose from the swivel joint and remove the Hose.
4. Run the new Hose through the Guide Roller and through the opening in the drum flange.
5. Use thread seal tape on the hose fitting threads and screw the fitting onto the swivel and tighten.
6. Attach the Hose Stopper on the end of the Hose near the Outlet fitting.
7. Carefully release the Drum Latch and allow the Hose to wind onto the reel, evenly distributing the Hose across the Reel.

**Note:** Make sure the Hose Reel is securely locked and will not rotate backwards.

# Parts List and Diagram

Part	Description	Qty
1	Guide Roller Bracket	1
2	Long Axis Roller	2
3	Wide Roller	2
4	Large Roller	2
5	Short Axis Roller	2
6	Rivet	4
7	Roller Base	1
8	Nut M6	11
9	Hex Screw M8	3
10	Support Post	1
11	Nut M8	7
12	Nut M16	1
13	Spring Washer M16	1
14	Screw	4
15	Mounting Plate	1
16	Nut M10	1
17	Clutch Spring Holder	1
18	Nut M10	1
19	Washer	1
20	Clutch Spring	1
21	Bushing	1
22	Clutch Pawl	1
23	Clutch Screw	1
24	Steel Axle	1
25	Clutch Plate	1
26	Clutch Plate Base	1

Part	Description	Qty
27	Reel Drum, Left	1
28	Reel Drum, Right	1
29	Nut M5	2
30	Hose Clamp	2
31	Screw M5	2
32	Screw	3
33	Drum Cover Base	1
34	Nut M6	1
35	Drive Spring Holder	2
36	Drive Spring	1
37	Drive Spring Cover	1
38	Spring Retainer Screw	4
39	Washer	1
40	Retainer Ring	2
41	Air Inlet	1
42	O-Ring	2
43	Screw	1
44	Inlet Axle Filling Swivel Base	1
45	Outlet, Brass Fitting 3/8"	2
46	Brass Ferrule	2
47	Spring Guard	1
48	Hose	1
49	Bend Restrictor	1
50	Hose Stopper	1
51	Screw M8	2

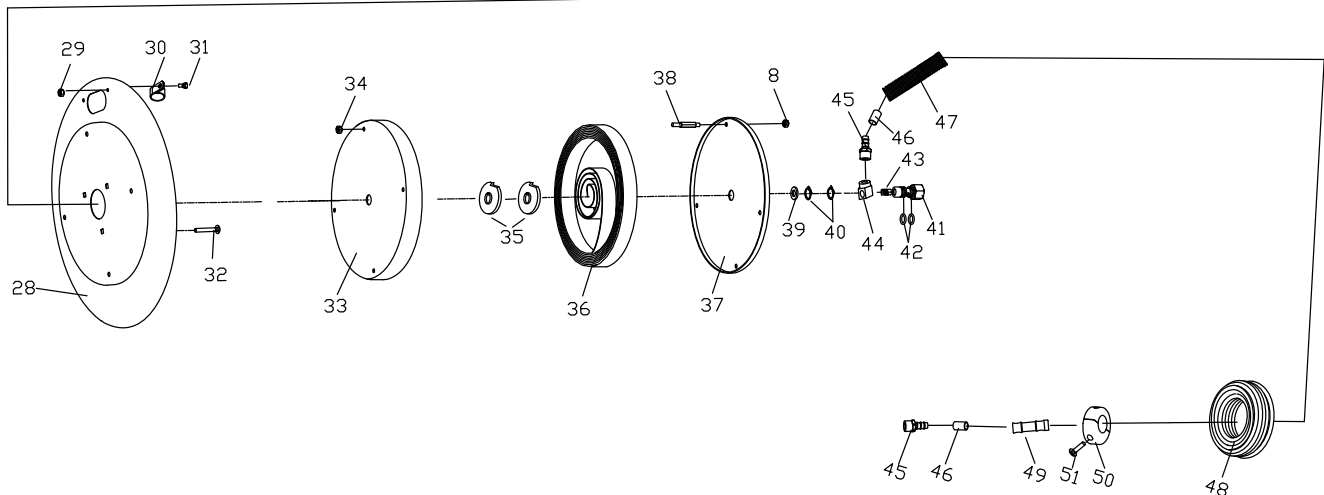
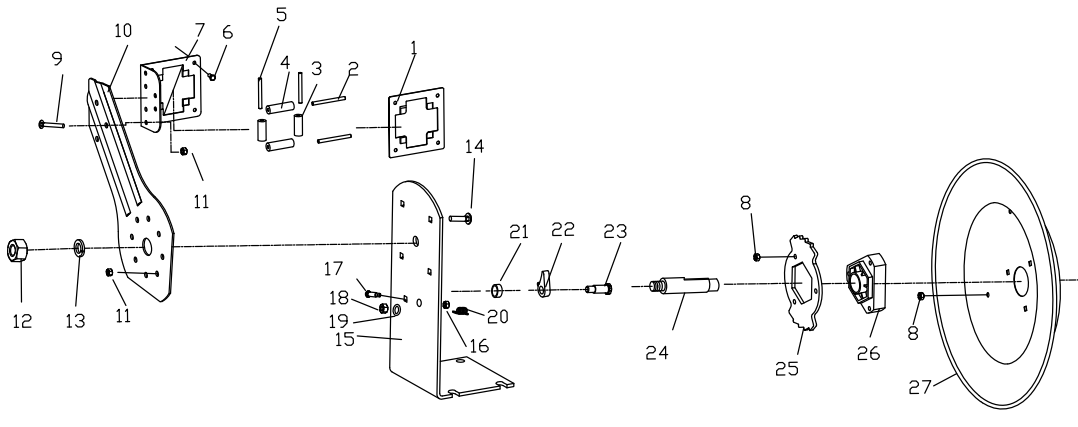

SAFETY

SETUP

OPERATION

MAINTENANCE

## Limited 90 Day Warranty

Harbor Freight Tools Co. makes every effort to assure that its products meet high quality and durability standards, and warrants to the original purchaser that this product is free from defects in materials and workmanship for the period of 90 days from the date of purchase. This warranty does not apply to damage due directly or indirectly, to misuse, abuse, negligence or accidents, repairs or alterations outside our facilities, criminal activity, improper installation, normal wear and tear, or to lack of maintenance. We shall in no event be liable for death, injuries to persons or property, or for incidental, contingent, special or consequential damages arising from the use of our product. Some states do not allow the exclusion or limitation of incidental or consequential damages, so the above limitation of exclusion may not apply to you. THIS WARRANTY IS EXPRESSLY IN LIEU OF ALL OTHER WARRANTIES, EXPRESS OR IMPLIED, INCLUDING THE WARRANTIES OF MERCHANTABILITY AND FITNESS.

To take advantage of this warranty, the product or part must be returned to us with transportation charges prepaid. Proof of purchase date and an explanation of the complaint must accompany the merchandise. If our inspection verifies the defect, we will either repair or replace the product at our election or we may elect to refund the purchase price if we cannot readily and quickly provide you with a replacement. We will return repaired products at our expense, but if we determine there is no defect, or that the defect resulted from causes not within the scope of our warranty, then you must bear the cost of returning the product.

This warranty gives you specific legal rights and you may also have other rights which vary from state to state.

## PLEASE READ THE FOLLOWING CAREFULLY

---

THE MANUFACTURER AND/OR DISTRIBUTOR HAS PROVIDED THE PARTS LIST AND ASSEMBLY DIAGRAM IN THIS MANUAL AS A REFERENCE TOOL ONLY. NEITHER THE MANUFACTURER OR DISTRIBUTOR MAKES ANY REPRESENTATION OR WARRANTY OF ANY KIND TO THE BUYER THAT HE OR SHE IS QUALIFIED TO MAKE ANY REPAIRS TO THE PRODUCT, OR THAT HE OR SHE IS QUALIFIED TO REPLACE ANY PARTS OF THE PRODUCT. IN FACT, THE MANUFACTURER AND/OR DISTRIBUTOR EXPRESSLY STATES THAT ALL REPAIRS AND PARTS REPLACEMENTS SHOULD BE UNDERTAKEN BY CERTIFIED AND LICENSED TECHNICIANS, AND NOT BY THE BUYER. THE BUYER ASSUMES ALL RISK AND LIABILITY ARISING OUT OF HIS OR HER REPAIRS TO THE ORIGINAL PRODUCT OR REPLACEMENT PARTS THERETO, OR ARISING OUT OF HIS OR HER INSTALLATION OF REPLACEMENT PARTS THERETO.

**Record Product's Serial Number Here:** \_\_\_\_\_

**Note:** If product has no serial number, record month and year of purchase instead.

**Note:** Some parts are listed and shown for illustration purposes only, and are not available individually as replacement parts.

