

# Owner's Manual & Safety Instructions

**Save This Manual** Keep this manual for the safety warnings and precautions, assembly, operating, inspection, maintenance and cleaning procedures. Write the product's serial number in the back of the manual near the assembly diagram (or month and year of purchase if product has no number). Keep this manual and the receipt in a safe and dry place for future reference.

20h

## CENTRALPNEUMATIC®

### 5GAL portable air tank



65594 shown.

Visit our website at: <http://www.harborfreight.com>  
Email our technical support at: [productsupport@harborfreight.com](mailto:productsupport@harborfreight.com)

65594 65595

When unpacking, make sure that the product is intact and undamaged. If any parts are missing or broken, please call 1-888-866-5797 as soon as possible.





Copyright© 2020 by Harbor Freight Tools®. All rights reserved.  
No portion of this manual or any artwork contained herein may be reproduced in any shape or form without the express written consent of Harbor Freight Tools. Diagrams within this manual may not be drawn proportionally. Due to continuing improvements, actual product may differ slightly from the product described herein. Tools required for assembly and service may not be included.

#### ⚠ WARNING



Read this material before using this product. Failure to do so can result in serious injury. SAVE THIS MANUAL.

# CENTRALPNEUMATIC®

## WARNING SYMBOLS AND DEFINITIONS

	This is the safety alert symbol. It is used to alert you to potential personal injury hazards. Obey all safety messages that follow this symbol to avoid possible injury or death.
	Indicates a hazardous situation which, if not avoided, will result in death or serious injury.
	Indicates a hazardous situation which, if not avoided, could result in death or serious injury.
	Indicates a hazardous situation which, if not avoided, could result in minor or moderate injury.
	Addresses practices not related to personal injury.

Symbol	Property or statement
<b>PSI</b>	Pounds per square inch of pressure
<b>NPT</b>	National pipe thread, tapered
<b>NPS</b>	National pipe thread, straight

Symbol	Property or statement
	WARNING marking concerning Risk of Eye Injury. Wear ANSI-approved eye protection.
	WARNING marking concerning Risk of Hearing Loss. Wear hearing protection.
	WARNING marking concerning Risk of Explosion.

## IMPORTANT SAFETY INSTRUCTIONS

### INSTRUCTIONS PERTAINING TO A RISK OF FIRE, ELECTRIC SHOCK, OR INJURY TO PERSONS

**WARNING** – When using air tanks, basic precautions should always be followed, including the following:

#### General Safety

1. To reduce the risks of explosion and injury to persons, read all the instructions before using the air tank.
2. The warnings and precautions discussed in this manual cannot cover all possible conditions and situations that may occur. It must be understood by the operator that common sense and caution are factors which cannot be built into this product, but must be supplied by the operator.

# Pressurized Tank Handling Safety

---

## PRESSURIZED TANKS CAN EXPLODE WHEN DAMAGED.

1. **Protect pressurized or closed tanks from heat, being struck, physical damage, flames, and sparks.**
2. **Always use proper procedures to move pressurized tanks.**

## Personal Safety

---

1. **Stay alert. Watch what you are doing and use common sense when filling or using the air tank. Do not fill or use the air tank while tired or under the influence of drugs, alcohol, or medication.**
2. **Always wear eye protection.**  
Wear ANSI-approved safety goggles.
3. **Always wear hearing protection when using the air tank.** Prolonged exposure to high intensity noise is able to cause hearing loss.

## Use Safety

---

1. **Keep the air tank when it is full out of reach of children and other untrained persons.**  
A air tank is dangerous in the hands of untrained users.
2. **Check for breakage of parts and any other condition that affects the air tank's operation.**  
If damaged, have the air tank serviced before using. Many accidents are caused by poorly maintained air tanks. There is a risk of bursting if the air tank is damaged.

## Service

---

1. **Air tank service must be performed only by qualified repair personnel.**
2. **When servicing a air tank, use only identical replacement parts. Use only authorized parts.**
3. **Maintain the air tank with care.**
4. **Safely discharge all air pressure from the air tank before storing the air tank.**

## Air Source

---

1.  **Never connect to an air source that is capable of exceeding 200 psi.**  
Over pressurizing the air tank may cause bursting, abnormal operation, breakage of the air tank or serious injury to persons. Use only clean, dry, regulated compressed air at the rated pressure or within the rated pressure range as marked on the air tank. Always verify prior to filling the air tank that the air source has been adjusted to the rated air pressure or within the rated air-pressure range.
2. **Never use oxygen, carbon dioxide, combustible gases or any bottled gas as an air source for the air tank.** Such gases are capable of explosion and serious injury to persons.
3. Obey the manual for the air compressor used to power this air tank.



**SAVE THESE INSTRUCTIONS.**

## Specifications

Tank Capacity	<b>65594:</b> 5 Gallons	<b>65595:</b> 11 Gallons
Max. Air Pressure	125 PSI	
Hose Length	3'	

## Operating Instructions



Read the **ENTIRE IMPORTANT SAFETY INFORMATION** section at the beginning of this manual including all text under subheadings therein before set up or use of this product.

Inspect air tank before use, looking for damaged, loose, and missing parts. If any problems are found, do not use air tank until repaired.

## Filling the Tank

### **WARNING**



**TO PREVENT SERIOUS INJURY FROM EXPLOSION:**

Use only clean, dry, regulated, compressed air to fill this air tank. Do not use oxygen, carbon dioxide, combustible gases, or any other bottled gas to fill this air tank.

1. Take your Air Tank to any source of clean and dry compressed air.
2. Attach air hose from the pressurized air source to the air fitting on the Manifold (4).
3. Begin pumping air into the Air Tank.
4. Monitor the Pressure Gauge (3) as you fill the Air Tank. Fill as needed, but do not exceed 125 PSI. **WARNING! TO PREVENT SERIOUS INJURY: Do not overfill tank.**

## Releasing Air From Tank

1. Turn the round On/Off Wheel (5) counter-clockwise to the open position. This allows air to flow from the Air Tank (1) through the Air Hose (2).
2. Next place Outlet Valve at the end of the Air Hose (2) over the valve of the object to be inflated.
3. Once the pin inside the Outlet Valve is depressed, air will begin to flow out from the Air Tank into the object being inflated. Once you are finished inflating air into the object, remove the Outlet Valve and the air will stop being released from tank.
4. If the Tank will not be used for long period of time, expel air inside Tank and hose. Store in clean and dry location away from children.

**WARNING! Do not overinflate. Do not exceed the maximum pressure rating of any inflatable object. Check pressure frequently during inflation. The Air Tank should be examined periodically. If any damage to the welds is noted do not use the tank.**

# CENTRALPNEUMATIC®

## User-Maintenance Instructions



Procedures not specifically explained in this manual must be performed only by a qualified technician.

### **!WARNING**

#### **TO PREVENT SERIOUS INJURY FROM ACCIDENTAL OPERATION:**

Disconnect the Air Tank and safely discharge any residual air pressure in the air tank before performing any inspection, maintenance, or cleaning procedures.

#### **TO PREVENT SERIOUS INJURY FROM AIR TANK FAILURE:**

Do not use damaged equipment. If abnormal noise, vibration, or leaking air occurs, have the problem corrected before further use.

## Cleaning, Maintenance, and Lubrication

---

**Note:** These procedures are in addition to the regular checks and maintenance explained as part of the regular operation of the air tank.

1. **BEFORE EACH USE**, inspect the general condition of the air tank. Check for:
  - loose hardware or housing,
  - misalignment or binding of moving parts,
  - cracked or broken parts, and
  - any other condition that may affect its safe operation.
2. Regularly drain water condensation from Tank, to prevent internal corrosion and damage to the tank. To drain, hold Tank upside down and remove the Bypass Valve Spring (2).
3. Due to internal corrosion, do not use the tank beyond the destroy date stamped into the leg of the Tank (1). Safely disable the tank as follows:
  - a. Depressurize air tank completely, by holding the Bypass Valve Spring open.

**WARNING!** Failure to properly depressurize the tank before proceeding may result in serious personal injury.

- b. Remove the pressure gauge and hose.
- c. Deliver the tank to a pressure tank disposal service, if available.
- d. If a pressure tank disposal service is not available, place the tank in a secure, stable working location and drill at least two 1/2" (or larger) holes through the side of the tank. Then, deliver to appropriate recycling center.

## Storage

---

1. Turn the round On/Off Wheel (5) clockwise to the Off position. This will keep air from leaking out of Air Hose.
2. Store in a dry, dust-free location away from children and any flammable materials.
3. To remove all air from the Air Tank, pull the Ring (13) until the Gauge indicates zero and the air flow stops.

**PLEASE READ THE FOLLOWING CAREFULLY**

THE MANUFACTURER AND/OR DISTRIBUTOR HAS PROVIDED THE PARTS LIST AND ASSEMBLY DIAGRAM IN THIS MANUAL AS A REFERENCE TOOL ONLY. NEITHER THE MANUFACTURER OR DISTRIBUTOR MAKES ANY REPRESENTATION OR WARRANTY OF ANY KIND TO THE BUYER THAT HE OR SHE IS QUALIFIED TO MAKE ANY REPAIRS TO THE PRODUCT, OR THAT HE OR SHE IS QUALIFIED TO REPLACE ANY PARTS OF THE PRODUCT. IN FACT, THE MANUFACTURER AND/OR DISTRIBUTOR EXPRESSLY STATES THAT ALL REPAIRS AND PARTS REPLACEMENTS SHOULD BE UNDERTAKEN BY CERTIFIED AND LICENSED TECHNICIANS, AND NOT BY THE BUYER. THE BUYER ASSUMES ALL RISK AND LIABILITY ARISING OUT OF HIS OR HER REPAIRS TO THE ORIGINAL PRODUCT OR REPLACEMENT PARTS THERETO, OR ARISING OUT OF HIS OR HER INSTALLATION OF REPLACEMENT PARTS THERETO.

Part	Description	Qty.
1	Air Tank	1
2	Air Hose	1
3	Gauge	1
4	Manifold	1
5	Wheel	1
6	O-ring	2
7	Tire Valve	1
8	E-Ring	1
9	Valve Core	1
10	Spring	1
11	Regulator	1
12	Discharge Valve	1
13	Ring	1

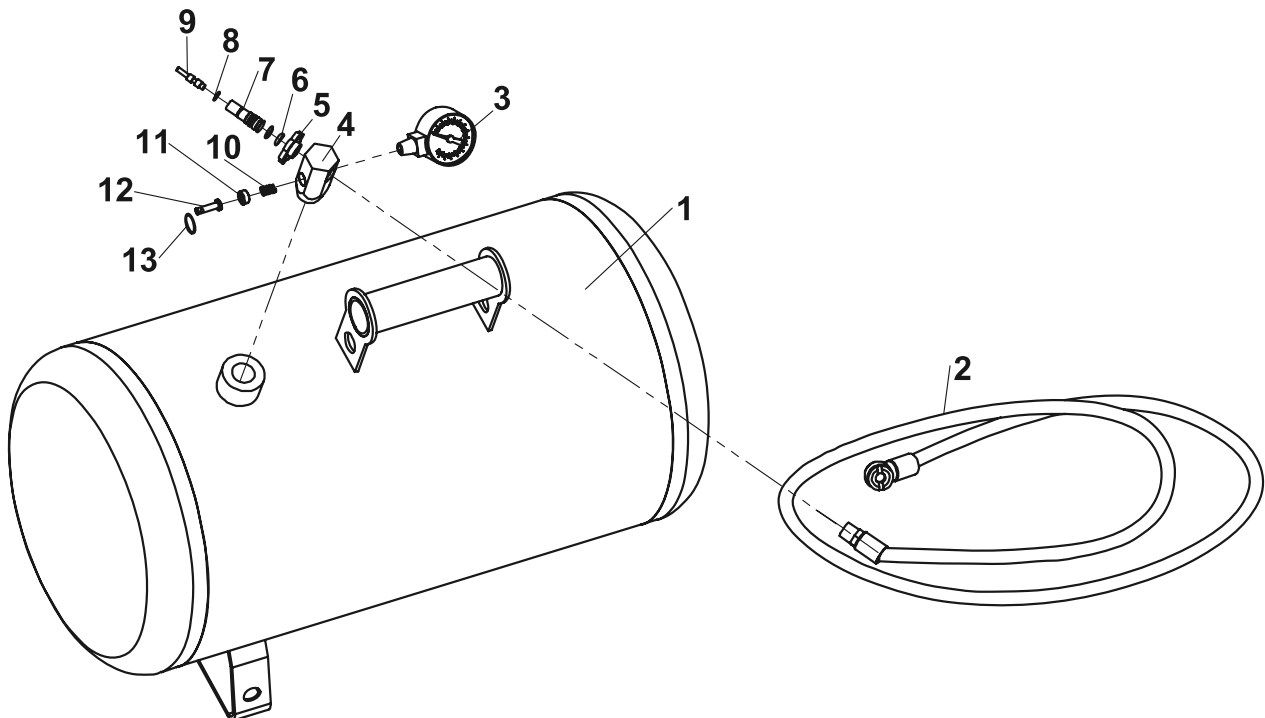

**Record Product's Serial Number Here:** \_\_\_\_\_

**Note:** If product has no serial number, record month and year of purchase instead.

**Note:** Some parts are listed and shown for illustration purposes only, and are not available individually as replacement parts.

**Note:** Parts may not be interchangeable. Specify UPC number when ordering:

5 Gallons: 193175346926

11 Gallons: 193175346933

## Limited 90 Day Warranty

Harbor Freight Tools Co. makes every effort to assure that its products meet high quality and durability standards, and warrants to the original purchaser that this product is free from defects in materials and workmanship for the period of 90 days from the date of purchase. This warranty does not apply to damage due directly or indirectly, to misuse, abuse, negligence or accidents, repairs or alterations outside our facilities, criminal activity, improper installation, normal wear and tear, or to lack of maintenance. We shall in no event be liable for death, injuries to persons or property, or for incidental, contingent, special or consequential damages arising from the use of our product. Some states do not allow the exclusion or limitation of incidental or consequential damages, so the above limitation of exclusion may not apply to you. THIS WARRANTY IS EXPRESSLY IN LIEU OF ALL OTHER WARRANTIES, EXPRESS OR IMPLIED, INCLUDING THE WARRANTIES OF MERCHANTABILITY AND FITNESS.

To take advantage of this warranty, the product or part must be returned to us with transportation charges prepaid. Proof of purchase date and an explanation of the complaint must accompany the merchandise. If our inspection verifies the defect, we will either repair or replace the product at our election or we may elect to refund the purchase price if we cannot readily and quickly provide you with a replacement. We will return repaired products at our expense, but if we determine there is no defect, or that the defect resulted from causes not within the scope of our warranty, then you must bear the cost of returning the product.

This warranty gives you specific legal rights and you may also have other rights which vary from state to state.

# CENTRALPNEUMATIC®

**CENTRALPNEUMATIC®**

26541 Agoura Road • Calabasas, CA 91302 • 1-888-866-5797