

Owner's Manual & Safety Instructions

Save This Manual Keep this manual for the safety warnings and precautions, assembly, operating, inspection, maintenance and cleaning procedures. Write the product's serial number in the back of the manual near the assembly diagram (or month and year of purchase if product has no number). Keep this manual and the receipt in a safe and dry place for future reference.

17e

HaulMaster®

ALUMINUM MOBILITY Wheelchair and Scooter CARRIER



Visit our website at: <http://www.harborfreight.com>
Email our technical support at: productsupport@harborfreight.com

67599

When unpacking, make sure that the product is intact and undamaged. If any parts are missing or broken, please call 1-888-866-5797 as soon as possible.

Copyright© 2012 by Harbor Freight Tools®. All rights reserved.

No portion of this manual or any artwork contained herein may be reproduced in any shape or form without the express written consent of Harbor Freight Tools. Diagrams within this manual may not be drawn proportionally. Due to continuing improvements, actual product may differ slightly from the product described herein. Tools required for assembly and service may not be included.

⚠ WARNING

**Read this material before using this product.
Failure to do so can result in serious injury.
SAVE THIS MANUAL.**

Specifications

Load Capacity	500 lb.
Vehicle Hitch Receiver Size	2" - Class III or better hitches
Inside Platform	47" L x 27-5/8" W x 7-1/2" H
Exterior Platform	49-7/8" L x 29-1/2" W x 8-1/2" H
Removable Ramp	41-1/2" L x 27-3/4" W x 1-1/2" H
Overall Dimensions w/ ramp up	50" L x 40-1/2" W x 43-1/2" H

Important Safety Information

Specific Safety Rules

1. Do not ride in vehicle being loaded or unloaded. Load and unload vehicle slowly, according to manual instructions.
2. Do not use if carrier is higher than 12.5" from bottom of ramp.
3. Follow DOT guidelines for use.
4. Do not exceed 500 lb. capacity. Be aware of dynamic loading! Sudden load movement may briefly create excess load causing product failure.
5. Do not exceed 55 MPH while carrier is attached.
6. Remove ramp and secure load before moving.
7. Turn vehicle's ignition OFF and set parking brake before loading or unloading.
8. Keep ramp clean.
9. This product is not a toy. Do not allow children to play with or near this item.
10. Use as intended only.
11. Inspect before every use; do not use if parts are loose or damaged.
12. Wear ANSI-approved safety goggles and heavy-duty work gloves during use. Prior to transporting a load make sure the Ramp of the Carrier is in its upright position and locked in place with the Pins and Lock Pins.
13. Both feet of the Carrier's Ramp must rest flat on a solid, level, and flat surface when loading and unloading an object.
14. Only use the Carrier with a properly installed Class III or better 2 inch hitch receiver capable of supporting the Carrier and its load.
15. Maintain product labels and nameplates. These carry important safety information. If unreadable or missing, contact Harbor Freight Tools for a replacement.

General safety

1. Make sure the area in which the Carrier is assembled is clean and well lit. *Cluttered or dark areas invite accidents.*
2. Keep children and bystanders away while assembling the Carrier.
3. Stay alert, watch what you are doing and use common sense when using the Carrier. Do not use the Carrier while you are tired or under the influence of drugs, alcohol or medication. *A moment of inattention while using the Carrier may result in serious personal injury.*

Carrier use and care

1. Use the correct Carrier for your application. *The correct Carrier will do the job better and safer at the rate for which it was designed.*
2. Store the Carrier out of reach of children and do not allow people unfamiliar with the Carrier or these instructions to use the Carrier. *Use of carrier by untrained people may not be safe.*
3. Maintain the Carrier. Check for misalignment or binding of moving parts, breakage of parts and any other condition that may affect the Carrier's operation. If damaged, have the Carrier repaired before use. *Many accidents are caused by poorly maintained equipment.*
4. Use this Carrier in accordance with these instructions and in the manner intended for this particular type of product, taking into account the area conditions and the task to be performed. *Use of this Carrier for operations different from those intended could result in a hazardous situation.*
5. **To prevent fire and heat damage to carrier and cargo, DO NOT install near vehicle exhaust. Carrier may not be compatible with vehicles with rear-facing exhaust.**

Service

Have this Carrier serviced by a qualified repair person using only identical replacement parts. *This will ensure that the safety of the Carrier is maintained.*



SAVE THESE INSTRUCTIONS.

Assembly



Read the **ENTIRE IMPORTANT SAFETY INFORMATION** section at the beginning of this manual including all text under subheadings therein before set up or use of this product.

Note: For additional information regarding the parts listed in the following pages, refer to Parts List and Assembly Diagram on page 11.

1. Set Bed (1) on a flat, secure work area able to support weight of Carrier.
2. Use Small Bolts (12) and Nuts (13) to connect all supports (5-8) to Bed. See Figure 1.

Note: Do not fully tighten Bolts and make sure Supports With Reflector (6) are on the same side.

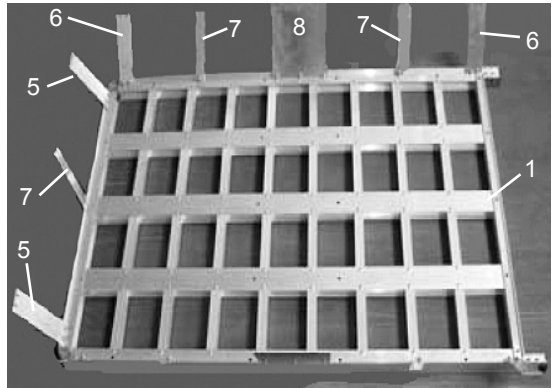

Figure 1

3. Use the small Bolts and Nuts to connect the U-Brace (2) to the top of the Supports. See Figure 2.

Note: Make sure the ends of the U-Brace face the open side.

4. Use a wrench and/or screwdriver (sold separately) to tighten all Bolts and Nuts until the Carrier Bed frame is secure.

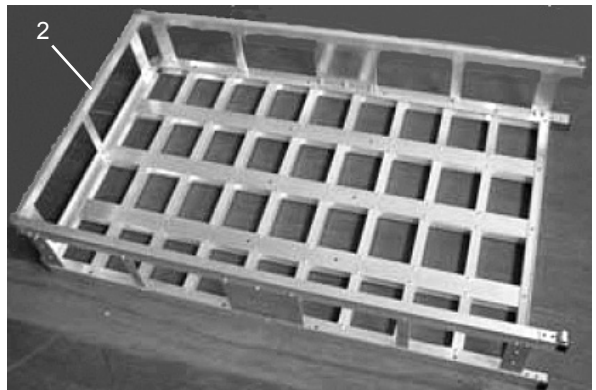

Figure 2

5. With assistance, flip over the Carrier Bed frame and use Medium Bolts (14), Washers (15, 23) and Nuts (16) to fasten the Hitch Bar (9) to the Carrier Bed's underside.
See Figure 3.

Note: Make sure the Hitch Bar extension is OPPOSITE the side of the Bed with the reflectors.

Note: Make sure all Bolts are tightened securely.

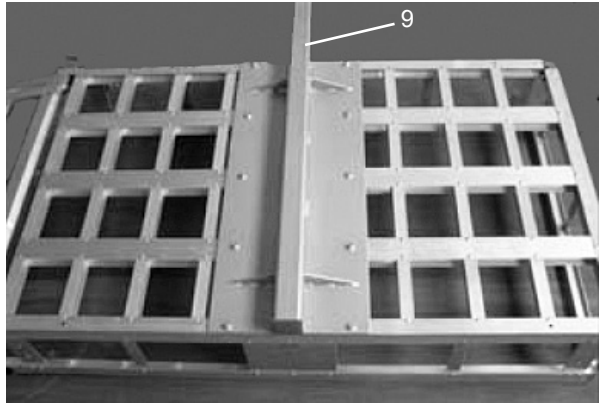

Figure 3

6. Use the Washers (20) and Nuts (21) to attach a Tie-Down Hook (19) to each corner of the Carrier Bed. See Figure 4.

Note: Make sure all Bolts are tightened securely.

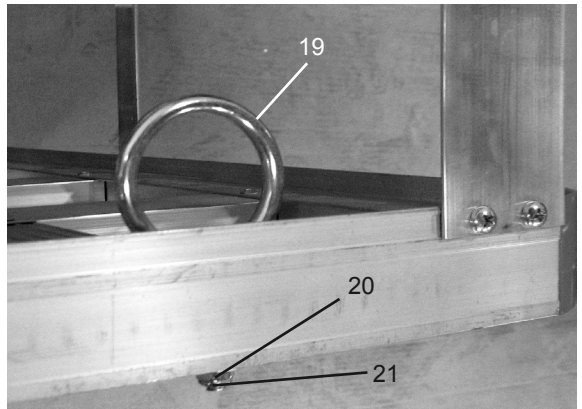

Figure 4

7. Use Large Bolts (17) and Lock Nuts (18) to attach Ramp (3) to open side of the Carrier Bed. See Figure 5.

Note: Do not overtighten connections. There should be enough give to allow Ramp to pivot freely.

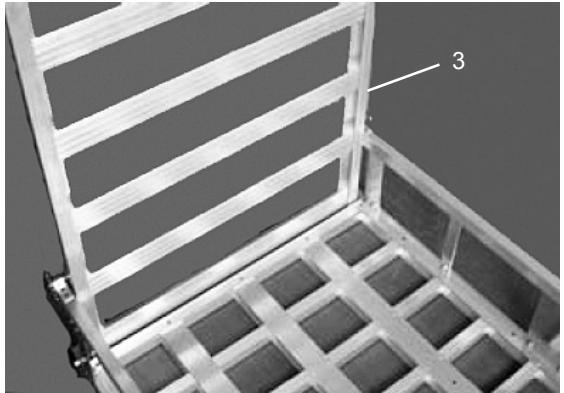

Figure 5

8. Swing the Ramp up, and use the Pins (4) and Lock Pins (22) to lock Ramp in upright position. See Figure 6.
9. With assistance, lift Carrier up and insert Hitch Bar into vehicle's receiver hitch. Align hole in Hitch Bar with hole in vehicle's receiver hitch.
10. Insert Hitch Pin (10) through holes in both hitches and fasten in place using Hitch Lock Pin (11).



Figure 6

Functions

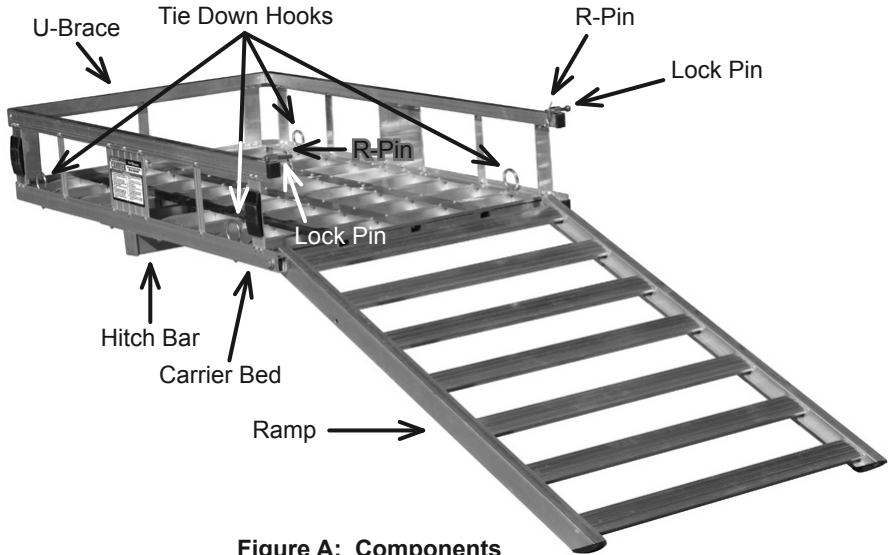

Figure A: Components

Operation Instructions



Read the **ENTIRE IMPORTANT SAFETY INFORMATION** section at the beginning of this document including all text under subheadings therein before set up or use of this product.

⚠ DANGER

To prevent serious injury and **DEATH**:

Do not ride a vehicle while loading or unloading. An unbalanced vehicle being ridden up a steep angle can tip over, causing serious injury or **DEATH**.

Make sure the vehicle is turned off and in gear or park, with the emergency brake engaged and the wheels blocked before loading.

Make sure the Carrier is secured onto the vehicle.

Make sure the Carrier is clean and dry before loading.

Loading

WARNING! Do not exceed this Carrier's maximum weight capacity of 500 pounds.

1. Once the Carrier is fastened to the hitch, lower the Ramp. Do this by removing the Lock Pins and Pins, which unlocks the Ramp from the Body. Lower the Ramp to the ground.

CAUTION! Make sure the feet of the Ramp rest flat on a solid, level surface during the loading and unloading of Wheelchair or Scooter.

Note: Loading from a raised, flat, level surface, like a sidewalk, will lessen the angle of the ramp and make loading easier and safer.

2. With assistance, push the Wheelchair/ Scooter up the Ramp and onto the Carrier Bed. Make sure the load is centered on the Carrier.

3. Secure Wheelchair/Scooter in place using appropriate tie-downs or ropes (sold separately). Fasten tie-downs or ropes to the Tie-Down Hooks.
4. Once the load is secure, swing the Ramp up. Lock in place, using Lock Pins and Pins.
5. The load (wheelchair, scooter, ATV, etc.) can now be transported.

NOTICE! Contact local Department of Transportation to verify all safety guidelines are being followed before transporting load.

WARNING! Do not transport without locking Ramp to Carrier.

DANGER! Do not ride on Wheelchair, Scooter or other vehicle that is being loaded onto or unloaded from the Carrier.

Unloading

1. To unload the vehicle, untie the tie-downs or ropes from the Tie Down Hooks, unlock and lower the Ramp.
2. With assistance, carefully unload Wheelchair/Scooter from Carrier. Once Carrier has been unloaded, raise Ramp and lock back into place. See Figure 7.

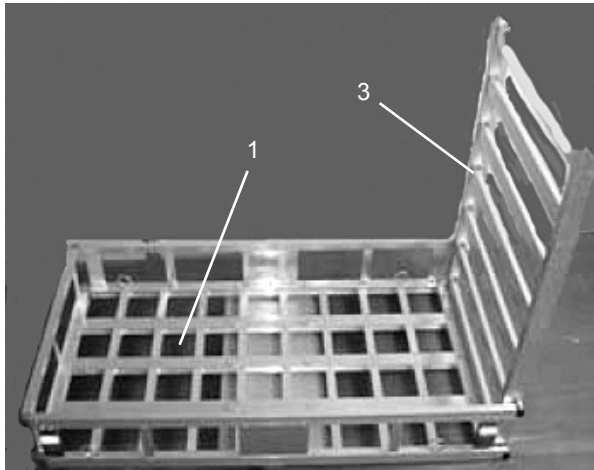

Figure 7

Maintenance and Servicing



Procedures not specifically explained in this manual must be performed only by a qualified technician.

⚠ WARNING

TO PREVENT SERIOUS INJURY:

Remove load from the Carrier before performing any maintenance or service.

Do not use damaged equipment. If the Carrier is damaged have the problem corrected before further use.

Cleaning, Maintenance, and Lubrication

- BEFORE EACH USE**, inspect the general condition of the Carrier. Check for:
 - loose hardware,
 - misalignment or binding of parts,
 - cracked, bent, or broken parts, and
 - any other condition that may affect its safe operation.
- Clean the Carrier after each use. Make sure dirt, oil, grease, and debris are not on the Carrier.

PLEASE READ THE FOLLOWING CAREFULLY

THE MANUFACTURER AND/OR DISTRIBUTOR HAS PROVIDED THE PARTS LIST IN THIS DOCUMENT AS A REFERENCE TOOL ONLY. NEITHER THE MANUFACTURER OR DISTRIBUTOR MAKES ANY REPRESENTATION OR WARRANTY OF ANY KIND TO THE BUYER THAT HE OR SHE IS QUALIFIED TO MAKE ANY REPAIRS TO THE PRODUCT, OR THAT HE OR SHE IS QUALIFIED TO REPLACE ANY PARTS OF THE PRODUCT. IN FACT, THE MANUFACTURER AND/OR DISTRIBUTOR EXPRESSLY STATES THAT ALL REPAIRS AND PARTS REPLACEMENTS SHOULD BE UNDERTAKEN BY CERTIFIED AND LICENSED TECHNICIANS, AND NOT BY THE BUYER. THE BUYER ASSUMES ALL RISK AND LIABILITY ARISING OUT OF HIS OR HER REPAIRS TO THE ORIGINAL PRODUCT OR REPLACEMENT PARTS THERETO, OR ARISING OUT OF HIS OR HER INSTALLATION OF REPLACEMENT PARTS THERETO.

Parts List and Assembly Diagram

Part	Description	Qty
1	Bed	1
2	U-Brace	1
3	Ramp	1
4	Pin	2
5	Medium Support	4
6	Support With Reflector	2
7	Small Support	6
8	Large Support	2
9	Hitch Bar	1
10	Hitch Pin	1
11	Hitch Lock Pin	3
12	Small Bolt (M5x12)	46

Part	Description	Qty
13	Lock Nut (M5)	46
14	Medium Bolt (M6x45)	10
15	Washer (ø6)	20
16	Lock Nut (M6)	10
17	Large Bolt (M8 x 30)	2
18	Lock Nut (M8)	2
19	Tie Down Hook	4
20	Washer (ø6)	4
21	Nut (M6)	4
22	Lock Pin	2
23	Large Washer	6

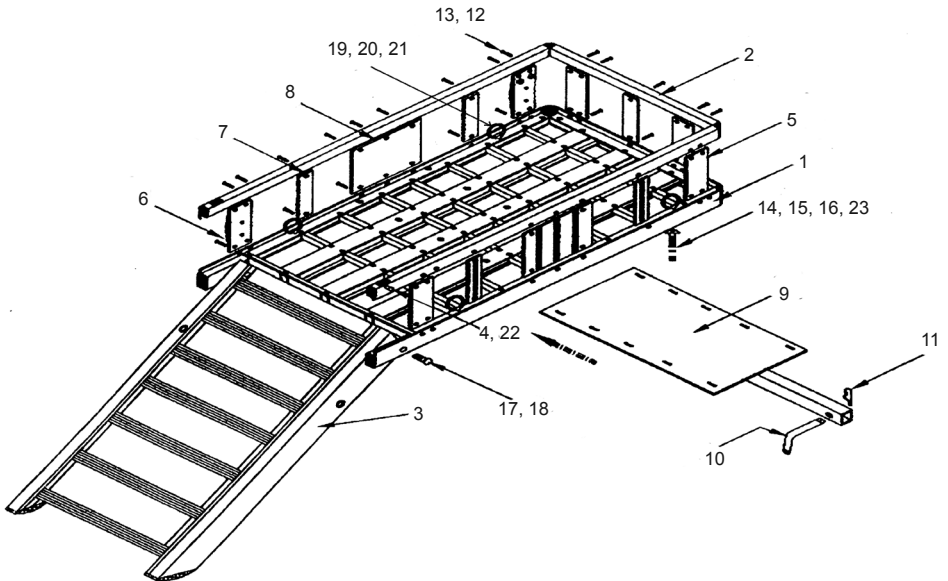

Record Serial Number Here:

Note: If product has no serial number, record month and year of purchase instead.

Note: Some parts are listed for illustration purposes only, and are not available individually as replacement parts.

Limited 90 Day Warranty

Harbor Freight Tools Co. makes every effort to assure that its products meet high quality and durability standards, and warrants to the original purchaser that this product is free from defects in materials and workmanship for the period of 90 days from the date of purchase. This warranty does not apply to damage due directly or indirectly, to misuse, abuse, negligence or accidents, repairs or alterations outside our facilities, criminal activity, improper installation, normal wear and tear, or to lack of maintenance. We shall in no event be liable for death, injuries to persons or property, or for incidental, contingent, special or consequential damages arising from the use of our product. Some states do not allow the exclusion or limitation of incidental or consequential damages, so the above limitation of exclusion may not apply to you. THIS WARRANTY IS EXPRESSLY IN LIEU OF ALL OTHER WARRANTIES, EXPRESS OR IMPLIED, INCLUDING THE WARRANTIES OF MERCHANTABILITY AND FITNESS.

To take advantage of this warranty, the product or part must be returned to us with transportation charges prepaid. Proof of purchase date and an explanation of the complaint must accompany the merchandise. If our inspection verifies the defect, we will either repair or replace the product at our election or we may elect to refund the purchase price if we cannot readily and quickly provide you with a replacement. We will return repaired products at our expense, but if we determine there is no defect, or that the defect resulted from causes not within the scope of our warranty, then you must bear the cost of returning the product.

This warranty gives you specific legal rights and you may also have other rights which vary from state to state.

