

Owner's Manual & Safety Instructions

Save This Manual Keep this manual for the safety warnings and precautions, assembly, operating, inspection, maintenance and cleaning procedures. Write the product's serial number in the back of the manual near the assembly diagram (or month and year of purchase if product has no number). Keep this manual and the receipt in a safe and dry place for future reference.

HaulMaster®

INDUSTRIAL POLYPROPYLENE SERVICE CART



Visit our website at: <http://www.harborfreight.com>
Email our technical support at: tech@harborfreight.com

REV 12c

ITEMS 69443 69444

When unpacking, make sure that the product is intact and undamaged. If any parts are missing or broken, please call 1-800-444-3353 as soon as possible.

Copyright© 2012 by Harbor Freight Tools®. All rights reserved.
No portion of this manual or any artwork contained herein may be reproduced in any shape or form without the express written consent of Harbor Freight Tools. Diagrams within this manual may not be drawn proportionally. Due to continuing improvements, actual product may differ slightly from the product described herein. Tools required for assembly and service may not be included.

⚠WARNING

**Read this material before using this product.
Failure to do so can result in serious injury.
SAVE THIS MANUAL.**

Specifications

Model	69443	69444
Maximum Capacity	500 lb. evenly distributed	
Tray Size	36" L x 16" W x 3" Deep	30" L x 24" W x 3" Deep

Important Safety Information

Assembly Precautions

1. Assemble only according to these instructions. Improper assembly can create hazards.
2. Wear ANSI-approved safety goggles and heavy-duty work gloves during assembly.
3. Keep assembly area clean and well lit.
4. Keep bystanders out of the area during assembly.
5. Do not assemble when tired or when under the influence of drugs or medication.
6. Weight capacity and other product capabilities apply to properly and completely assembled product only.

Use Precautions











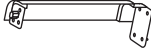

1. This product is not a toy. Do not allow children to play with or near this item.
2. Use as intended only.
3. Inspect before every use; do not use if parts are loose or damaged.
4. Do not exceed listed weight capacity, evenly distributed.
Be aware of dynamic loading!
Sudden load movement may briefly create excess load causing product failure.
5. Use only on flat, level, hard surface able to properly support cart and load.
6. Maintain product labels and nameplates. These carry important safety information. If unreadable or missing, contact Harbor Freight Tools for a replacement.

Assembly Instructions

Note: Use a rubber mallet to ensure snug connection of all nonmetal parts.

1. Place the bases of the four Posts (2,3) into the corners of a Tray (1). The flange on each Post will only fit into certain corners.
2. Insert Carriage Bolts (10) down through the holes in the bases of the Posts (2,3).
3. Attach Casters (6,7) to Carriage Bolts (10) using Split Washers (11) and Nuts (12). For best operation, the two Straight Casters (6) go on the same end of the cart, and the two Swivel Casters (7) go on the other end.
4. Place the other Tray (1) upside down on the work surface. Turn the Handle (8) upside down with the cup holder toward the Tray and the hand holes on the outside.
5. Place the Tray with the Handle firmly on top of the Posts (2,3). Position the Handle above either the swivel or fixed casters, depending on operating preference.
6. Place a Post Cap (4,5) on top of each corner of the Tray (1).
7. Use three Screws (9) through each Post (2,3) from underneath to secure them.

Parts List and Diagram

Part	Description	Illustration	Qty
1	Tray		2
2	RH Post		2
3	LH Post		2
4	RH Post Cap		2
5	LH Post Cap		2
6	Straight Caster		2
7	Swivel Caster		2
8	Handle		1
9	Screw		12
10	Carriage Bolt		16
11	Split Washer		16
12	Nut		16

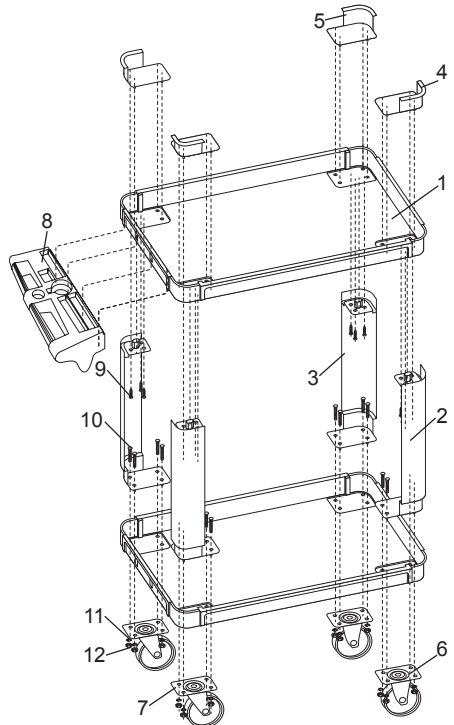

REV 12c

Note: Some parts are listed and shown for illustration purposes only, and are not available individually as replacement parts.

PLEASE READ THE FOLLOWING CAREFULLY

THE MANUFACTURER AND/OR DISTRIBUTOR HAS PROVIDED THE PARTS LIST AND ASSEMBLY DIAGRAM IN THIS DOCUMENT AS A REFERENCE TOOL ONLY. NEITHER THE MANUFACTURER OR DISTRIBUTOR MAKES ANY REPRESENTATION OR WARRANTY OF ANY KIND TO THE BUYER THAT HE OR SHE IS QUALIFIED TO MAKE ANY REPAIRS TO THE PRODUCT, OR THAT HE OR SHE IS QUALIFIED TO REPLACE ANY PARTS OF THE PRODUCT. IN FACT, THE MANUFACTURER AND/OR DISTRIBUTOR EXPRESSLY STATES THAT ALL REPAIRS AND PARTS REPLACEMENTS SHOULD BE UNDERTAKEN BY CERTIFIED AND LICENSED TECHNICIANS, AND NOT BY THE BUYER. THE BUYER ASSUMES ALL RISK AND LIABILITY ARISING OUT OF HIS OR HER REPAIRS TO THE ORIGINAL PRODUCT OR REPLACEMENT PARTS THERETO, OR ARISING OUT OF HIS OR HER INSTALLATION OF REPLACEMENT PARTS THERETO.

Limited 90 Day Warranty

Harbor Freight Tools Co. makes every effort to assure that its products meet high quality and durability standards, and warrants to the original purchaser that this product is free from defects in materials and workmanship for the period of 90 days from the date of purchase. This warranty does not apply to damage due directly or indirectly, to misuse, abuse, negligence or accidents, repairs or alterations outside our facilities, criminal activity, improper installation, normal wear and tear, or to lack of maintenance. We shall in no event be liable for death, injuries to persons or property, or for incidental, contingent, special or consequential damages arising from the use of our product. Some states do not allow the exclusion or limitation of incidental or consequential damages, so the above limitation of exclusion may not apply to you. THIS WARRANTY IS EXPRESSLY IN LIEU OF ALL OTHER WARRANTIES, EXPRESS OR IMPLIED, INCLUDING THE WARRANTIES OF MERCHANTABILITY AND FITNESS.

To take advantage of this warranty, the product or part must be returned to us with transportation charges prepaid. Proof of purchase date and an explanation of the complaint must accompany the merchandise. If our inspection verifies the defect, we will either repair or replace the product at our election or we may elect to refund the purchase price if we cannot readily and quickly provide you with a replacement. We will return repaired products at our expense, but if we determine there is no defect, or that the defect resulted from causes not within the scope of our warranty, then you must bear the cost of returning the product.

This warranty gives you specific legal rights and you may also have other rights which vary from state to state.

