

Owner's Manual & Safety Instructions

Save This Manual Keep this manual for the safety warnings and precautions, assembly, operating, inspection, maintenance and cleaning procedures. Write the product's serial number in the back of the manual near the assembly diagram (or month and year of purchase if product has no number). Keep this manual and the receipt in a safe and dry place for future reference.

17h

CENTTECH®

69465

INFRARED THERMOMETER with Laser Targeting



Visit our website at: <http://www.harborfreight.com>
Email our technical support at: productsupport@harborfreight.com

When unpacking, make sure that the product is intact and undamaged. If any parts are missing or broken, please call 1-888-866-5797 as soon as possible.





Copyright© 2012 by Harbor Freight Tools®. All rights reserved.

No portion of this manual or any artwork contained herein may be reproduced in any shape or form without the express written consent of Harbor Freight Tools. Diagrams within this manual may not be drawn proportionally. Due to continuing improvements, actual product may differ slightly from the product described herein. Tools required for assembly and service may not be included.

⚠WARNING

**Read this material before using this product.
Failure to do so can result in serious injury.
SAVE THIS MANUAL.**

WARNING SYMBOLS AND DEFINITIONS

	This is the safety alert symbol. It is used to alert you to potential personal injury hazards. Obey all safety messages that follow this symbol to avoid possible injury or death.
 DANGER	Indicates a hazardous situation which, if not avoided, will result in death or serious injury.
 WARNING	Indicates a hazardous situation which, if not avoided, could result in death or serious injury.
 CAUTION	Indicates a hazardous situation which, if not avoided, could result in minor or moderate injury.
NOTICE CAUTION	Addresses practices not related to personal injury.

IMPORTANT SAFETY INFORMATION

 **WARNING** Read all safety warnings and instructions. *Failure to follow the warnings and instructions may result in serious injury.*

1. **Do not use for medical purposes.**
2. **Do not open the housing other than battery compartment.**
3. **Avoid direct Eye exposure.**
4. **Do not expose the tool to rain or wet conditions.**
5. **Stay alert, watch what you are doing and use common sense when operating the tool. Do not use while you are tired or under the influence of drugs, alcohol or medication. A moment of inattention may result in serious personal injury.**
6. **Do not use the tool if the Trigger does not turn it on and off. Any tool that cannot be controlled with the Trigger is dangerous and must be repaired.**
7. **Disconnect the battery before making any adjustments, changing accessories, or storing the tool. Such preventive safety measures reduce the risk of activating the Laser accidentally.**
8. **Maintain the tool. Check for misalignment or binding of parts, breakage of parts and any other condition that may affect the tool's operation. If damaged, have the tool repaired before use. Many accidents are caused by poorly maintained tools.**
9. **Use the tool in accordance with these instructions, taking into account the working conditions and the work to be performed. Use of the tool for operations different from those intended could result in a hazardous situation.**
10. **Have your tool serviced by a qualified repair person using only identical replacement parts. This will ensure that the safety of the tool is maintained.**
11. Do not mix old and new batteries. Do not mix alkaline, standard (carbon-zinc), or rechargeable (nickel-cadmium) batteries. Position batteries in proper polarity. Do not use swollen or leaking batteries.
12. Maintain labels and nameplates on the tool. These carry important safety information. If unreadable or missing, contact Harbor Freight Tools for a replacement.

13. This product is not a toy. Keep it out of reach of children.
14. The warnings, precautions, and instructions discussed in this instruction manual cannot cover all possible conditions and situations that may occur. It must be understood by the operator that common sense and caution are factors which cannot be built into this product, but must be supplied by the operator.



SAVE THESE INSTRUCTIONS.

CEN-TECH®

Specifications

Measurement Range	-36°F to 968°F (-38°C to 520°C)
Accuracy	± 2% above 32°F ± 4.5% below 31°F
Response Time	1 Sec
Spot Size Ratio	8:1 (Distance : Spot size)
Needed Batteries	Two AAA (not included)

CAUTION



LASER LIGHT
AVOID DIRECT EYE EXPOSURE

Max. Output: <1 mW,
Wavelength: 635-660 nm
CLASS II LASER PRODUCT

This product complies with
21 CFR 1040.10 and 1040.11
Distributed by Harbor Freight Tools
3491 Mission Oaks Blvd.
Camarillo, CA 93011
69465
17h

⚠ WARNING
To prevent serious injury,
do not use for medical purposes.
Manufacture Date:

Setup - Before Use:



Read the **ENTIRE IMPORTANT SAFETY INFORMATION** section at the beginning of this manual including all text under subheadings therein before set up or use of this product.

Installing the Battery

Remove the battery cover and insert two AAA batteries into the unit, following indicated polarity. Replace the battery cover.

Functions



Operating Instructions



Read the **ENTIRE IMPORTANT SAFETY INFORMATION** section at the beginning of this manual including all text under subheadings therein before set up or use of this product.

General Operating Instructions

Note: Do not expose this product to strong electromagnetic fields, such as those generated by an arc welder, induction heater, etc.

Note: When moving the Thermometer to an area with significantly different ambient temperature, allow the unit to adjust to the new ambient temperature for 30 minutes before use.

1. Squeeze the Trigger to activate the Laser and temperature reading.
2. Push the °F/°C button to toggle between Fahrenheit to Celsius, and to recover the last reading when in OFF mode.
3. Squeeze the Trigger and move the laser to see a constant temperature reading and max reading.
4. Release the Trigger to display the most recent temperature reading, or to allow 15 seconds for auto shut off.
5. Non-reflective surfaces will yield a more accurate reading than reflective surfaces. Duct tape (sold separately) can be applied to reflective surfaces in order to get a better measurement. Allow sufficient time for the tape to match the temperature of the surface it is applied to before trying to get a reading.

6. The object being tested should be larger than the size calculated by the Field of View diagram, below.

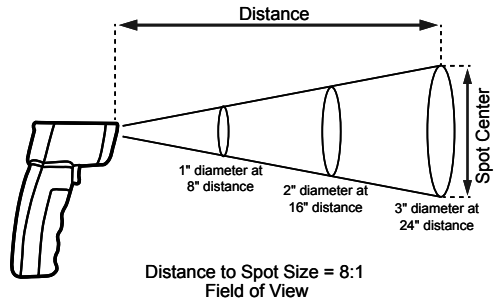

7. When finished, release the Trigger. The last temperature will display for 15 seconds, then the unit will shut off.
8. Clean the lens with dry compressed air and wipe the rest of the unit down with a soft, damp cloth, then store the product indoors out of children's reach.
9. To prevent accidents, turn off the tool and disconnect its power supply after use. Clean, then store the tool indoors out of children's reach.

Maintenance and Servicing



Procedures not specifically explained in this manual must be performed only by a qualified technician.

! WARNING

TO PREVENT SERIOUS INJURY FROM ACCIDENTAL OPERATION:
Release the Trigger and remove the batteries from the Laser Thermometer before performing any inspection, maintenance, or cleaning procedures.

TO PREVENT SERIOUS INJURY FROM TOOL FAILURE:
Do not use damaged equipment. If damage is noted, have the problem corrected before further use.

Cleaning, Maintenance, and Lubrication

1. **BEFORE EACH USE**, inspect the general condition of the tool. Check for:
 - loose hardware,
 - misalignment or binding of parts,
 - cracked or broken parts,
 - damaged electrical wiring, and
 - any other condition that may affect its safe operation.
2. **AFTER USE**, wipe external surfaces of the tool with clean cloth.

PLEASE READ THE FOLLOWING CAREFULLY

THE MANUFACTURER AND/OR DISTRIBUTOR HAS PROVIDED THE PARTS LIST AND ASSEMBLY DIAGRAM IN THIS MANUAL AS A REFERENCE TOOL ONLY. NEITHER THE MANUFACTURER OR DISTRIBUTOR MAKES ANY REPRESENTATION OR WARRANTY OF ANY KIND TO THE BUYER THAT HE OR SHE IS QUALIFIED TO MAKE ANY REPAIRS TO THE PRODUCT, OR THAT HE OR SHE IS QUALIFIED TO REPLACE ANY PARTS OF THE PRODUCT. IN FACT, THE MANUFACTURER AND/OR DISTRIBUTOR EXPRESSLY STATES THAT ALL REPAIRS AND PARTS REPLACEMENTS SHOULD BE UNDERTAKEN BY CERTIFIED AND LICENSED TECHNICIANS, AND NOT BY THE BUYER. THE BUYER ASSUMES ALL RISK AND LIABILITY ARISING OUT OF HIS OR HER REPAIRS TO THE ORIGINAL PRODUCT OR REPLACEMENT PARTS THERETO, OR ARISING OUT OF HIS OR HER INSTALLATION OF REPLACEMENT PARTS THERETO.

Parts List and Diagram

Part	Description
1	Front Cover
2	Rear Cover
3	Battery Cover
4	Trigger
5	°F/°C Button
6	LCD
7	Back Light
8	Layered Block
9	PCB
10	Switch

Part	Description
11	Front Mass
12	Lens
13	RMASS
14	TPI RMASS
15	Thermopile
16	Laser Holder -B
17	Laser Module
18	Negative Plate
19	Positive Plate
20	P-N Plate

Part	Description
21	Tapping Screw (M 1.7*5L)
22	Machine Screw (M 2* 4L)
23	Tapping Screw (M 1.7*4L)
24	Tapping Screw (M 2.3*8L)
25	Battery (not included)
26	Pad

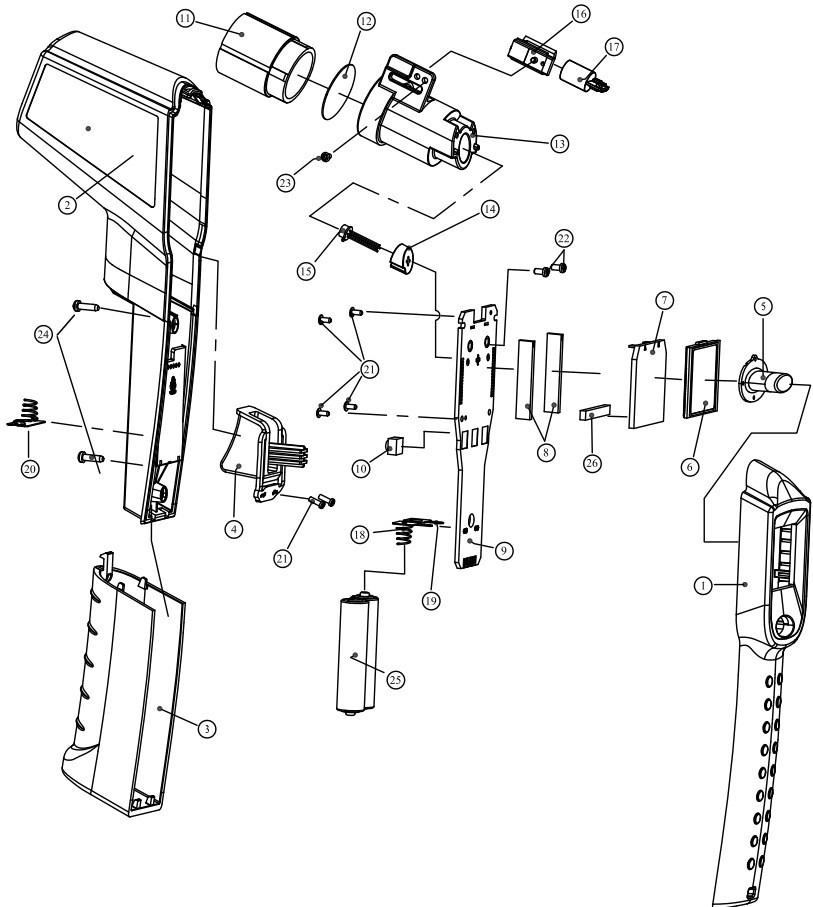

SAFETY

SETUP

OPERATION

MAINTENANCE

Limited 90 Day Warranty

Harbor Freight Tools Co. makes every effort to assure that its products meet high quality and durability standards, and warrants to the original purchaser that this product is free from defects in materials and workmanship for the period of 90 days from the date of purchase. This warranty does not apply to damage due directly or indirectly, to misuse, abuse, negligence or accidents, repairs or alterations outside our facilities, criminal activity, improper installation, normal wear and tear, or to lack of maintenance. We shall in no event be liable for death, injuries to persons or property, or for incidental, contingent, special or consequential damages arising from the use of our product. Some states do not allow the exclusion or limitation of incidental or consequential damages, so the above limitation of exclusion may not apply to you. THIS WARRANTY IS EXPRESSLY IN LIEU OF ALL OTHER WARRANTIES, EXPRESS OR IMPLIED, INCLUDING THE WARRANTIES OF MERCHANTABILITY AND FITNESS.

To take advantage of this warranty, the product or part must be returned to us with transportation charges prepaid. Proof of purchase date and an explanation of the complaint must accompany the merchandise. If our inspection verifies the defect, we will either repair or replace the product at our election or we may elect to refund the purchase price if we cannot readily and quickly provide you with a replacement. We will return repaired products at our expense, but if we determine there is no defect, or that the defect resulted from causes not within the scope of our warranty, then you must bear the cost of returning the product.

This warranty gives you specific legal rights and you may also have other rights which vary from state to state.

Record Product's Serial Number Here: _____

Note: If product has no serial number, record month and year of purchase instead.

Note: Some parts are listed and shown for illustration purposes only, and are not available individually as replacement parts.

CENTTECH®

3491 Mission Oaks Blvd. • PO Box 6009 • Camarillo, CA 93011 • 1-888-866-5797