

Owner's Manual & Safety Instructions

Save This Manual Keep this manual for the safety warnings and precautions, assembly, operating, inspection, maintenance and cleaning procedures. Write the product's serial number in the back of the manual near the assembly diagram (or month and year of purchase if product has no number). Keep this manual and the receipt in a safe and dry place for future reference.

23e

4000 LB CAPACITY

HaulMaster®

CABLE

WINCH PULLER

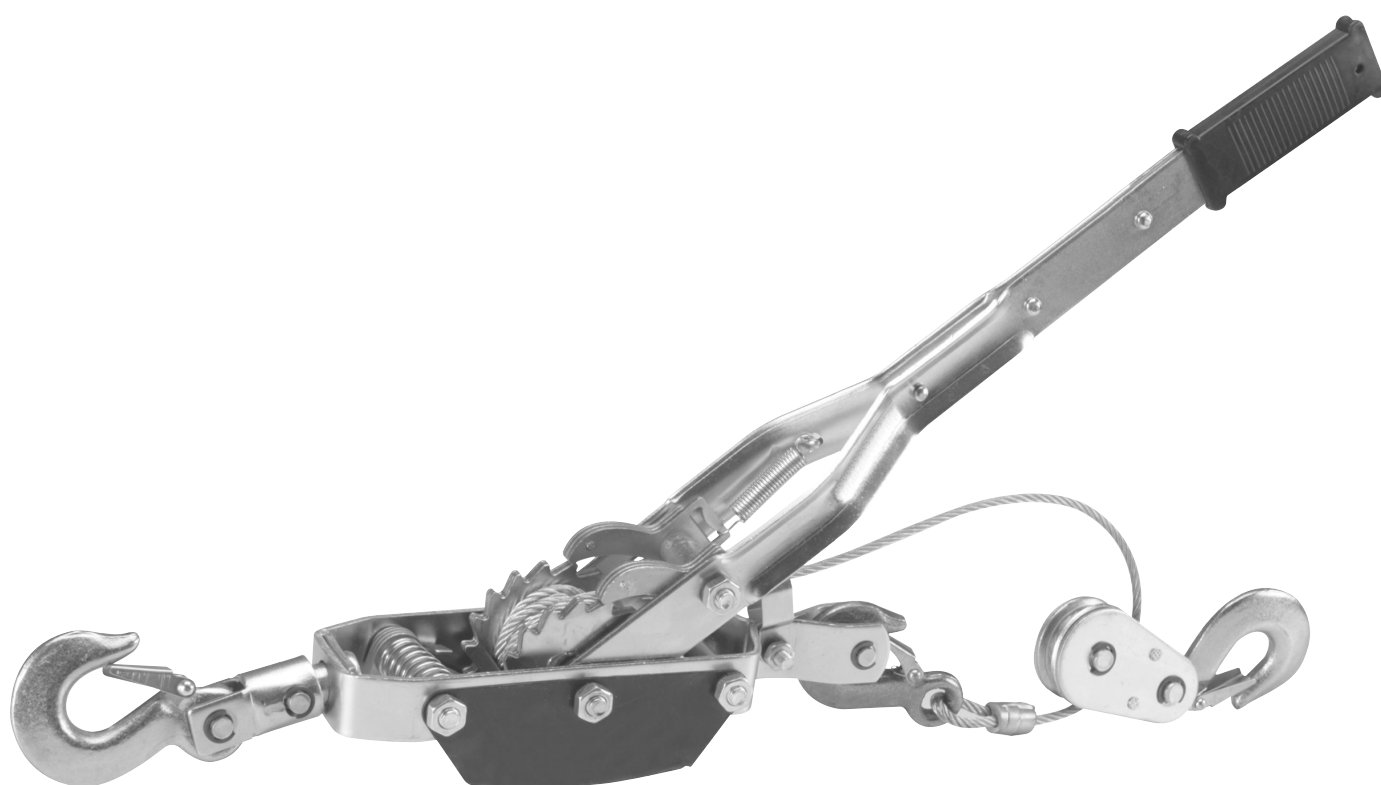

Visit our website at: <http://www.harborfreight.com>
Email our technical support at: productsupport@harborfreight.com

69855

When unpacking, make sure that the product is intact and undamaged. If any parts are missing or broken, please call 1-888-866-5797 as soon as possible.

Copyright© 2020 by Harbor Freight Tools®. All rights reserved.
No portion of this manual or any artwork contained herein may be reproduced in any shape or form without the express written consent of Harbor Freight Tools. Diagrams within this manual may not be drawn proportionally. Due to continuing improvements, actual product may differ slightly from the product described herein.
Tools required for assembly and service may not be included.

⚠ WARNING

Read this material before using this product.
Failure to do so can result in serious injury.
SAVE THIS MANUAL.

Table of Contents

Safety	3	Inspection	8
Specifications	4	Parts List and Diagram	11
Setup	4	Warranty	12
Operation.....	5		



SAFETY

SETUP

OPERATION

INSPECTION

WARNING SYMBOLS AND DEFINITIONS	
	This is the safety alert symbol. It is used to alert you to potential personal injury hazards. Obey all safety messages that follow this symbol to avoid possible injury or death.
	Indicates a hazardous situation which, if not avoided, will result in death or serious injury.
	Indicates a hazardous situation which, if not avoided, could result in death or serious injury.
	Indicates a hazardous situation which, if not avoided, could result in minor or moderate injury.
	Addresses practices not related to personal injury.

IMPORTANT SAFETY INFORMATION

WARNING

TO PREVENT SERIOUS INJURY AND DEATH:

Basic Safety Information

1. **Do not pull more than rated load. Be aware of dynamic loading!** Sudden load movement may briefly create excess load causing product failure.
2. **Do not operate while puller restricted from forming a straight line with loading direction.**
3. **Do not operate puller with twisted, kinked, or damaged wire rope.**
Inspect wire rope carefully before every use.
4. **Do not operate a damaged or malfunctioning puller.** Inspect puller carefully and test operation before every use.
5. **Do not use for vertical lifting. Do not lift people or lift loads over people.**
Falling loads can injure or kill people.
6. **Do not operate puller with a lever extension.**
7. **Do not operate with rope not centered in its groove.**
8. **Do not remove or cover warning labels and/or tags.** These carry important safety information. If unreadable or missing, contact Harbor Freight Tools for a replacement.
9. The warnings, precautions, and instructions discussed in this instruction manual cannot cover all possible conditions and situations that may occur. It must be understood by the operator that common sense and caution are factors which cannot be built into this product, but must be supplied by the operator.

Setup Specific Safety Information

1. The supporting structure the puller is mounted to must be designed to withstand the loads and forces imposed by the puller for the rated load.
2. Install in location that allows the operator to move and stay clear of the load.
3. Inspect the puller as explained in Frequent Inspection on page 8 after setup but before use.

Inspection, Testing, and Maintenance Specific Safety Information

1. Perform a "Frequent Inspection" at least monthly, see page 8.
2. Perform a "Periodic (Thorough) Inspection" at least yearly, see page 9.
3. More frequent inspections are needed for pullers that are used heavily.
4. Raise test loads only to the minimum extent needed and stay well clear of load at all times during testing.

Operation Specific Safety Information

1. Wear ANSI-approved safety goggles, ANSI-approved hard hat, and steel-toed work boots during setup and use.
2. This product is not a toy. Do not allow children to play with or near this item.
3. Use as intended only.
 - Do not use to handle molten material.
 - Do not use for aircraft purposes.
 - Do not use to link towed vehicles.
4. Keep hands clear of moving parts.



SAVE THESE INSTRUCTIONS.

Specifications

Rated Capacity	4,000 lb. double line 2,000 lb. single line
Maximum Extension	6' double line 10' single line

Setup Instructions



Read the **ENTIRE IMPORTANT SAFETY INFORMATION** section at the beginning of this manual including all text under subheadings therein before set up or use of this product.

Note: For additional information regarding the parts listed in the following pages, refer to *Parts List and Diagram* on page 11.

1. The supporting structure the puller is mounted to (including trolley, monorail, or crane) must be designed to withstand the loads and forces imposed by the puller for the rated load.
2. Properly seat the anchor hook on the supporting structure at its intended load bearing point (see the left side diagram of Figure A). Do not allow the hook hitch to support any part of the load. Do not apply the load to the point of the hook (shown in Figure A on the right side diagram).

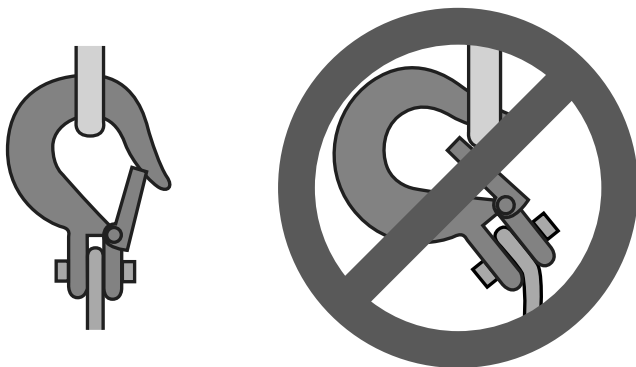

Figure A: Correct and incorrect anchor hook attachment

Operation Instructions



Read the **ENTIRE IMPORTANT SAFETY INFORMATION** section at the beginning of this manual including all text under subheadings therein before set up or use of this product.

WARNING

TO PREVENT SERIOUS INJURY: Operation of a puller involves more than pulling the lever. The use of pullers is subject to certain hazards that cannot be met by mechanical means, but only by the exercise of intelligence, care, common sense, and experience in anticipating the motions that will occur as a result of operating the controls.

Do not use this tool for vertical lifting.

Before Operating Puller

1. Familiarize yourself with all operating controls of the puller and with the operation(s) to be performed. Instructions include, the warnings on the puller, and the safety and operating instructions portion of this manual.
2. **WARNING! TO PREVENT SERIOUS INJURY FROM PULLER FAILURE:**
Do not use damaged equipment.
If adjustments or repairs are necessary, or any defects are known, have the problem corrected before further use.
3. Do not operate a puller with an out-of-order sign.
4. Only a qualified technician should perform maintenance to the puller.
5. Do not use the wire rope as a ground for welding. Do not touch a welding electrode to the wire rope.
6. Designate a work area that is clean and well-lit. The work area must not allow access by children or pets to prevent distraction and injury.
7. There must not be objects, such as utility lines, nearby that will present a hazard while working.
8. Inspect the puller as explained in Frequent Inspection on page 8 after setup but before use.

Operating Controls

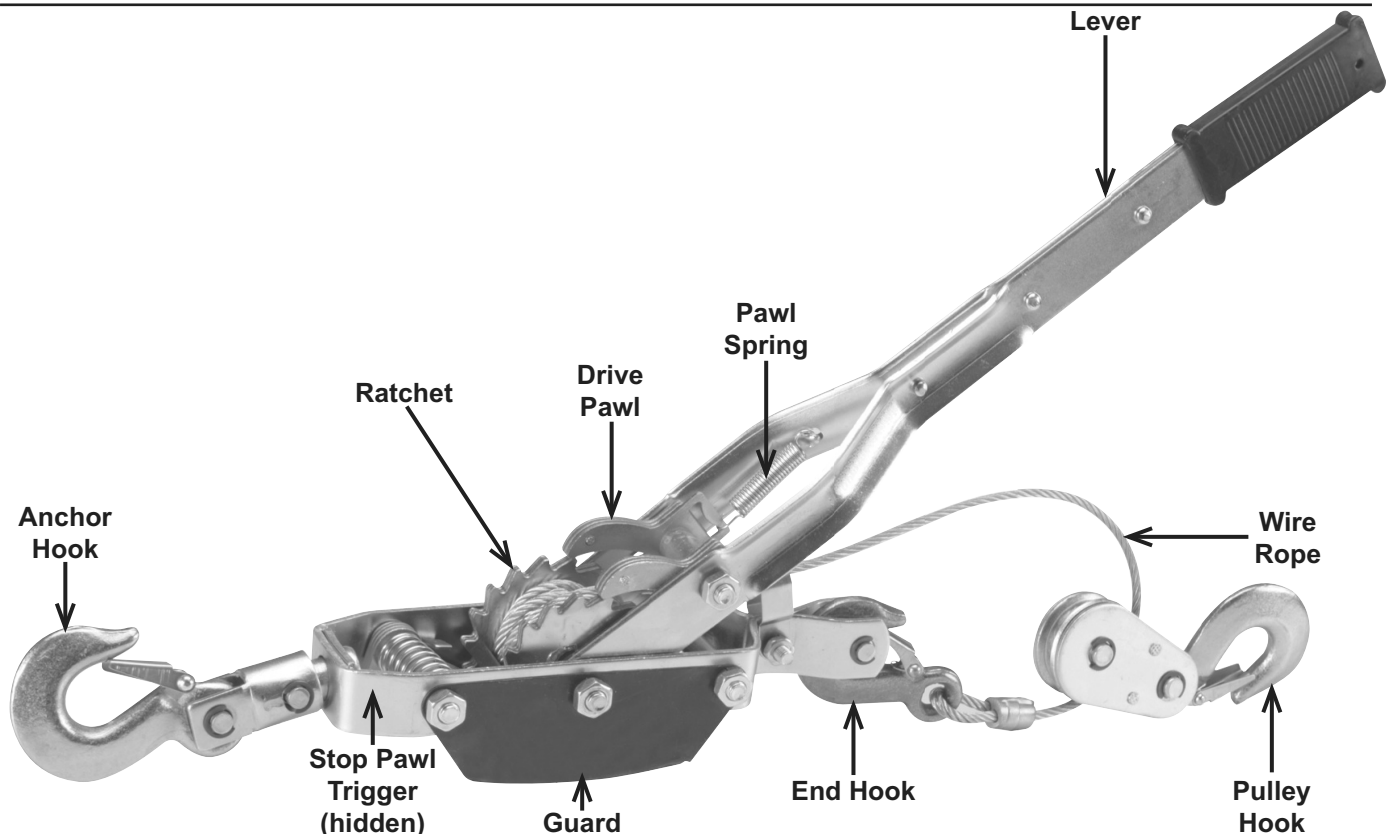

Figure B

Applying the Load

1. **The puller is designed for single or double line pulls.**
 - a. A single line pull can reach twice as far and retract twice as fast, but it has half the weight capacity.
 - b. To do a single line pull, unhook the wire rope end hook and use it as the load hook.
 - c. For double line pulls, attach the end hook to the puller's frame as shown in Figure B, and use the pulley hook as the load hook.
2. Swing the Handle away from the Anchor Hook to expose the Drive Pawl.

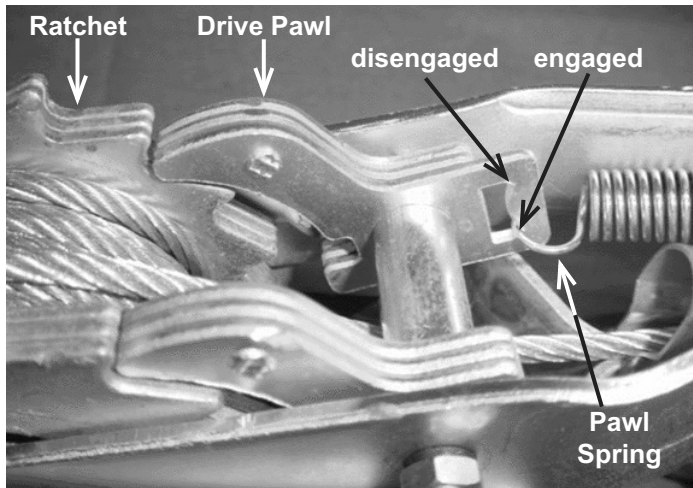

Figure C: Drive Pawl Operation

3. Slide the Pawl Spring up to the disengaged position. The Drive Pawl will be held clear of the Ratchet.

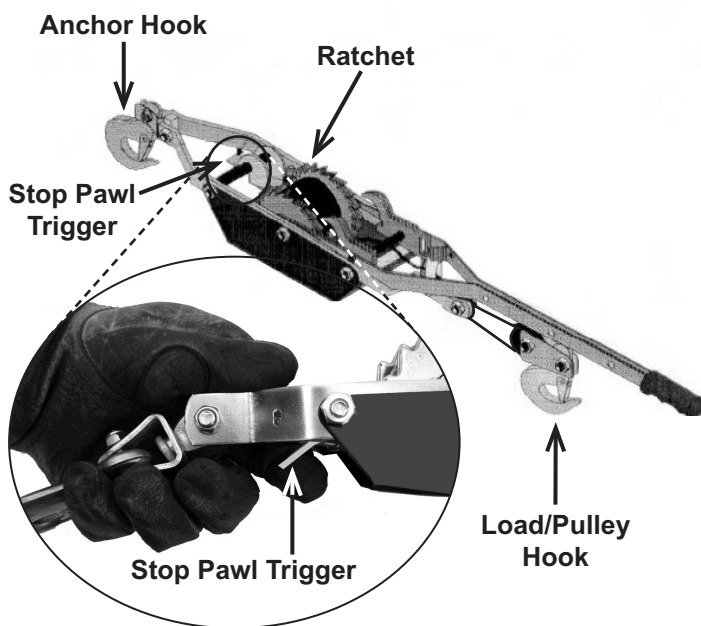

Figure E: Releasing the Stop Pawl

4. Squeeze the Stop Pawl Trigger as shown above.

5. Pull the wire rope out to reach the load.
6. Release the Stop Pawl Trigger.
7. Do not wrap the puller wire rope around the load.
8. Attach the load to the load hook securely by properly rated, suitable means, such as chains, shackles, hooks, lifting slings, etc. Load must be attached to prevent accidental disconnection.

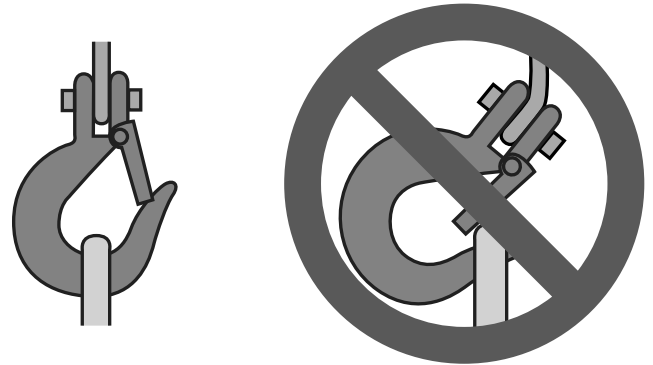

Figure F: Correct and incorrect load hook attachment

9. Properly seat the sling or other device in the base (bowl or saddle) of the hook (see the left side diagram on Figure F). Do not allow the hook hitch to support any part of the load.
10. Do not apply the load to the point of the hook (shown in Figure F on the right side diagram).
11. Before moving the load, make sure wire rope is not kinked or twisted or that multiple part wire ropes are not twisted around each other.
12. Do not operate the puller unless wire rope is seated properly on the drum, pulleys, or sprockets.
13. Do not pick up a load in excess of the rated load appearing on the puller or load block, except during properly authorized tests. Do not use a puller overload limiting device to measure the maximum load to be pulled.
14. Give specific attention to load balancing and hitching or slinging to prevent load slipping.

Moving the Load

1. Slide the Pawl Spring down to the engaged position, as shown in Figure C. The Drive Pawl will be pressed against the Ratchet.
2. Do not engage in any activity which will divert the operator's attention while operating the puller.
3. Respond to signals from a designated person only. However, always obey a stop signal, no matter who gives it.
4. Do not move a load with the puller until the operator and all other personnel are clear of the load.
5. Make sure the load and puller will clear all obstacles before moving or rotating the load.
6. Do not move a load more than a few inches until it is well balanced in the sling or pulling device.
7. Each time a load approaching rated capacity is handled, check puller brake action by pulling the load just clear of supports and continuing only after verifying that the brake system is operating properly.
8. **WARNING! Do not carry any load over any person.**
9. **WARNING! TO PREVENT SERIOUS INJURY: Do not carry personnel on the hook or the load.**
10. Pull the Handle toward the Anchor side of the Puller. This will pull the Load.
11. Swing the Handle back and forth until the load has been pulled to the desired position.

Parking the Load

1. Do not leave a supported load unattended unless specific precautions have been instituted and are in place.
2. Exercise care when removing a sling from under a landed and blocked load.
3. Secure the load so it will not move before releasing the tension on the wire rope.
4. To release the wire rope tension:
 - a. Swing the Handle away from the Anchor Hook to expose the Drive Pawl.
 - b. Slide the Pawl Spring up to the disengaged position. The Drive Pawl will be held clear of the Ratchet.
 - c. Swing the handle to the Anchor Hook side and force the spring loaded STOP PAWL pin down, then slowly raise the handle. This action will allow the wire rope drum to back off by one cam step.
 - d. Repeat this action, as needed, until the tension on the wire rope eases.
 - e. Pull on the STOP PAWL TRIGGER to release it from the cam and gently pull back on the tool to get wire rope slack and free it from the load.
5. To prevent entangling of the wire rope onto the drum, with the Load Hook still attached to the load, push the spring into its "Down" position. Hold the Anchor hook in one hand. While gently pulling against the load, swing the Handle back and forth to rewind the wire rope.

CAUTION! Do not rewind the wire rope to its end.

Inspection, Testing, and Maintenance



Procedures not specifically explained in this manual must be performed only by a qualified technician.

WARNING

TO PREVENT SERIOUS INJURY:

Remove any load before performing any inspection, maintenance, or cleaning procedures.

TO PREVENT SERIOUS INJURY FROM TOOL FAILURE:

Do not use damaged equipment. If abnormal noise or vibration occurs, have the problem corrected before further use.

Frequent Inspection

Perform the procedures in this section **BEFORE INITIAL USE** and **AT LEAST MONTHLY**. Inspection is needed more often for heavily used pullers.

1. Check operating mechanisms for proper operation, proper adjustment, and unusual sounds such as, but not limited to, binding noise of the wire rope and bearing squeal.
2. Frequent Braking System Inspection
 - a. The braking system must automatically stop and hold up to the rated load if the lever is released.
3. Frequent Hook Inspection

Check hooks for the following problems:

 - a. distortion, such as bending, twisting, or increased throat opening;
 - b. wear;
 - c. cracks, nicks, or gouges;
 - d. latch engagement (if equipped);
 - e. damaged or malfunctioning latch (if equipped);
 - f. hook attachment and securing means.

4. Frequent Puller Rope Inspection

All ropes should be visually inspected by the operator or other designated person at the start of each shift. These visual observations should be concerned with discovering gross damage, such as listed below, which may be an immediate hazard:

- a. distortion of the rope such as kinking, crushing, unstranding, birdcaging, main strand displacement, or core protrusion;
- b. general corrosion;
- c. broken or cut strands;
- d. number, distribution, and type of visible broken wires:
 - 1) in running ropes, 12 randomly distributed broken wires in one lay or four broken wires in one strand in one lay;
 - 2) one outer wire broken at the contact point with the core of the rope which has worked its way out of the rope structure and protrudes or loops out from the rope structure.

If such damage is discovered, either remove the rope from service or arrange for a qualified technician to give it a periodic (thorough) inspection.

5. Check wire rope reeving.
6. Check puller lever for bends, cracks, or other damage.
7. Check for damage to the support for the puller.

WARNING! TO PREVENT SERIOUS INJURY FROM PULLER FAILURE: Do not use damaged equipment. If any defect or damage is noted, have the problem corrected before further use.

Periodic (Thorough) Inspection

A qualified technician should perform the procedures in this section AT LEAST YEARLY. Inspection is needed more often for heavily used pullers.

Remove or open access covers to allow inspection of components.

1. First, follow all Frequent Inspection procedures. Additionally:
2. Check fasteners for evidence of loosening.
3. Check load blocks, suspension housings, levers, clevises, yokes, suspension bolts, shafts, gears, bearings, pins, rollers, and locking and clamping devices for evidence of wear, corrosion, cracks, and distortion.
4. Check hook retaining nuts or collars, and pins, welds, or rivets used to secure the retaining members for evidence of damage.
5. Check load sprockets, idler sprockets, drums, and pulleys for evidence of damage and wear.
6. Check the brake mechanism for evidence of worn, glazed, or oil contaminated friction disks; worn pawls, cams, or ratchets; and corroded, stretched, or broken pawl springs.
7. Check supporting structure or trolley, if used, for evidence of damage.
8. Check warning label for legibility and replacement.
9. Check end connections of wire ropes for evidence of wear, corrosion, cracks, damage, and distortion.

 WARNING! TO PREVENT SERIOUS INJURY FROM PULLER FAILURE: Do not use damaged equipment. If any defect or damage is noted, have the problem corrected before further use.

10. Periodic (Thorough) Puller Rope Inspection

Check entire length of rope puller rope as follows:

Inspect the individual outer wires in the strands of the rope. Keep a record of any deterioration resulting in appreciable loss of original strength, such as described below, and have a qualified technician determine whether further use of the rope would constitute a hazard:

- a. Check points listed in Frequent Puller Rope Inspection on page 8.
 - b. Check for reduction of rope diameter below nominal diameter due to loss of core support, internal or external corrosion, or wear of outside wires.
 - c. Check for severely corroded or broken wires at end connections.
 - d. Check for severely corroded, cracked, bent, worn, or improperly applied end connections.
 - e. Inspect with special care the following sections of rapid deterioration:
 - 1) sections in contact with saddles, equalizer pulleys, or other pulleys where rope travel is limited;
 - 2) sections of the rope at or near terminal ends where corroded or broken wires may protrude;
 - 3) sections subject to reverse bends;
 - 4) sections of rope which are normally hidden during visual inspection, such as parts passing over pulleys.
11. Check the puller and puller mounting for evidence of missing parts.

Storage Inspection

1. A puller that has been idle for a period of a month or more, but less than a year, must be inspected before being used according to the Frequent Inspection requirements.
2. A puller that has been idle for a period of a year or more, must be inspected according to the Periodic Inspection requirements and then tested according to the procedure in the Testing section below before being used.

Maintenance

1. Repair or replacement of puller components must be performed only by a qualified technician using only identical replacement parts with the same rating.
2. Operating mechanisms, pawls, and brakes may require adjustment.
3. Note the following regarding specific components:
 - a. Replace damaged or worn hooks. Do not repair them by welding or reshaping.
 - b. Replace excessively worn braking components such as friction disks, ratchets, pawls, and pawl springs.
 - c. Replace or repair all critical parts, including load suspension components, that are cracked, broken, bent, excessively worn, or missing.
 - d. Replace bent, cracked, or otherwise damaged levers.
 - e. Replace missing or illegible warning labels.
4. Do not repair load-sustaining members by welding. Replace them as needed.
5. Lubricate all moving parts regularly using grease.
6. After maintenance work is completed and before restoring the puller to normal operation:
 - a. reinstall guards;
 - b. reactivate safety devices;
 - c. remove replaced parts and loose material;
 - d. remove maintenance equipment.

Testing

1. Before use, test repaired pullers and pullers that have not been used for a year or more.
2. Check all functions of the puller, including retracting and extending, with the puller unloaded first. (This puller may require a small load or pull on the load hook to test lowering/extending.)
3. After testing in the unloaded state, attach a 200 lb. load and retest to check proper load control and to check brake operation.
4. Test in both single and double line setups.

PLEASE READ THE FOLLOWING CAREFULLY

THE MANUFACTURER AND/OR DISTRIBUTOR HAS PROVIDED THE PARTS LIST AND ASSEMBLY DIAGRAM IN THIS MANUAL AS A REFERENCE TOOL ONLY. NEITHER THE MANUFACTURER OR DISTRIBUTOR MAKES ANY REPRESENTATION OR WARRANTY OF ANY KIND TO THE BUYER THAT HE OR SHE IS QUALIFIED TO MAKE ANY REPAIRS TO THE PRODUCT, OR THAT HE OR SHE IS QUALIFIED TO REPLACE ANY PARTS OF THE PRODUCT. IN FACT, THE MANUFACTURER AND/OR DISTRIBUTOR EXPRESSLY STATES THAT ALL REPAIRS AND PARTS REPLACEMENTS SHOULD BE UNDERTAKEN BY CERTIFIED AND LICENSED TECHNICIANS, AND NOT BY THE BUYER. THE BUYER ASSUMES ALL RISK AND LIABILITY ARISING OUT OF HIS OR HER REPAIRS TO THE ORIGINAL PRODUCT OR REPLACEMENT PARTS THERETO, OR ARISING OUT OF HIS OR HER SETUP OF REPLACEMENT PARTS THERETO.

Record Product's Serial Number Here: _____

Note: If product has no serial number, record month and year of purchase instead.

Note: Some parts are listed and shown for illustration purposes only, and are not available individually as replacement parts. Specify UPC 193175344427 when ordering parts.

Parts List and Diagram

Part	Description
1	Hook
2	Frame
3	Stop Pawl Spring
4	Stop Pawl Trigger

Part	Description
5	Ratchet
6	Drive Pawl
7	Guard
8	Drive Pawl Spring

Part	Description
9	Wire Rope
10	Lever
11	Pulley Hook
12	End Hook

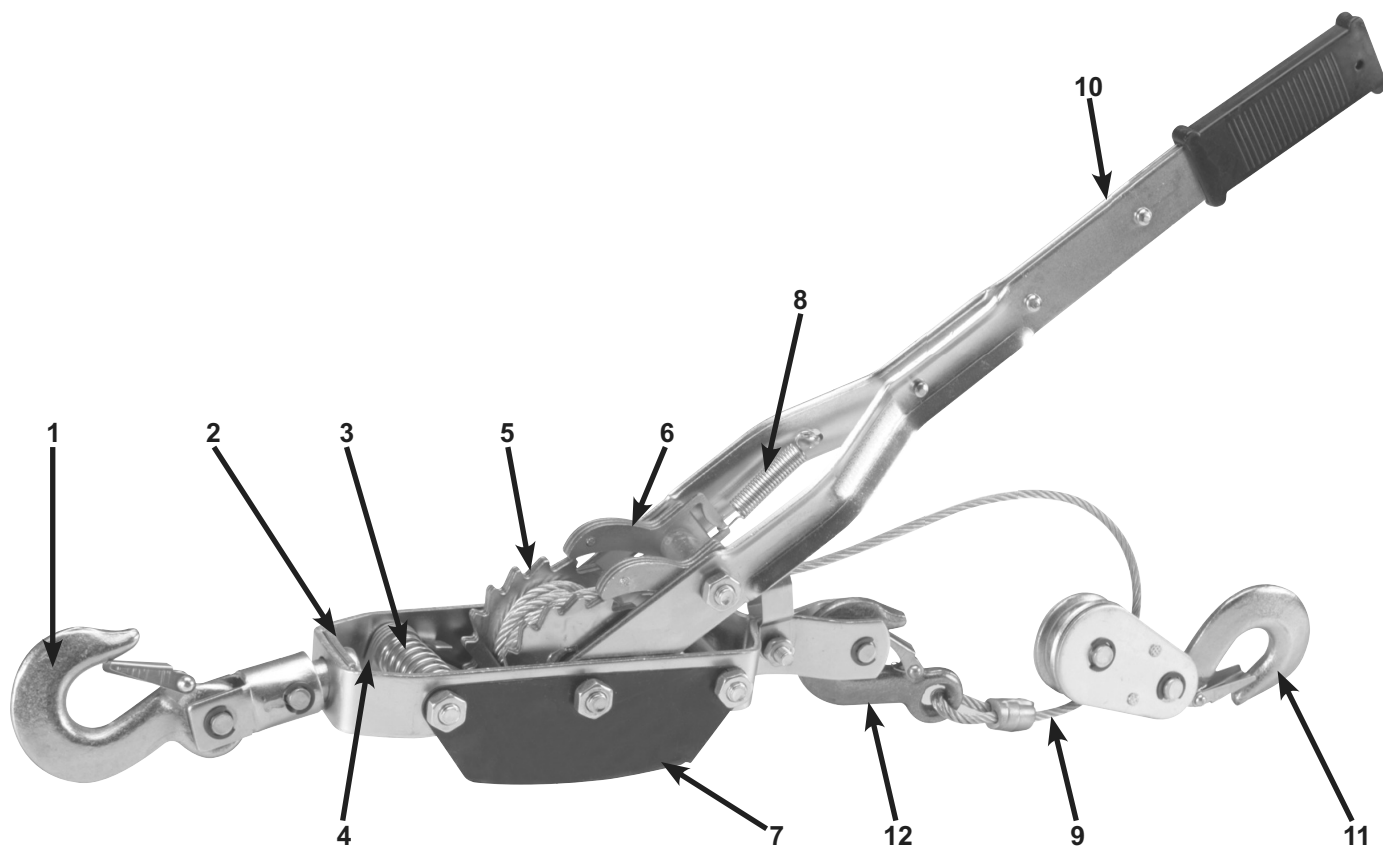

SAFETY

SETUP

OPERATION

INSPECTION

Limited 90 Day Warranty

Harbor Freight Tools Co. makes every effort to assure that its products meet high quality and durability standards, and warrants to the original purchaser that this product is free from defects in materials and workmanship for the period of 90 days from the date of purchase. This warranty does not apply to damage due directly or indirectly, to misuse, abuse, negligence or accidents, repairs or alterations outside our facilities, criminal activity, improper setup, normal wear and tear, or to lack of maintenance. We shall in no event be liable for death, injuries to persons or property, or for incidental, contingent, special or consequential damages arising from the use of our product. Some states do not allow the exclusion or limitation of incidental or consequential damages, so the above limitation of exclusion may not apply to you. THIS WARRANTY IS EXPRESSLY IN LIEU OF ALL OTHER WARRANTIES, EXPRESS OR IMPLIED, INCLUDING THE WARRANTIES OF MERCHANTABILITY AND FITNESS.

To take advantage of this warranty, the product or part must be returned to us with transportation charges prepaid. Proof of purchase date and an explanation of the complaint must accompany the merchandise. If our inspection verifies the defect, we will either repair or replace the product at our election or we may elect to refund the purchase price if we cannot readily and quickly provide you with a replacement. We will return repaired products at our expense, but if we determine there is no defect, or that the defect resulted from causes not within the scope of our warranty, then you must bear the cost of returning the product.

This warranty gives you specific legal rights and you may also have other rights which vary from state to state.



26677 Agoura Road • Calabasas, CA 91302 • 1-888-866-5797