

Owner's Manual & Safety Instructions

Save This Manual Keep this manual for the safety warnings and precautions, assembly, operating, inspection, maintenance and cleaning procedures. Write the product's serial number in the back of the manual (or month and year of purchase if product has no number). Keep this manual and the receipt in a safe and dry place for future reference.

22g

CENTRAL[®] MACHINERY

STEAM CLEANER KIT



70065

Visit our website at: <http://www.harborfreight.com>
Email our technical support at: productsupport@harborfreight.com

When unpacking, make sure that the product is intact and undamaged. If any parts are missing or broken, please call 1-888-866-5797 as soon as possible.

⚠️ WARNING

**Read this material before using this product.
Failure to do so can result in serious injury.
SAVE THIS MANUAL.**

Copyright © 2022 by Harbor Freight Tools®. All rights reserved.

No portion of this manual or any artwork contained herein may be reproduced in any shape or form without the express written consent of Harbor Freight Tools. Diagrams within this manual may not be drawn proportionally. Due to continuing improvements, actual product may differ slightly from the product described herein. Tools required for assembly and service may not be included.

Table of Contents





Safety	2	Maintenance	11
Specifications	4	Parts List and Diagram	14
Setup	5	Warranty	16
Operation.....	6		

SAFETY

SETUP

OPERATION

MAINTENANCE

WARNING SYMBOLS AND DEFINITIONS	
	This is the safety alert symbol. It is used to alert you to potential personal injury hazards. Obey all safety messages that follow this symbol to avoid possible injury or death.
	Indicates a hazardous situation which, if not avoided, will result in death or serious injury.
	Indicates a hazardous situation which, if not avoided, could result in death or serious injury.
	Indicates a hazardous situation which, if not avoided, could result in minor or moderate injury.
	Addresses practices not related to personal injury.

Instructions Pertaining to a Risk of Fire, Electric Shock, or Injury to Persons

IMPORTANT SAFETY INSTRUCTIONS

When using an electrical appliance, basic precautions should always be followed, including the following:

READ ALL INSTRUCTIONS BEFORE USING THIS APPLIANCE

WARNING

To reduce the risk of burns, fire, electric shock, or injury:

- Do not leave appliance when plugged in. Unplug from outlet when not in use and before servicing.
- Unplug from outlet and allow to cool completely before opening tank or adding water to tank.
- Do not touch steam nozzle or accessories or connect accessories while unit is plugged in.
- Only use water, do not use cleaning agents, they could cause injury or damage.
- Use only on flat, level surface.
- Do not allow children to use this item or use it near children. Not a toy.
- Use only as described in this manual. Use only manufacturer's recommended attachments.
- Do not use with damaged cord or plug. If appliance is not working as it should, has been dropped, damaged, left outdoors, or dropped into water, return it to a service center.
- Do not pull or carry by cord, use cord as a handle, close a door on cord, or pull cord around sharp edges or corners. Do not run appliance over cord. Keep cord away from heated surfaces.
- Do not unplug by pulling on cord. To unplug, grasp the plug, not the cord.
- Do not handle plug or appliance with wet hands.
- Not for space heating purposes.
- Turn off all controls before unplugging.
- Use extra care when cleaning on stairs.
- Connect to a properly grounded outlet only. See Grounding Instructions.

- 16. FOR HOUSEHOLD USE ONLY.
- 17. Do not immerse in liquid.
- 18. Do not point nozzle toward body, other people, animals or plants.
- 19. Do not point nozzle toward electrical outlets.
- 20. Do not operate without water in the tank.
- 21. Stay alert, watch what you are doing and use common sense when operating an appliance. Do not use an appliance while you are tired or under the influence of drugs, alcohol or medication. A moment of inattention while operating appliances may result in serious personal injury.
- 22. Maintain labels and nameplates on the appliance. These carry important safety information. If unreadable or missing, contact Harbor Freight Tools for a replacement.
- 23. The warnings, precautions, and instructions discussed in this instruction manual cannot cover all possible conditions and situations that may occur. It must be understood by the operator that common sense and caution are factors which cannot be built into this product, but must be supplied by the operator.



SAVE THESE INSTRUCTIONS

Grounding Instructions

This appliance must be grounded. If it should malfunction or breakdown, grounding provides a path of least resistance for electric current to reduce the risk of electric shock. This appliance is equipped with a cord having an equipment-grounding conductor and grounding plug. The plug must be inserted into an appropriate outlet that is properly installed and grounded in accordance with all local codes and ordinances.

WARNING



Improper connection of the equipment-grounding conductor can result in a risk of electric shock. Check with a qualified electrician or service person if you are in doubt as to whether the outlet is properly grounded. Do not modify the plug provided with the appliance – if it will not fit the outlet, have a proper outlet installed by a qualified electrician.

This appliance is for use on a nominal 120-V circuit and has a grounding attachment plug that looks like the plug illustrated in **125VAC 3-Prong Plug and Outlet**. Make sure that the appliance is connected to an outlet having the same configuration as the plug. No adaptor should be used with this appliance.

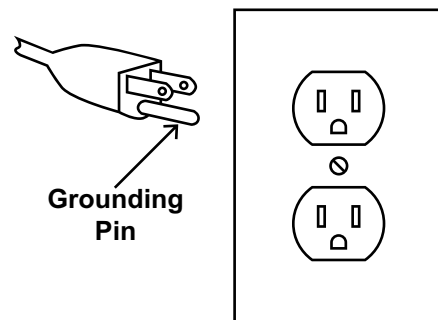

125VAC 3-Prong Plug and Outlet
(for up to 125VAC and up to 15A)

Specifications

Electrical Rating	120VAC / 60Hz / 12.5A
Maximum Boiler Temperature	280° F

SAFETY

SETUP

OPERATION

MAINTENANCE

CENTRAL[®]
MACHINERY

Setup - Before Use:



Read the **ENTIRE IMPORTANT SAFETY INFORMATION** section at the beginning of this manual including all text under subheadings therein before set up or use of this product.

Components and Controls



SAFETY

SETUP

OPERATION

MAINTENANCE

Operating Instructions



Read the **ENTIRE IMPORTANT SAFETY INFORMATION** section at the beginning of this manual including all text under subheadings therein before set up or use of this product.

WARNING

TO PREVENT SERIOUS INJURY FROM ACCIDENTAL OPERATION:
Turn the Switch off and unplug the power cord from its electrical outlet before changing attachments or filling tank.

Filling Tank

WARNING! To prevent steam burns when filling tank:

1. Turn off and unplug unit, then let unit cool for 20 minutes.
2. After unit has cooled, press and hold Trigger to release residual steam pressure before removing Tank Cap.
3. Remove Tank Cap by pushing and holding Cap down while turning counterclockwise.

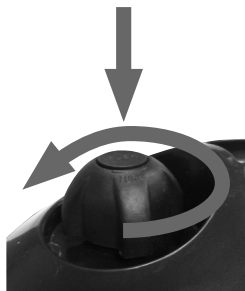

4. Empty remaining water from Tank.
5. Fill the Measuring Cup with **distilled water** no higher than the 27 oz (800 ml) mark.

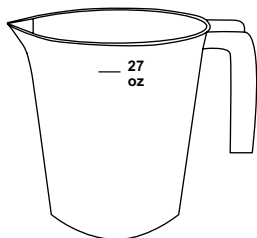

NOTICE: To prevent damage to Steam Cleaner, use distilled water, do not add chemicals to water, and do not overfill tank.

6. Place Funnel in Fill Port, then pour distilled water in Funnel.



7. Replace Tank Cap by pushing and holding Cap down while turning clockwise until tightened securely.

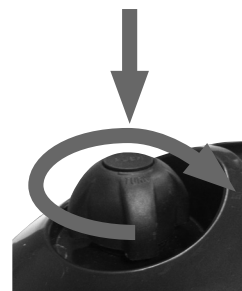

CENTRAL[®]

MACHINERY

Steam Cleaning

WARNING! POINT STEAM AWAY FROM PEOPLE, ANIMALS, PLANTS AND ELECTRICAL OUTLETS. To prevent steam burns when changing attachments, turn off and unplug unit, then let unit cool for 20 minutes. After unit has cooled, press and hold Trigger to release residual steam pressure before removing attachments.

NOTICE: To prevent damage to Steam Cleaner, avoid putting excessive pressure on attachments, let the Steam Cleaner do the work. To prevent damage to surfaces, perform a spot test on an inconspicuous area before steaming any surface.

Note: Steam Cleaner is equipped with thermal overload protection. If unit overheats, it will automatically switch off. If this happens, unplug unit and let cool for 20 minutes, fill tank as necessary, then plug back in and resume steaming.

CAUTION! Do not operate Steam Cleaner without water in the Tank.

1. Dust, sweep and/or vacuum surface before steaming.
2. Make sure Power Switch is in the OFF (O) position, unit is unplugged, and Trigger Lock is engaged.

To engage Trigger Lock, release Trigger, then push left side of lock until it is flush with housing. Trigger Lock is engaged when Trigger cannot move.



3. Connect attachment(s) appropriate for job. See **Connecting Attachments, starting on page 8.**

CAUTION! Do not steam clean without an attachment.

4. Plug Steam Cleaner into dedicated 120V outlet and press Power Switch on back of unit to ON position (I).

5. Green Power Light and red Steam Light will come on. When red Steam Light goes out, unit is ready to use.

Note: Water spattering from attachment at startup is normal.

6. Disengage Trigger Lock, then press Trigger to begin steaming. Keep Steam Cleaner moving to avoid oversaturating any one area.
7. To sanitize hard surfaces, hold attachment 1/2" from surface for 5 seconds.
8. Wipe surfaces with a cloth after steaming. Steam loosens dirt, but does not remove it.

CAUTION! To prevent burn injuries, allow surfaces to cool before wiping them.

Note: Tank will need to be refilled when steam flow decreases.

9. When finished, turn Power Switch to the OFF (O) position and unplug unit from outlet.
10. Let unit cool for 20 minutes, then clean and store according to **User-Maintenance and Storage on page 11.**

CENTRAL[®] MACHINERY

Connecting Attachments

Floor Brush - Hard Floors, Carpets and Rugs

NOTICE: Consult floor/carpet manufacturer's instructions before steam cleaning.

Do not use on painted surfaces. Do not use on unsealed, polished or waxed surfaces.

1. Floor Brush is packed separately from its Handle. Insert Handle into Floor Brush as shown below. Push all the way in, then twist Handle up to its normal position.

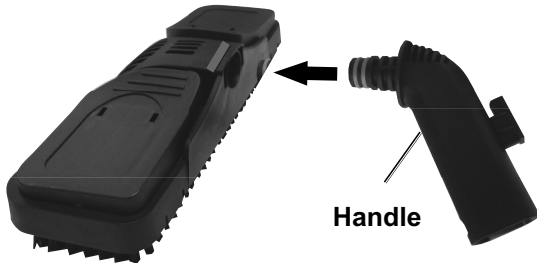

2. Attach one or both Extension Tubes to Nozzle:

Line up hole in Extension Tube with lock button on Nozzle and push together until Extension Tube clicks into place.

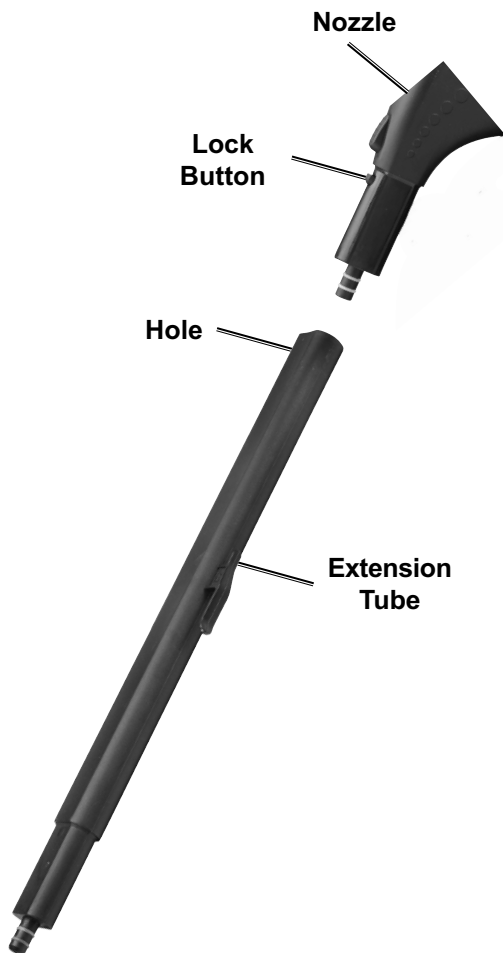

3. **Carpets and Rugs:** Attach Floor Brush to Extension Tube.

Line up hole in Floor Brush with lock button on Extension Tube and push together until Floor Brush clicks into place.



4. **Hard Floors:** Attach Floor Brush with Cloth to Extension Tube.

To attach Cloth, lay Floor Brush over Cloth, push down on clamps, tuck the ends of Cloth under clamps, then release clamps.

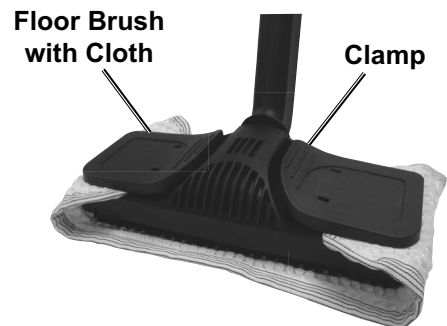

CAUTION! To prevent burn injury, wait until Cloth has cooled before removing from Floor Brush.

Note: Floor Brush may be stored on holder located on back of Unit.

SAFETY

SETUP

OPERATION

MAINTENANCE

Window Attachment - Windows, Shower Doors, Mirrors, Oven Doors and Tile

CAUTION! IN COLD WEATHER, GLASS MAY BREAK DUE TO THERMAL SHOCK!
To prevent injuries from broken glass, DO NOT place attachment directly on glass.
Warm the glass from a distance of 1 foot, then release Trigger and squeegee water away.

1. Attach one or both Extension Tubes to Nozzle if needed.
2. Attach Squeegee to Window Attachment:
 - a. Place Squeegee hooks through tabs on Window Attachment.
 - b. Pull Squeegee up until lock latches onto Window Attachment.
3. Slide Window Attachment handle onto Adapter, with hole facing left. Turn Adapter 1/4 turn clockwise until hole is facing up.

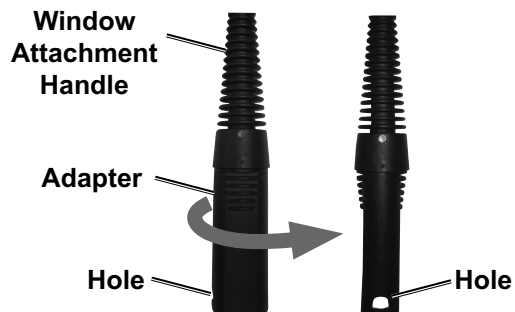
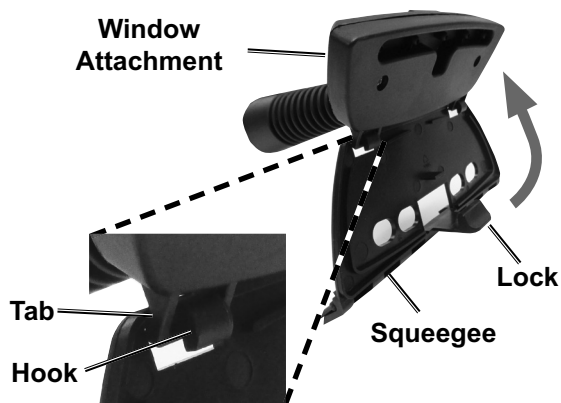

4. Line up hole in Adapter with lock button on Nozzle or Extension Tube and push together until Adapter clicks into place.

Brass Brush - Oven Racks and BBQ Grills

NOTE: Remove racks from oven before steaming.

1. Attach Adapter to Nozzle:

Line up hole in Adapter with lock button on Nozzle or Extension Tube and push together until Adapter clicks into place.

CAUTION! To prevent injury, wear heavy-duty work gloves when attaching Brass Brush.

2. Slide Brass Brush onto Adapter as far as possible.

NOTICE: Brass Brush may scratch some surfaces, such as stainless steel appliances.

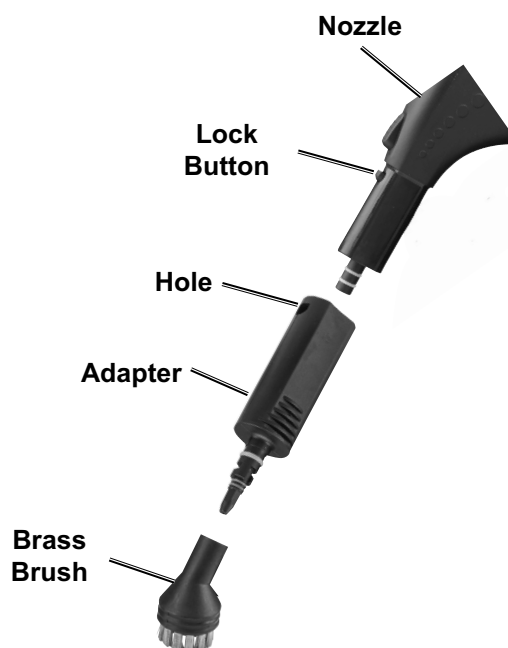

SAFETY

SETUP

OPERATION

MAINTENANCE

Upholstery Brush - Fabric, Upholstery, Curtains, Pillows and Mattresses

NOTICE: Consult fabric manufacturer's instructions before steam cleaning.
Do not use on leather, synthetic fabrics, velvet, acrylic or delicate fabrics.

1. Attach one or both Extension Tubes to Nozzle if needed.
2. Line up hole in Upholstery Brush with lock button on Nozzle or Extension Tube and push together until Upholstery Brush clicks into place.

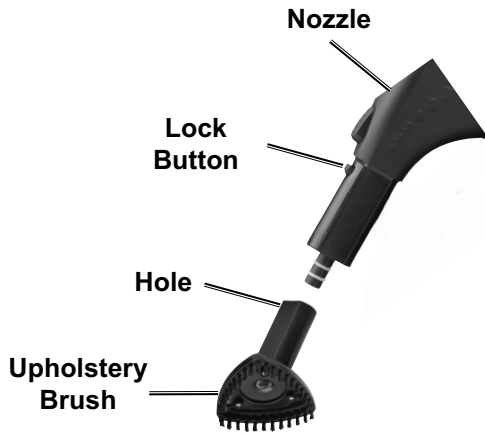

Countertops, Stoves, Ovens, Sinks, Toilets, Grout and Tight Spaces

1. Attach one or both Extension Tubes to Nozzle if needed.
2. Attach Adapter to Nozzle or Extension Tube:
Line up hole in Adapter with lock button on Nozzle or Extension Tube and push together until Adapter clicks into place.
3. Slide attachment onto Adapter as far as possible:
 - a. **Large Nylon Brush:** Loosens dirt from hard surfaces.
 - b. **Small Nylon Brush:** Cleans grout.
 - c. **Scrubber:** Removes tough dirt and scuffs.

NOTICE: Scrubber may scratch some surfaces, such as stainless steel appliances.

- d. **Jet:** Concentrates steam into tight spaces.

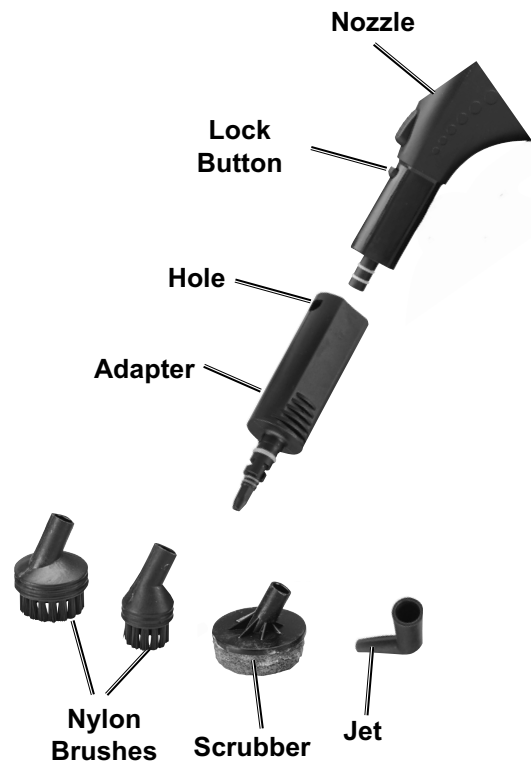

SAFETY

SETUP

OPERATION

MAINTENANCE



Procedures not specifically explained in this manual must be performed only by a qualified technician.

⚠️ WARNING

TO PREVENT SERIOUS INJURY FROM ACCIDENTAL OPERATION:

Turn the Power Switch of the appliance off and unplug the appliance from its electrical outlet before performing any procedure in this section.

TO PREVENT SERIOUS INJURY FROM APPLIANCE FAILURE:

Do not use damaged equipment. If abnormal noise or vibration occurs, have the problem corrected before further use.

Cleaning, Maintenance, and Lubrication

1. **BEFORE EACH USE**, inspect the general condition of the appliance. Check for:
 - loose hardware,
 - misalignment or binding of moving parts,
 - cracked or broken parts,
 - damaged electrical wiring, and
 - any other condition that may affect its safe operation.
2. **AFTER EVERY USE:**
 - a. After unit has cooled for 20 minutes, press and hold Trigger to release residual steam pressure.
 - b. Remove attachments and rinse them with water. Allow them to dry.
 - c. Empty tank, rinse with water, and allow tank to dry before replacing cap.
 - d. Wash Cloth separately in warm or hot water, then tumble or air dry. Do not use fabric softener.
 - e. Wipe external surfaces with clean, damp cloth.
 - f. Store in an indoor dry area out of reach of children.
3. **EVERY 3 - 6 MONTHS**, depending on water hardness, descale the tank:
 - a. Use limescale remover or equal parts vinegar and water.
 - b. Let solution sit in tank for 30 minutes, empty tank and rinse with water.
 - c. Repeat as necessary.
 - d. Allow tank to dry before replacing cap.
4. **⚠️ WARNING! If the supply cord of this appliance is damaged, it must be replaced only by a qualified service technician.**

Troubleshooting

SAFETY

SETUP

OPERATION

MAINTENANCE

Problem	Possible Causes	Likely Solutions
Unit will not heat up. Power light does not come on.	<ol style="list-style-type: none"> 1. Cord not connected. 2. No power at outlet. 3. Unit's thermal overload tripped. 4. Internal damage or wear. 	<ol style="list-style-type: none"> 1. Check that cord is plugged in. 2. Check power at outlet. If outlet is unpowered, turn off Unit and check circuit breaker. If breaker is tripped, make sure circuit is right capacity for Unit and circuit has no other loads. 3. Unplug Unit and allow to cool for 20 minutes. After cooled, plug in Unit and continue use. 4. Have technician service Unit.
Steam output is weak.	<ol style="list-style-type: none"> 1. Water level is low. 2. Mineral build up in tank. 	<ol style="list-style-type: none"> 1. Refill according to Note: Tank will need to be refilled when steam flow decreases. See Filling Tank on page 6. 2. Descale tank according to Cleaning, Maintenance, and Lubrication on page 11.
Excessive water in steam.	<ol style="list-style-type: none"> 1. Tank overfilled. 2. Unit not heated fully. 	<ol style="list-style-type: none"> 1. Fill tank according to Filling Tank on page 6. Only use included measuring cup to fill tank. 2. Wait until Steam Light goes out.



Follow all safety precautions whenever diagnosing or servicing the appliance. Disconnect power supply before service.

PLEASE READ THE FOLLOWING CAREFULLY

THE MANUFACTURER AND/OR DISTRIBUTOR HAS PROVIDED THE PARTS LIST AND ASSEMBLY DIAGRAM IN THIS MANUAL AS A REFERENCE TOOL ONLY. NEITHER THE MANUFACTURER OR DISTRIBUTOR MAKES ANY REPRESENTATION OR WARRANTY OF ANY KIND TO THE BUYER THAT HE OR SHE IS QUALIFIED TO MAKE ANY REPAIRS TO THE PRODUCT, OR THAT HE OR SHE IS QUALIFIED TO REPLACE ANY PARTS OF THE PRODUCT. IN FACT, THE MANUFACTURER AND/OR DISTRIBUTOR EXPRESSLY STATES THAT ALL REPAIRS AND PARTS REPLACEMENTS SHOULD BE UNDERTAKEN BY CERTIFIED AND LICENSED TECHNICIANS, AND NOT BY THE BUYER. THE BUYER ASSUMES ALL RISK AND LIABILITY ARISING OUT OF HIS OR HER REPAIRS TO THE ORIGINAL PRODUCT OR REPLACEMENT PARTS THERETO, OR ARISING OUT OF HIS OR HER INSTALLATION OF REPLACEMENT PARTS THERETO.

SAFETY

SETUP

OPERATION

MAINTENANCE

Parts List

SAFETY

SETUP

OPERATION

MAINTENANCE

Part	Description	Qty
1	Tank Cap	1
2	Spring	1
3	Core	1
4	Cover	1
5	Copper Ring	1
6	Sealing Ring	1
7	Sealing Ring	1
9	Top Housing	1
10	Silica Gel (13x20)	1
11	Steam Outlet	1
12	Screw (M5x30)	5
13	Tank Top Housing	1
14	Gasket	1
15	Tank Bottom Housing	1
16	Thermostat	1
17	Nut (M5)	5
18	Silica Gel (13x25)	5
19	Back Housing	1
20	Nozzle	1

Part	Description	Qty
21	Sealing Ring - Small	1
22	Sealing Ring - Large	1
25	Handle Left Housing	1
27	Handle Right Housing	1
28	Trigger	1
29	Trigger Lock	1
30	Threaded Pipe	1
31	Inner Pipe	1
32	Wheel Cover	2
33	Outer Wheel	2
34	Inner Wheel	2
35	Bottom Housing	1
36	Swivel Wheel Shaft	1
37	Swivel Wheel Housing	1
38	Swivel Wheel	1
39	Hose	1
40	Measuring Cup	1
41	Funnel	1

Record Product's Serial Number Here: _____

Note: If product has no serial number, record month and year of purchase instead.

Note: Some parts are listed and shown for illustration purposes only, and are not available individually as replacement parts. Specify UPC 193175488480 when ordering parts.

Assembly Diagram

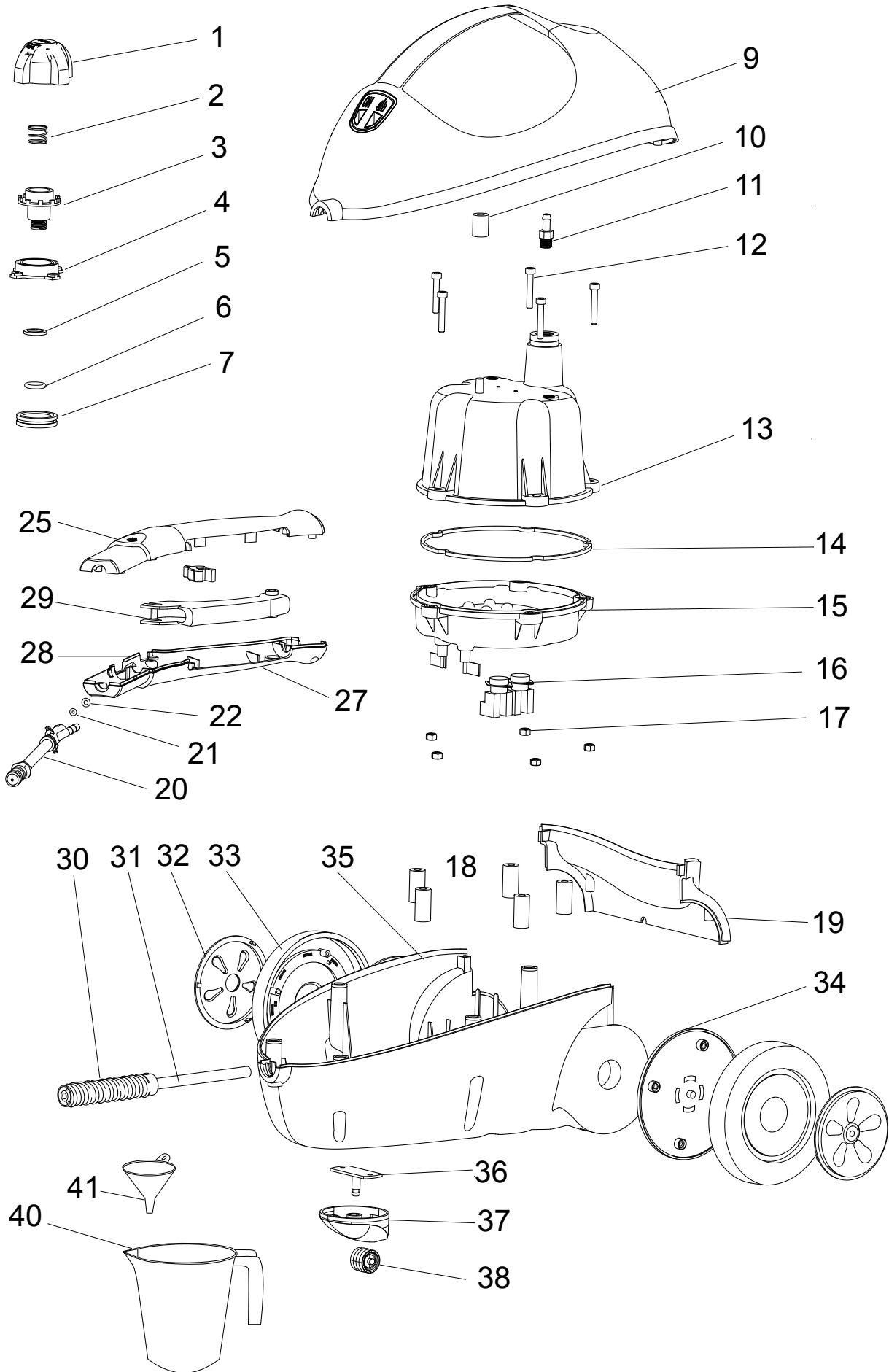

SAFETY

SETUP

OPERATION

MAINTENANCE

Limited 90 Day Warranty

Harbor Freight Tools Co. makes every effort to assure that its products meet high quality and durability standards, and warrants to the original purchaser that this product is free from defects in materials and workmanship for the period of 90 days from the date of purchase. This warranty does not apply to damage due directly or indirectly, to misuse, abuse, negligence or accidents, repairs or alterations outside our facilities, criminal activity, improper installation, normal wear and tear, or to lack of maintenance. We shall in no event be liable for death, injuries to persons or property, or for incidental, contingent, special or consequential damages arising from the use of our product. Some states do not allow the exclusion or limitation of incidental or consequential damages, so the above limitation of exclusion may not apply to you. THIS WARRANTY IS EXPRESSLY IN LIEU OF ALL OTHER WARRANTIES, EXPRESS OR IMPLIED, INCLUDING THE WARRANTIES OF MERCHANTABILITY AND FITNESS.

To take advantage of this warranty, the product or part must be returned to us with transportation charges prepaid. Proof of purchase date and an explanation of the complaint must accompany the merchandise. If our inspection verifies the defect, we will either repair or replace the product at our election or we may elect to refund the purchase price if we cannot readily and quickly provide you with a replacement. We will return repaired products at our expense, but if we determine there is no defect, or that the defect resulted from causes not within the scope of our warranty, then you must bear the cost of returning the product.

This warranty gives you specific legal rights and you may also have other rights which vary from state to state.

CENTRAL[®]
MACHINERY

26677 Agoura Road • Calabasas, CA 91302 • 1-888-866-5797