

Owner's Manual & Safety Instructions

Save This Manual Keep this manual for the safety warnings and precautions, assembly, operating, inspection, maintenance and cleaning procedures. Write the product's serial number in the back of the manual (or month and year of purchase if product has no number). Keep this manual and the receipt in a safe and dry place for future reference.

24d

PREDATOR[®] SUPER QUIET INVERTER

9500 WATT INVERTER GENERATOR

7600 RUNNING WATTS
9500 MAX STARTING WATTS



71365

Visit our website at: <http://www.harborfreight.com>
Email our technical support at: productsupport@harborfreight.com
Email our engine support at: predator@harborfreight.com

⚠ DANGER

Using a generator indoors CAN KILL YOU IN MINUTES.

Generator exhaust contains carbon monoxide. This is a poison you cannot see or smell.



NEVER use inside a home or garage, **EVEN IF** doors and windows are open.

Only use **OUTSIDE** and far away from windows, doors, and vents.

⚠ DANGER

Do not use in trailers, truck beds, or tents.

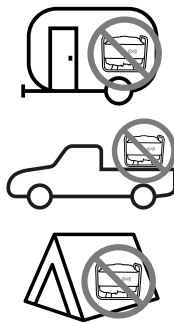

Use at least 20 feet away from people, animals, and structures with exhaust pointed away.

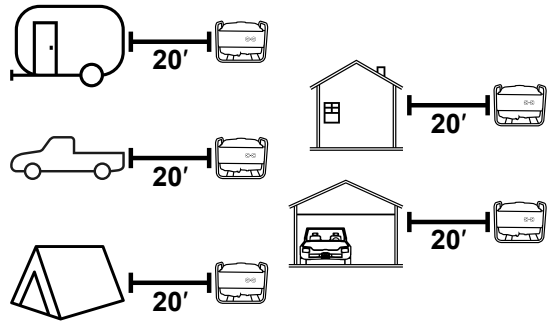

When unpacking, make sure that the product is intact and undamaged. If any parts are missing or broken, please call 1-888-866-5797 as soon as possible.

⚠ WARNING

Read this material before using this product. Failure to do so can result in serious injury. SAVE THIS MANUAL.

Copyright© 2024 by Harbor Freight Tools®. All rights reserved.

No portion of this manual or any artwork contained herein may be reproduced in any shape or form without the express written consent of Harbor Freight Tools. Diagrams within this manual may not be drawn proportionally. Due to continuing improvements, actual product may differ slightly from the product described herein.

Tools required for assembly and service may not be included.

Table of Contents





| | | | |
|----------------------|----|------------------------------|----|
| Specifications | 2 | Maintenance | 18 |
| Safety | 3 | Troubleshooting | 22 |
| Setup | 8 | Parts List and Diagram | 26 |
| Operation | 10 | Warranties | 30 |

Specifications



| | | |
|---------------------------------------|--------------|---|
| Generator | Output | 120/240VAC, 60Hz, 63.3 / 31.7A, 1 Phase 12VDC, 8A (nominal) 5V USB, 3.1A 7600 Running Watts 9500 Maximum Starting Watts |
| | Receptacles | 2x GFCI NEMA #5-20R (3-prong, 120VAC) 1x NEMA #L5-30R (3-prong, 120VAC) 1x NEMA #L14-30R (4-prong, 120/240 VAC) 1x 12VDC Two Pin Outlet 2 x USB-A Outlets Parallel Kit Terminals |
| | Battery Type | Contains non-replaceable battery: CR2032, 3V |
| Displacement | | 459cc |
| Compression Ratio | | 8.5:1 |
| Battery for Electric Start | | 12V, 14Ah Lead Acid |
| Engine Type | | Horizontal Single Cylinder 4-stroke, OHV |
| Cooling System | | Forced air cooled |
| Fuel | Type | 87+ octane, stabilizer-treated unleaded gasoline |
| | Capacity | 6.60 Gallon / 25.00 Liter |
| Engine Oil | Type SAE | 10W-30 |
| | Capacity | 37 fl. oz. |
| Run Time @ 25% Load with full tank | | 18.5 hr. |
| Sound Level at 23 feet, 25% load | | 67 dB(A) |
| Bore x Stroke | | 92mm x 69mm |
| Spark Plug | Type | BPR6ES (NGK) or equivalent |
| | Gap | 0.027"–0.031" |
| Valve Clearance | Intake | 0.0039"–0.0059" |
| | Exhaust | 0.0059"–0.0078" |
| Engine Speed | | 2560 - 3410 RPM |





The emissions control system for this Engine is warranted for standards set by the U.S. Environmental Protection Agency. For warranty information, refer to the last pages of this manual.

WARNING SYMBOLS AND DEFINITIONS

| | |
|---|--|
|  | This is the safety alert symbol. It is used to alert you to potential personal injury hazards. Obey all safety messages that follow this symbol to avoid possible injury or death. |
|  | Indicates a hazardous situation which, if not avoided, will result in death or serious injury. |
|  | Indicates a hazardous situation which, if not avoided, could result in death or serious injury. |
|  | Indicates a hazardous situation which, if not avoided, could result in minor or moderate injury. |
|  | Addresses practices not related to personal injury. |

Symbol Definitions

| Symbol | Property or Statement |
|---|---|
| RPM | Revolutions Per Minute |
| HP | Horsepower |
| AWG | American Wire Gauge |
|  | WARNING marking concerning Risk of Eye Injury. Wear ANSI-approved safety goggles with side shields. |
|  | Read the manual before set-up and/or use. |

| Symbol | Property or Statement |
|---|--|
|  | WARNING marking concerning Risk of Hearing Loss. Wear hearing protection. |
|  | WARNING marking concerning Risk of Respiratory Injury. Operate engine OUTSIDE and far away from windows, doors, and vents. |
|  | WARNING marking concerning Risk of Fire while handling fuel. Do not smoke while handling fuel. |
|  | WARNING marking concerning Risk of Fire. Do not refuel while operating. Keep flammable objects away from engine. |

IMPORTANT SAFETY INSTRUCTIONS



WARNING! Read all instructions.

Failure to follow all instructions listed below may result in fire, serious injury and/or DEATH.

The warnings and precautions discussed in this manual cannot cover all possible conditions and situations that may occur. It must be understood by the operator that common sense and caution are factors which cannot be built into this product, but must be supplied by the operator.

SAVE THESE INSTRUCTIONS



Setup Precautions

SAFETY

1. Gasoline fuel and fumes are flammable, and potentially explosive. Use proper fuel storage and handling procedures. Do not store fuel or other flammable materials nearby.
2. Have multiple ABC class fire extinguishers nearby.
3. Operation of this equipment may create sparks that can start fires around dry vegetation. A spark arrestor may be required. The operator should contact local fire agencies for laws or regulations relating to fire prevention requirements.
4. Set up and use only on a flat, level, well-ventilated surface.
5. All connections and conduits from the Generator to the load must only be installed by trained and licensed electricians, and in compliance with all relevant local, state, and federal electrical codes and standards, and other regulations where applicable.
6. Connections for standby power to a building electrical system must be made by a qualified electrician. The connection must isolate the Generator power from utility power, and must comply with all applicable laws and electrical codes.
7. A transfer switch should be installed by a licensed electrician in compliance with all applicable laws and electrical codes.
8. Wear ANSI-approved safety goggles, heavy-duty work gloves, and dust mask/respirator during set up.
9. Use only lubricants and fuel recommended in the Specifications chart of this manual.
10. Improper connections to a building electrical system can allow electrical current from the Generator to backfeed into the utility lines. Such backfeed may electrocute utility company workers or others who contact the lines during a power outage, and the Generator may explode, burn, or cause fires when utility power is restored. Consult the utility company and a qualified electrician if intending to use the Generator for back up power.
11. Do not operate the Generator before grounding. The Generator must be earth-grounded in accordance with all relevant electrical codes and standards before operation.
12. Install carbon monoxide alarm(s) with battery backup in nearby buildings according to manufacturer's instructions.

SETUP

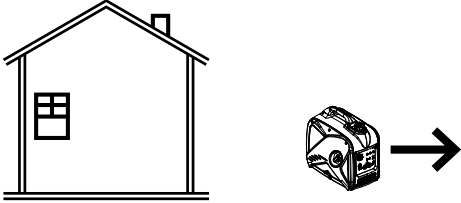
Operating Precautions

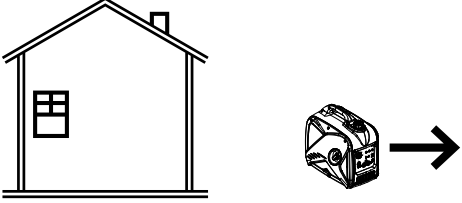
1.  **CARBON MONOXIDE HAZARD**
Using a generator indoors CAN KILL YOU IN MINUTES.
Generator exhaust contains carbon monoxide. This is a poison you cannot see or smell.

NEVER use inside a home or garage, EVEN IF doors and windows are open.

Only use OUTSIDE and far away from windows, doors, and vents.
2. **CARBON MONOXIDE SHUTOFF**
DANGER! TO PREVENT SERIOUS INJURY AND DEATH FROM CARBON MONOXIDE INHALATION: The Carbon Monoxide sensor is an additional layer of protection only. Do not use the Generator in any area or situation that will allow carbon monoxide to accumulate.
 - FLASHING RED LIGHT: Dangerous levels of carbon monoxide gas have built up and generator will shutoff. Leave immediately until area has aired out. Move Generator to well-ventilated area before operation.
 - FLASHING YELLOW LIGHT: Carbon monoxide sensor malfunction. Sensor needs service. Do not use the Generator until the sensor is working properly. For technical questions, please call 1-888-866-5797.
NOTE: Yellow light flashes once after starting to indicate passing self-check and is functioning normally.**Carbon Monoxide sensor must only be serviced by qualified technician to restore it to original settings. Do not modify or tamper with the Carbon Monoxide sensor. Not following these instructions can result in death or serious injury due to Carbon Monoxide sensor malfunction.**
3. Never use a generator indoors, including in garages, basements, crawl spaces and sheds. Opening doors and windows or using fans will NOT prevent carbon monoxide build up in the home.
4. When using generators, keep them outdoors and far away from open doors, windows, and vents to avoid toxic levels of carbon monoxide from building up indoors.

OPERATION

MAINTENANCE

Operating Precautions (continued)

5. If you start to feel sick, dizzy, or weak while using a generator, get to fresh air right away. The carbon monoxide from generators can quickly lead to full incapacitation and death.
6. Keep children away from the equipment, especially while it is operating.
7. Keep all spectators at least six feet from the engine during operation.
8. **Fire Hazard!** Do not fill gas tank while engine is running. Do not operate if gasoline has been spilled. Clean spilled gasoline before starting engine. Do not operate near pilot light or open flame.
9. Do not touch engine during use. Let engine cool down after use.
10. Never store fuel or other flammable materials near the engine.
11. If the plugged in product operates abnormally or unusually slow, immediately stop using the generator as a power source. Read and adhere to the instruction manual of the product to be powered to make sure that it can be safely and efficiently powered by a portable generator.
12. Before connecting an appliance or power cord to the generator: Make sure that it is in good working order. Faulty appliances or power cords can create a potential for electrical shock.
13. Do not exceed the running wattage of the generator. Make sure that the total electrical rating of the all of the tools or appliances plugged into the generator at the same time does not exceed that of the generator. Check that the startup surge will not be beyond the limit of the generator.
14. Avoid substantially overloading which will trip the circuit breaker. Slightly overloading the generator may not trip the circuit breaker, but will lead to premature generator failure.
15. Do not attempt to connect or disconnect load connections while standing in water, or on wet or soggy ground.
16. Do not touch electrically energized parts of the generator and interconnecting cables or conductors with any part of the body, or with any non-insulated conductive object.
17. Connect the generator only to a load that is compatible with the electrical characteristics and running wattage of the generator.
18. Insulate all connections and disconnected wires.
19. Guard against electric shock. Prevent body contact with grounded surfaces such as pipes, radiators, ranges, and refrigerators.
20. Only use a suitable means of transport and lifting devices with sufficient weight bearing capacity when transporting the generator.
21. Secure the generator on transport vehicles to prevent it from rolling, slipping, and tilting.
22. Industrial applications must follow OSHA requirements.
23. Do not leave the generator unattended when it is running. Turn off the generator (and remove safety keys, if available) before leaving the work area.
24. The generator can produce high noise levels. Prolonged exposure to noise levels above 85 dBA is hazardous to hearing. Wear ear protection when operating the generator or when working nearby while it is operating.
25. Keep access doors on enclosures locked.
26. Wear ANSI-approved safety glasses and hearing protection during use.
27. People with pacemakers should consult their physician(s) before use. Electromagnetic fields in close proximity to a heart pacemaker could cause pacemaker interference or pacemaker failure. Caution is necessary when near the engine's magneto or recoil starter.
28. Use only accessories that are recommended by Harbor Freight Tools for your model. Accessories that may be suitable for one piece of equipment may become hazardous when used on another piece of equipment.
29. Do not operate in explosive atmospheres, such as in the presence of flammable liquids, gases, or dust. Gasoline-powered engines may ignite the dust or fumes.
30. Stay alert, watch what you are doing and use common sense when operating this generator. Do not use while tired or under the influence of drugs, alcohol or medication.
31. Dress properly. Do not wear loose clothing or jewelry. Keep hair, clothing and gloves away from moving parts. Loose clothes, jewelry or long hair can be caught in moving parts.
32. Parts, especially exhaust system components, get very hot during use. Stay clear of hot parts.
33. Do not cover the generator during operation.
34. Keep the generator and surrounding area clean at all times. Keep generator at least 5 feet from combustible objects.
35. Do not smoke, or allow sparks, flames, or other sources of ignition around the equipment, especially when refuelling.
36. Use the equipment, accessories, etc., in accordance with these instructions and in the manner intended for the particular type of equipment, taking into account the working conditions and the work to be performed. Use of the equipment for operations different from those intended could result in a hazardous situation.
37. Do not operate the equipment with known leaks in the engine's fuel system.

38. When spills of fuel or oil occur, they must be cleaned up immediately. Dispose of fluids and cleaning materials as per any local, state, or federal codes and regulations. Store oil rags in a bottom-ventilated, covered, metal container.
39. Keep hands and feet away from moving parts. Do not reach over or across equipment while operating.
40. Before use, check for misalignment or binding of moving parts, breakage of parts, and any other condition that may affect the equipment's operation. **If damaged, have the equipment serviced before using.** Many accidents are caused by poorly maintained equipment.
41. Use the correct equipment for the application. Do not modify the equipment and do not use the equipment for a purpose for which it is not intended.
42. Extension Cord - Make sure your extension cord is in good condition. When using an extension cord, be sure to use one heavy enough to carry the current your product will draw. An undersized extension cord will cause a drop in line voltage resulting in loss of power and overheating. The table below shows the correct cord size to use depending on cord length and nameplate ampere rating. If in doubt, use the next heavier gauge. The smaller the gauge number, the heavier the cord.

RECOMMENDED MINIMUM WIRE GAUGE FOR EXTENSION CORDS

| CURRENT (AMPS) | Load @ 120V (WATTS) | Load @ 240V (WATTS) | 0 ~ 50 ft | 50 ~ 75 ft | 75 ~ 100 ft |
|----------------|---------------------|---------------------|-----------|------------|-------------|
| 2 | 240 | 480 | 18 AWG | | |
| 4 | 480 | 960 | 18 AWG | | 16 AWG |
| 6 | 720 | 1440 | 18 AWG | 16 AWG | 14 AWG |
| 8 | 960 | 1920 | 16 AWG | | 12 AWG |
| 10 | 1200 | 2400 | 16 AWG | 14 AWG | 12 AWG |
| 15 | 1800 | 3600 | 14 AWG | 12 AWG | 10 AWG |
| 20 | 2400 | 4800 | 12 AWG | 10 AWG | |
| 25 | 3000 | 6000 | 12 AWG | 10 AWG | 8 AWG |
| 30 | 3600 | 7200 | 10 AWG | 8 AWG | |
| 35 | 4200 | 8400 | 8 AWG | 6 AWG | |
| 40 | 4800 | 9600 | 6 AWG | | |

Parallel Kit Precautions

⚠ WARNING TO PREVENT SERIOUS INJURY, DEATH, AND GENERATOR AND/OR EQUIPMENT DAMAGE FROM ELECTRIC SHOCK AND FIRE:

1. Follow Parallel Kit instructions provided with Kit for connection and use of a Parallel Kit.
2. Only connect two identical Inverter Generators together using a Parallel Kit.
3. Connect Parallel Kit only to terminals marked "Parallel Outlets" on the front of the Generator.
4. Do not remove or connect a Parallel Kit while the Generator is running.
5. Do not use a Parallel Kit that is attached to only one Generator.

Service Precautions

- Before service, maintenance, or cleaning:**
 - Unplug all devices from the generator.**
 - Turn the Combination Switch to its "OFF" position.**
 - Disconnect the negative battery terminal.**
 - Allow the engine to completely cool.**
 - Then, remove the spark plug cap from the spark plug.**
- Keep all safety guards in place and in proper working order. Safety guards include muffler, air cleaner, mechanical guards, and heat shields, among other guards.
- Keep all electrical equipment clean and dry.** Replace any wiring where the insulation is cracked, cut, abraded, or otherwise degraded. Replace terminals that are worn, discolored, or corroded. Keep terminals clean and tight.
- Do not alter or adjust any part of the equipment or its engine that is sealed by the manufacturer or distributor. Only a qualified service technician may adjust parts that may increase or decrease governed engine speed.**
- Wear ANSI-approved safety goggles, heavy-duty work gloves, and dust mask/respirator during service.
- Maintain labels and nameplates on the equipment. These carry important information. If unreadable or missing, contact Harbor Freight Tools for a replacement.
- Have the equipment serviced by a qualified repair person using only identical replacement parts. This will ensure that the safety of the equipment is maintained. Do not attempt any service or maintenance procedures not explained in this manual or any procedures that you are uncertain about your ability to perform safely or correctly.
- Store equipment out of the reach of children.
- Follow scheduled engine and equipment maintenance.

Refueling:

- Do not refill the fuel tank while the engine is running or hot.
- Do not smoke, or allow sparks, flames, or other sources of ignition around the equipment, especially when refuelling.
- Do not fill fuel tank to the top.** Leave a little room for the fuel to expand as needed.
- Refuel in a well-ventilated area only.
- Wipe up any spilled fuel and allow excess to evaporate before starting engine.
To prevent FIRE, do not start the engine while the smell of fuel hangs in the air.

Button/Coin Battery Safety

| ⚠ WARNING | |
|--|--|
| <ul style="list-style-type: none">• INGESTION HAZARD: This product contains a button cell or coin battery.• DEATH or serious injury can occur if ingested.• A swallowed button cell or coin battery can cause Internal Chemical Burns in as little as 2 hours.• KEEP new and used batteries OUT OF REACH OF CHILDREN• Seek immediate medical attention if a battery is suspected to be swallowed or inserted inside any part of the body. |  |

-  This symbol means:
INGESTION HAZARD: This product contains a button cell or coin battery.
- Remove and immediately recycle or dispose of used batteries according to local regulations and keep away from children. Do NOT dispose of batteries in household trash or incinerate.
 - Even used batteries may cause severe injury or death.
 - Call a local poison control center for treatment information.
 - Non-rechargeable batteries are not to be recharged.
 - Do not force discharge, recharge, disassemble, heat above 140° Fahrenheit or incinerate. Doing so may result in injury due to venting, leakage or explosion resulting in chemical burns.



SAVE THESE INSTRUCTIONS.

Set Up



Read the **ENTIRE IMPORTANT SAFETY INFORMATION** section at the beginning of this manual including all text under subheadings therein before set up or use of this product.

WARNING

TO PREVENT SERIOUS INJURY AND FIRE: Operate only with proper spark arrestor installed.



Operation of this equipment may create sparks that can start fires around dry vegetation. A spark arrestor may be required. The operator should contact local fire agencies for laws or regulations relating to fire prevention requirements.

At high altitudes, the engine's carburetor, governor, and any other parts that control the fuel-air ratio will need to be adjusted by a qualified mechanic to allow efficient high-altitude use and to prevent damage to the engine and any other devices used with this product.

Grounding

The Generator must be properly grounded in accordance with all relevant electrical codes and standards before operation. In many locations, local code will not require this generator to be grounded when used with cord and plug equipment plugged directly into the receptacles on the generator. However, your local regulations may require the generator to be grounded. Contact a licensed electrician or consult local authorities regarding local grounding requirements. If grounding is required, have the unit grounded by a qualified electrician if you are not qualified to do so.

General grounding instructions are as follows:

Use one of the following as the grounding electrode:

Pipe or conduit, minimum $\frac{3}{4}$ in. diameter, minimum 8 ft. long. If steel, it must have anti-corrosion coating.

Rod, stainless steel or copper- or zinc-coated steel, minimum $\frac{5}{8}$ in. diameter, minimum 8 ft. long.

1. Drive electrode at least 8 ft vertically into the ground.
 - a. If rock layer prevents vertical entry, drive at an angle not exceeding 45 degrees from vertical.
 - b. If rock layer prevents angle entry, bury electrode in horizontal trench at least 30 in. deep.
2. The upper end of electrode must be protected if above ground level.
3. Connect a #6 AWG grounding wire (not included) from the Grounding Terminal on the Generator Control Panel to the buried electrode.

For additional information on grounding methods, please see the National Electrical Code.

Note: There is a permanent conductor between the portable generator inverter module (Neutral Conductor) and the frame.

Electric Starter Battery Connection

For the electric start function, the included 12VDC Battery must be connected before first use.

1. Remove the Battery Access Panel.
2. Make sure the black strap stretches over the top of the Battery and hooks into the Battery Platform.
3. Remove the covers from the Battery Terminals.
4. Locate the black and red battery cables.

5. Connect the red cable to the positive battery terminal first. Then connect the black cable to the negative battery terminal.
6. Replace the Battery Access Panel.

Note: This generator is equipped with a battery charging circuit specific to the installed battery type that will charge the battery when the Generator is running. If battery needs charging during storage, make sure to use a proper lead acid charger (not provided). Unplug charger when battery is fully charged.

Components and Controls

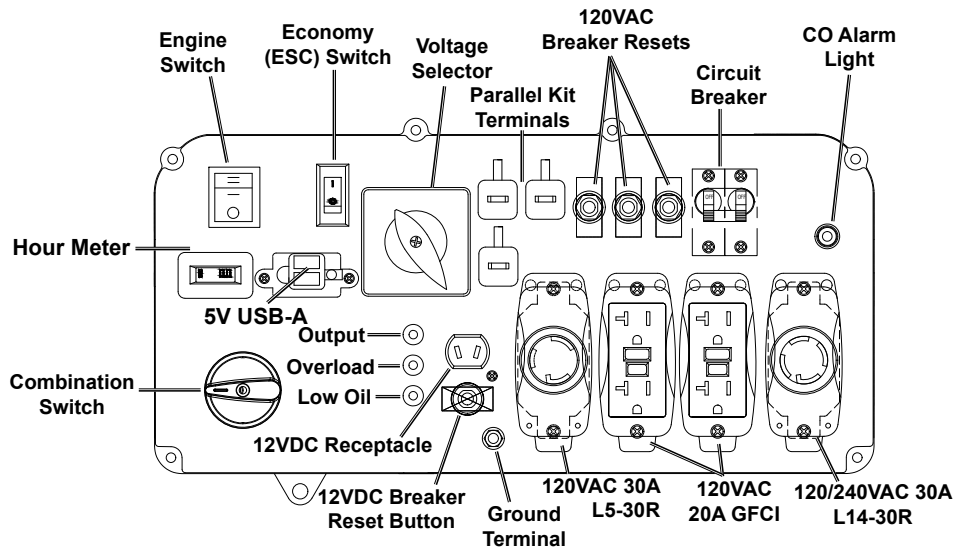

Figure A: Control Panel

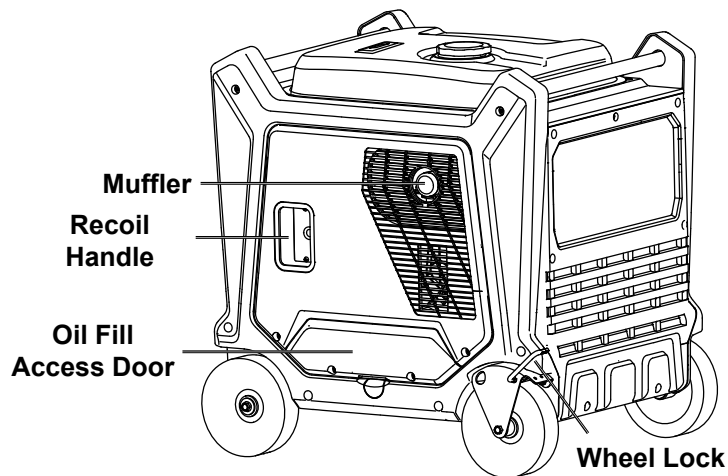
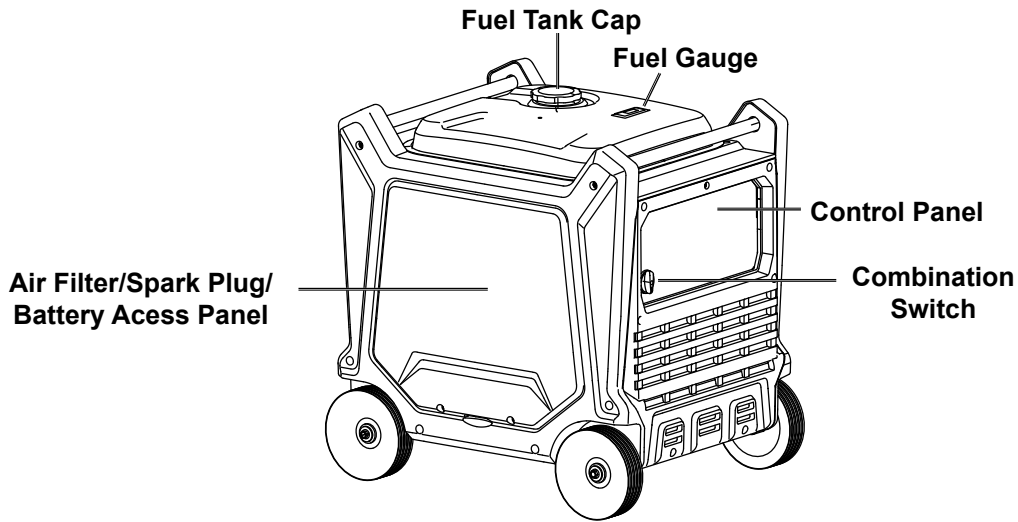

Figure B: Generator Components

WARNING! TO PREVENT SERIOUS INJURY: Follow Parallel Kit instructions for connection and use of a Parallel Kit (Parallel Kit and instructions sold separately). Generator must be in 120V/240V mode for parallel function.

Operation

⚠ Read the **ENTIRE IMPORTANT SAFETY INFORMATION** section at the beginning of this manual including all text under subheadings therein before set up or use of this product.

Pre-Start Checks

Inspect Engine and Generator looking for damaged, loose, and missing parts before set up and starting. If any problems are found, do not use equipment until fixed properly.

Checking and Filling Engine Oil

NOTICE: Generator is shipped without engine oil. Engine's crankcase **MUST** be filled with oil before first use. Your Warranty is **VOID** if the Engine's crankcase is not properly filled with oil before first use and before each use thereafter. Before each use, check the oil level. Engine will not start with low or no engine oil.

1. Make sure the Engine is stopped and is level.
2. On the left side of the Generator, loosen the Screw and remove the Oil Fill Access Door, as shown to the right.
3. Clean the top of the Oil Fill Cap/Dipstick and the area around it. Remove the Cap/Dipstick, turning it counterclockwise.
4. Check the oil level. The oil level should be up to the edge of the hole as shown.
5. As needed, add the appropriate type of oil until the oil level is at the proper level. SAE 10W-30 oil is recommended for general use.
6. Thread the Oil Fill Cap/Dipstick back in clockwise and replace the Oil Fill Access Door.

NOTICE: Do not run the engine with too little oil. Engine will shut off if engine oil level is too low.

Checking and Filling Fuel



⚠ WARNING! TO PREVENT SERIOUS INJURY FROM FIRE:

Fill the fuel tank in a well-ventilated area away from ignition sources. If the Engine is hot from use, shut the Engine off and wait for it to cool before adding fuel. Do not smoke.

1. Clean the Fuel Cap and the area around it.
2. Unscrew and remove the Fuel Cap.
3. Remove the Strainer and remove any dirt and debris. Then replace the Strainer.

Note: Do not use gasoline containing more than 10% ethanol (E10). Do not use E85 ethanol. Add fuel stabilizer to the gasoline or the Warranty is VOID.

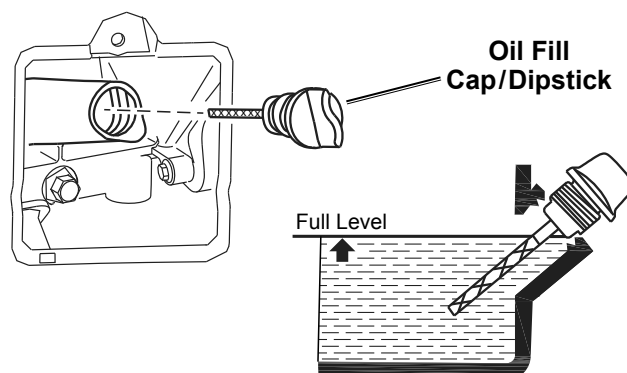
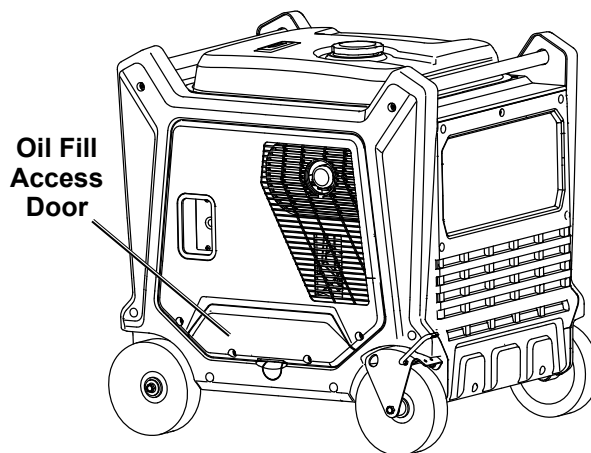

Note: Do not use gasoline that has been stored in a metal fuel container or a dirty fuel container. It can cause particles to enter the carburetor, affecting Engine performance and/or causing damage.

4. If needed, fill the Fuel Tank to about 1 inch under the fill neck of the Fuel Tank with 87 octane or higher unleaded gasoline that has been treated with a fuel stabilizer additive. Follow fuel stabilizer manufacturer's recommendations for use.
5. Replace the Fuel Cap.
6. Wipe up any spilled fuel and allow excess to evaporate before starting engine. To prevent FIRE, do not start the engine while the smell of fuel hangs in the air.

Starting the Engine

Before Starting the Engine



- Inspect the generator and engine.
- Disconnect all electrical loads from the generator.
- Fill the engine with the proper amount and type of both stabilizer-treated unleaded gasoline and oil.

Manual Start

1. Turn the Economy Switch to the OFF position.

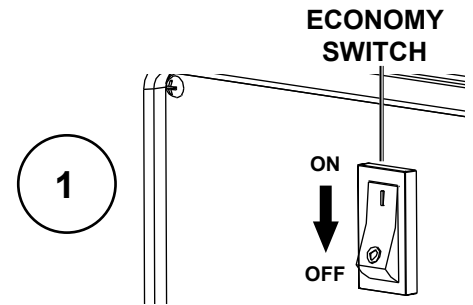

2. Turn the Combination Switch to the START position.

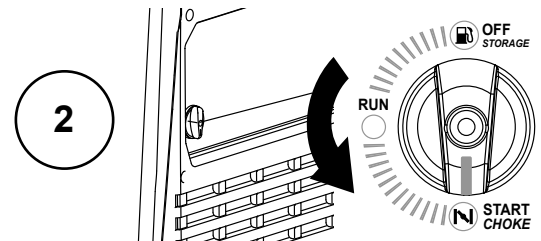

3. Turn the Engine Switch to the ON position.

4. Grip the Starter Handle of the Engine loosely and pull it slowly several times to allow the gasoline to flow into the Engine's carburetor. Then pull the Starter Handle gently until resistance is felt. Allow Cable to retract fully and then pull it quickly. Repeat until the Engine starts. Do not let the Starter Handle snap back against the housing. Hold it as it recoils so it doesn't hit the housing.

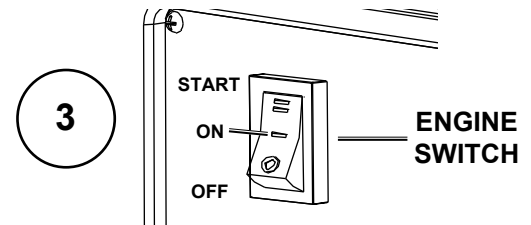

5. After the engine starts, allow to run for 20 seconds then turn the Combination Switch to the RUN position.

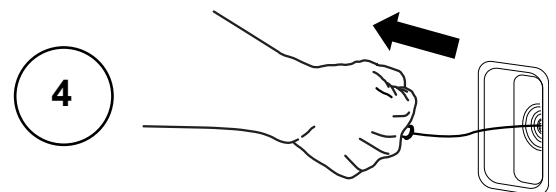

If engine does not start:

- **Check engine oil level.**
Engine will not start with low or no engine oil.
- **Check spark arrestor cleanliness.**
Engine will not start if spark arrestor is clogged.
- **For warm engine** – turn Combination Switch to RUN before trying to start it again.

Note: Moving the Combination Switch too fast could stall the Engine.

IMPORTANT: Allow the Engine to run at no load for five minutes after each start-up so that the Engine can stabilize.

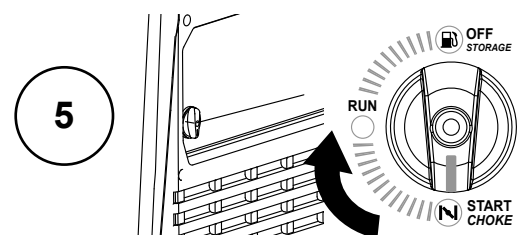

Electric Start

SAFETY

1. Turn the Economy Switch to the OFF position.
2. Turn the Combination Switch to the START position.

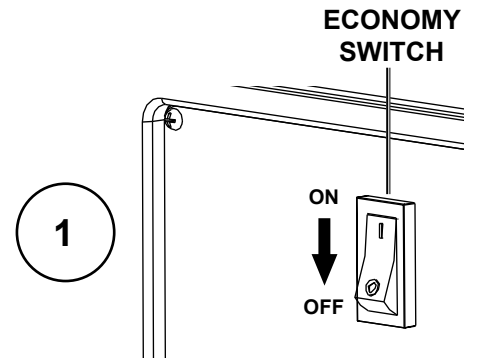

SETUP

3. Turn the Engine Switch to START position to start the Engine. If Engine does not start within 3 seconds, release Starter Button. Wait at least 10 seconds, then try again.
4. After the engine starts, allow to run for 20 seconds then turn the Combination Switch to the RUN position.

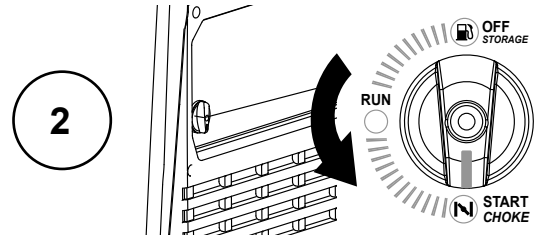

OPERATION

Note: If engine does not start, check engine oil level. Engine will not start with low or no engine oil.

Note: If warm engine does not start, turn Combination Switch to RUN before trying to start it again.

Note: Moving the Combination Switch too fast could stall the Engine.

IMPORTANT: Allow the Engine to run at no load for five minutes after each start-up so that the Engine can stabilize.

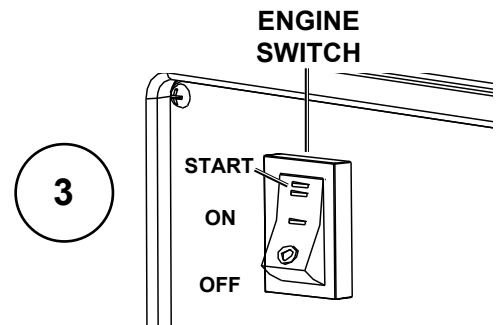

CARBON MONOXIDE SHUTOFF

DANGER! TO PREVENT SERIOUS INJURY AND DEATH FROM CARBON MONOXIDE INHALATION: The Carbon Monoxide sensor is an additional layer of protection only. Do not use the Generator in any area or situation that will allow carbon monoxide to accumulate.

- **FLASHING RED LIGHT:**
Dangerous levels of carbon monoxide gas have built up. Leave immediately until area has aired out. Move Generator to well-ventilated area before operation.

- **FLASHING YELLOW LIGHT:**
Carbon monoxide sensor malfunction. Sensor needs service. Call 1-888-866-5797 as soon as possible. Do not use the Generator until the sensor is working properly.
NOTE: Yellow light flashes once after starting to indicate passing self-check and is functioning normally.

Carbon Monoxide sensor must only be serviced by qualified technician to restore it to original settings. Do not modify or tamper with the Carbon Monoxide sensor. Not following these instructions can result in death or serious injury due to Carbon Monoxide sensor malfunction.

MAINTENANCE

Break-in Period

- Breaking-in the Engine will help to ensure proper equipment and Engine operation.
- The break-in period will last about 30 hours of use.
DO NOT exceed 75% of the Generator's running wattage during this period.
 - Change the engine oil after this period.

Under normal operating conditions subsequent maintenance follows the schedule explained in the **MAINTENANCE** section.

Nominal 12VDC Output

- Move the Economy (ESC) Switch to the OFF position.
- Only use the 12VDC receptacle to charge a 12 volt lead-acid type battery using an appropriate charge controller. (Battery and controller not included.) The 12VDC output is not regulated.
- Do not connect any device to the 12VDC terminal that draws more than 8 amps.
- If this 12VDC circuit protection is tripped, reduce the load, and press the Reset Button next to the outlet.

Note: Do not allow the Generator to completely run out of fuel with devices attached. A Generator's output may sharply spike as it runs out of fuel, causing damage to attached devices.

Connecting Electrical Loads

Familiarize yourself with the engine controls, power panel and how to start the engine before using the Generator. Calculate the wattage of the products you will use with the Generator and verify that the Generator can handle the total load.

⚠WARNING! Connect only properly wired plugs to the Generator. A plug that is spliced onto a different cord may be hazardous. Only a qualified electrician should wire a plug onto a cord.

⚠WARNING! Never exceed the rated capacity for this Generator, as serious damage to the Generator and/or appliances, tools, and equipment could result from an overload. Starting and running wattage requirements should always be calculated when matching this Generator's wattage capacity to the appliance, tool, or equipment.

Use the DC12V Receptacle to power 12VDC equipment.

⚠WARNING! TO PREVENT SERIOUS INJURY: Do not charge batteries without a proper charge controller. Do not overcharge.

- Connect the items that require the most wattage first.
- Connect "inductive" load appliances, tools, and equipment next. Inductive loads are small hand tools and some small appliances.
- Connect any lights next.
- Voltage sensitive appliances, tools, and equipment should be the last to be connected to the Generator. Plug voltage sensitive items such as TVs, DVD players, microwaves, and cordless telephones into a UL[®] Listed voltage surge protector (not included). Then, connect the surge protector into the Generator.

IMPORTANT! Failure to connect and operate appliances, tools, and equipment in this sequence can cause damage to the Generator, appliances, tools, and equipment and will **void** the Warranty of this Generator.

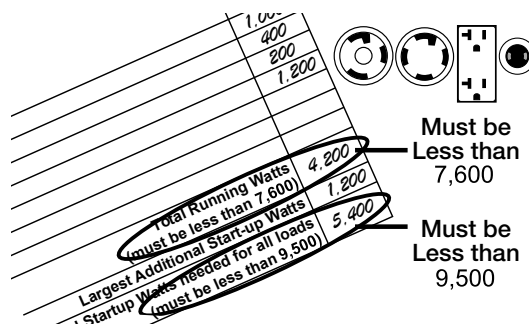

IF ANY CIRCUIT BREAKERS TRIP CHECK THE FOLLOWING:

1. Make sure that ALL circuit breakers are reset before starting the Generator again.
2. Adjust the plugs so the loads are shared across outlet circuits.

To achieve rated output from the Generator, distribute loads over outlets.

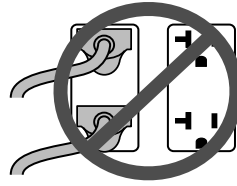

Evenly distributed over outlets:

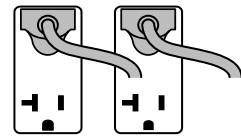

The generator uses a 2-circuit system to supply power to the receptacles. The loads must be evenly distributed across receptacles to prevent overload on a single circuit. If the loads being drawn are below the max rated wattage of the generator, yet the overload light begins blinking or the generator shuts off, try redistributing plugs across receptacles.

120V Only (3-wire) Adaptor Cord Connected to L14-30 Receptacle:

If the overload light begins blinking or the Generator shuts off, too much wattage is being drawn from one circuit even though the rated wattage of the Generator has not been reached. If an additional plug is connected to one of the duplex receptacles, move the plug to the other duplex receptacle. Restart the Generator.

Note: Only half the Generator's rated wattage, or 3800W, will be delivered through a 120V (3-wire) adaptor cord. Exceeding this may cause overload.

240V Cord Connected to L14-30 Receptacle:

The 240V cord will draw full wattage from both circuits. If further loads are possible, distribute them across receptacles.

Calculating Total Wattage of Devices Used with the Generator

Before using the Generator, check that the products you want to plug into the unit are below the rated and maximum wattage ratings of the Generator. Use the Wattage Calculation Table below, and the watts listed on your products, to help calculate multiple wattage totals.

To use the table:

1. Add up the Running Watts for all items you would like to use at any given time.
2. Make sure that this total is under the 7,600 running wattage of the Generator.
3. Find the single highest starting watts for the selected items and add to the total.
4. Make sure that this total is under the 9,500 max. starting wattage of the Generator.
5. Plug in and turn on products from largest wattage to smallest.

Wattage Calculation Table

| Equipment | Running Watts |
|---|---------------|
| | |
| | |
| | |
| | |
| | |
| | |
| | |
| | |
| | |
| Total Running Watts (must be less than 7,600) | |
| Largest Additional Start-up Watts | |
| Total Startup Watts needed for all loads (must be less than 9,500) | |

Example

| Equipment | Running Watts |
|---|---------------|
| <i>Electric Water Heater (2,000 + 0)</i> | <i>2,000</i> |
| <i>Television (400 + 0)</i> | <i>400</i> |
| <i>Lawn Mower (1,200 + 1,200)</i> | <i>1,200</i> |
| <i>Hand Drill (600 + 600)</i> | <i>600</i> |
| | |
| | |
| Total Running Watts (must be less than 7,600) | <i>4,200</i> |
| Largest Additional Start-up Watts | <i>1,200</i> |
| Total Startup Watts needed for all loads (must be less than 9,500) | <i>5,400</i> |

A generator that is rated more than the minimum required max. starting watts will last much longer than a generator that only supplies the exact watts needed.

To Calculate Wattage

Volts and amps can be multiplied together to get watts (volts x amps = watts).

To Calculate Additional Start-Up Watts (If They Are Not Listed)

For equipment with a motor: Use the rated watts amount as an estimate of additional Start-up Watts.

For most lights or heaters: there are no additional start-up watts.

Wattage Estimate Charts

Note: Wattages listed below are estimates for that type of equipment only. Check nameplate wattages on all loads before connecting to Generator.

| EMERGENCY | | |
|----------------------|---------------|---------------------------|
| Device | Running Watts | Additional Start-up Watts |
| Refrigerator/Freezer | 700 | 1500 |
| Radio | 100 | 0 |

| JOB SITE | | |
|-------------------------|---------------|---------------------------|
| Device | Running Watts | Additional Start-up Watts |
| Air Compressor - 1/2 HP | 1000 | 1000 |
| Table Saw - 10" | 1700 | 1300 |
| Belt Sander - 3" | 1200 | 1200 |
| Hand Drill - 1/2" | 600 | 600 |
| Halogen Work Light | 1000 | 0 |
| Reciprocating Saw | 900 | 900 |

| RECREATION | | |
|----------------|---------------|---------------------------|
| Device | Running Watts | Additional Start-up Watts |
| AM/FM Radio | 100 | 0 |
| Electric Grill | 1700 | 0 |
| Inflator Pump | 50 | 100 |
| CD/DVD Player | 100 | 0 |
| Box Fan - 20" | 200 | 200 |
| Coffee Maker | 600 | 0 |

| HOUSEHOLD | | |
|------------------------|---------------|---------------------------|
| Device | Running Watts | Additional Start-up Watts |
| Computer w/ Monitor | 800 | 0 |
| Electric Clothes Dryer | 5500 | 500 |
| Electric Range | 2100 | 0 |
| Electric Water Heater | 2000 | 0 |
| Light Bulb - 100 watts | 100 | 0 |
| Microwave - 1000 watts | 1000 | 200 |
| Sump Pump - 1/2 HP | 1000 | 1100 |
| Television | 400 | 0 |
| Washing Machine | 1100 | 1100 |
| Well Pump - 1/2 HP | 1000 | 1000 |

| LAWN & GARDEN | | |
|-----------------|---------------|---------------------------|
| Device | Running Watts | Additional Start-up Watts |
| Hedge Trimmer | 400 | 400 |
| Pressure Washer | 1200 | 1200 |
| Lawn Mower | 1200 | 1200 |
| Edger | 1000 | 1000 |

| HEATING & COOLING | | |
|-------------------------|---------------|---------------------------|
| Device | Running Watts | Additional Start-up Watts |
| Central AC - 10,000 BTU | 1500 | 1500 |
| Furnace Fan - 1/2 HP | 900 | 1400 |
| Space Heater | 1800 | 0 |
| Window AC - 10,000 BTU | 1200 | 600 |

Overload Indicator

Note: The OVERLOAD light may turn on for a few seconds as a large device starts up. This is normal for loads approaching the capacity of this Generator.

1. The total combined load through the outlets on the Generator must not exceed the running power of the unit.
2. The OVERLOAD light will begin blinking if the generator is approaching overload limit. If the OVERLOAD light stays on and the Generator stops producing power, the generator has been overloaded.
3. Turn off and disconnect all electrical devices and stop the Engine. Compare device requirements to Generator rating and reduce the total wattage of connected devices if necessary. Move anything that may be limiting Generator ventilation away.
4. Check if any circuit breakers have tripped and make sure that ALL circuit breakers are reset before starting the Generator again.
5. Restart the Engine and reconnect devices while being careful to not overload Generator.
6. Distribute loads evenly across receptacles to achieve rated output.

Low Oil Indicator

1. If the Engine oil level is too low, the LOW OIL light turns on and the Engine will automatically shut off.
2. The Engine cannot be restarted until the proper amount of oil has been added. Add the appropriate type of oil until the oil level is at the proper level. SAE 10W-30 oil is recommended for general use.

NOTICE: Do not run the engine with too little oil. Engine will shut off if engine oil level is too low.

Note: The LOW OIL light will blink if the Generator stops due to CO sensor shutoff. This does not indicate low oil. Follow all instructions under Carbon Monoxide Shutoff on page 12.

Economy (ESC) Switch

1. Turn the Economy (ESC) Switch ON to limit noise and fuel consumption for lighter generator loads.
2. Turn the Economy (ESC) Switch OFF to operate engine at full speed:
 - a. when starting
 - b. when a heavy load is applied
 - c. when using the 12VDC output

Hour Meter

The Hour Meter shows cumulative run time in hours.

Voltage Selector

The Voltage Selector allows more current to be available at 120V outlets if 240V output is not required:

- Place switch at 120V only - only 120V outlets can be used.
- Place switch at 120/240V: Both 120V and 240V outlets can be used.

NOTE: Do not change the switch while under load.

For parallel function, Switch position must be at 120/240V.

Circuit Breakers

The circuit breaker protects the Generator from overloading. The rating of the breaker and the load it protects are marked near the breaker. Should any of the Circuit Breakers trip, the Generator will stop the electricity output. If this happens, unplug all loads from the Generator. Then, turn the tripped Circuit Breaker to ON and re-attach loads gradually. Note: For push-type Circuit Breakers allow a few minutes for cool-down before restarting.



Stopping the Engine

To stop the Engine in an emergency, turn the Engine Switch OFF.

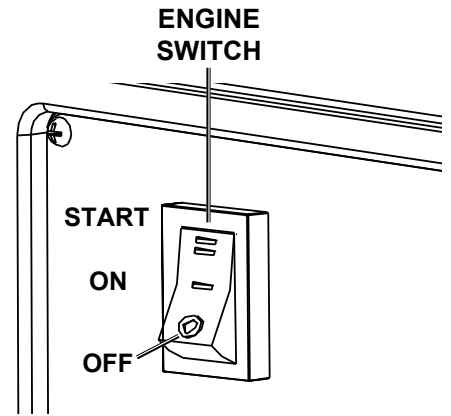

Under normal conditions, use the following procedure to shut off the Generator:

1. Turn all electrical load devices off and unplug them from the Generator. If the Economy Switch is ON, turn it to the OFF position.

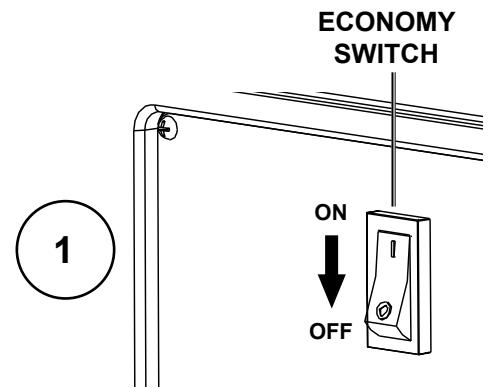

2. Turn the Combination Switch OFF.

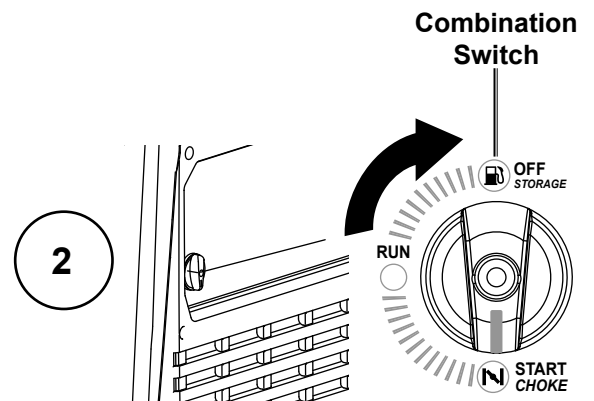

3. After engine stops, turn Engine Switch to OFF.

⚠WARNING

TO PREVENT SERIOUS INJURY FROM ACCIDENTAL STARTING:

Turn the Combination Switch of the equipment to its "OFF" position, wait for the engine to cool, and disconnect the spark plug cap before performing any inspection, maintenance, or cleaning procedures.

TO PREVENT SERIOUS INJURY FROM EQUIPMENT FAILURE:

Do not use damaged equipment. If abnormal noise, vibration, or excess smoking occurs, have the problem corrected before further use.

Follow all service instructions in this manual. The engine may fail critically if not serviced properly.



Many maintenance procedures, including any not detailed in this manual, will need to be performed by a qualified technician for safety. If you have any doubts about your ability to safely service the equipment or engine, have a qualified technician service the equipment instead.

Cleaning, Maintenance, and Lubrication Schedule

Note: This maintenance schedule is intended solely as a general guide. If performance decreases or if equipment operates unusually, check systems immediately. The maintenance needs of each piece of equipment will differ depending on factors such as duty cycle, temperature, air quality, fuel quality, and other factors.

Note: The following procedures are in addition to the regular checks and maintenance explained as part of the regular operation of the engine and equipment.

| Procedure | Before Each Use | Monthly or every 8 hr. of use | Every 3 mo. or 50 hr. of use | Every 6 mo. or 100 hr. of use | Yearly or every 300 hr. of use | Every 2 Years | Page |
|--|-----------------|-------------------------------|------------------------------|-------------------------------|--------------------------------|---------------|------|
| 1. Brush off outside of engine 2. Check engine oil level 3. Check air filter | ✓ | | | | | | |
| Change engine oil | | | | ✓ | | | 19 |
| Clean/replace air cleaner | | | ✓* | | | | 20 |
| 1. Check and clean spark plug 2. Check and clean spark arrestor | | | | ✓ | | | 20 |
| 1. Check/adjust idle speed 2. Check/adjust valve clearance 3. Clean fuel tank, strainer and carburetor 4. Clean carbon build-up from combustion chamber | | | | | ✓** | | - |
| Replace fuel line if necessary | | | | | | ✓** | - |

*Service more frequently when used in dusty areas.

**These items should be serviced by a qualified technician.

Checking and Filling Fuel



⚠️WARNING! TO PREVENT SERIOUS INJURY FROM FIRE:

Fill the fuel tank in a well-ventilated area away from ignition sources. If the engine is hot from use, shut the engine off and wait for it to cool before adding fuel. Do not smoke.

1. Clean the Fuel Cap and the area around it.
2. Unscrew and remove the Fuel Cap.
3. Remove the Strainer and remove any dirt and debris. Then replace the Strainer.

Note: Do not use gasoline containing more than 10% ethanol (E10). Do not use E85 ethanol. Add fuel stabilizer to the gasoline or the Warranty is VOID.

Engine Oil Change

⚠️CAUTION! Oil is very hot during operation and can cause burns. Wait for engine to cool before changing oil.

1. Make sure the Engine is stopped and is level.
2. On the right side of the Generator, loosen the Screws and remove the Oil Fill Access Door, as shown to the right.
3. Remove the lower Rubber Seal from underneath the Generator. See below.

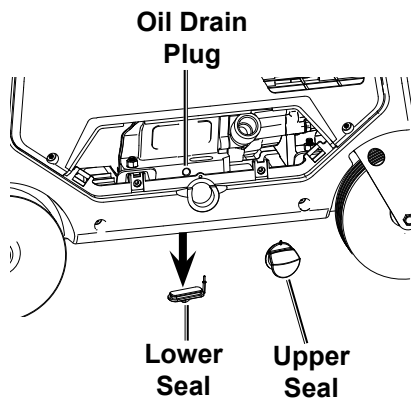

4. Place an oil drain pan under the Generator and center under the Oil Drain Hose opening. Remove the Oil Drain Cap, tilt the Generator slightly to facilitate drainage and wait for oil to drain completely. Recycle used oil.
5. Clean the top of the Oil Fill Cap/Dipstick and the area around it. Remove the Cap/Dipstick, turning it counterclockwise.
6. Remove the upper Rubber Seal from just below the Oil Drain Plug.
7. Use a wrench (sold separately) to remove the Oil Drain Plug and allow the oil to drain completely.
8. Replace the Oil Drain Cap. Put the Oil Drain Hose back into the Generator.
9. Add the appropriate type of oil until the oil level is at the proper level. SAE 10W-30 oil is recommended for general use.

Note: Make sure Generator is level when adding oil to prevent overfilling which could cause engine damage.

Note: Do not use gasoline that has been stored in a metal fuel container or a dirty fuel container. It can cause particles to enter the carburetor, affecting engine performance and/or causing damage.

4. If needed, fill the Fuel Tank to about 1 inch under the fill neck of the Fuel Tank with 87 octane or higher unleaded gasoline that has been treated with a fuel stabilizer additive. Follow fuel stabilizer manufacturer's recommendations for use.
5. Replace the Fuel Cap.
6. Wipe up any spilled fuel and allow excess to evaporate before starting engine. To prevent FIRE, do not start the engine while the smell of fuel hangs in the air.

10. Check the oil level. The oil level should be up to the edge of the hole as shown.
11. Thread the Oil Fill Cap/Dipstick back in clockwise and replace the Oil Fill Access Door.

NOTICE: Do not run the engine with too little oil. Engine will not start with low or no engine oil.

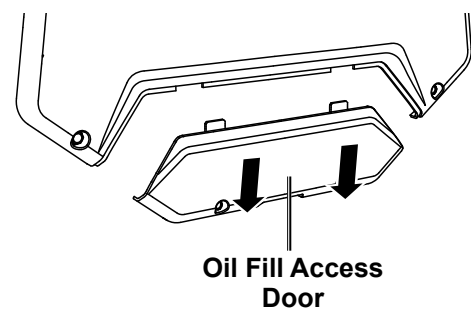
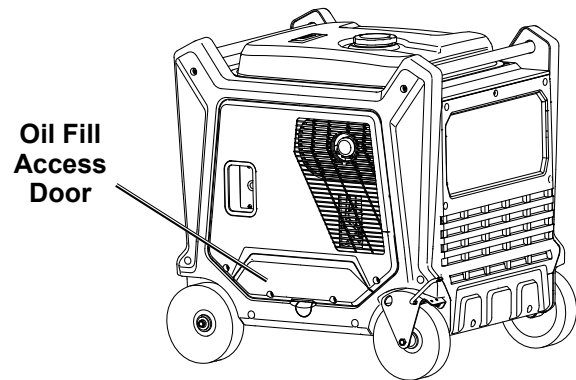

Air Filter Element Maintenance

1. Loosen screws and remove the Air Filter Access Panel on the left side of the Generator.

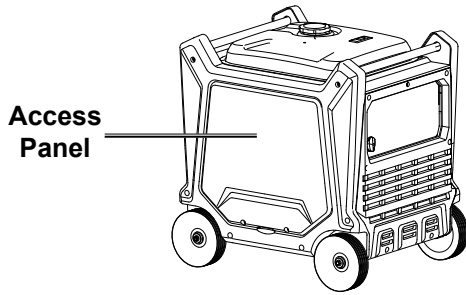

2. Unsnap the Air Filter Cover Clip and remove Air Filter Cover. See figure below.
3. Remove Air Filter.

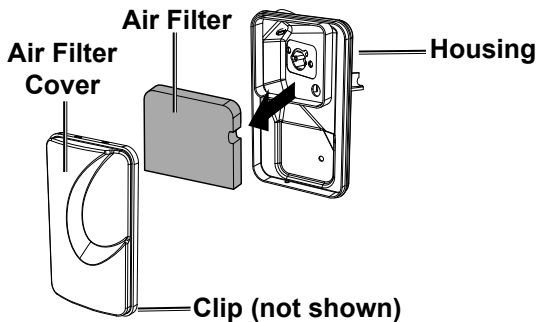

4. **Cleaning:**

- For “paper” filter elements:
To prevent injury from dust and debris, wear ANSI-approved safety goggles, NIOSH-approved dust mask/respirator, and heavy-duty work gloves. In a well-ventilated area away from bystanders, use pressurized air to blow dust out of the air filter.
- For foam filter elements:
Wash the element in warm water and mild detergent several times. Rinse. Squeeze out excess water and allow it to dry completely. Soak the filter in lightweight oil briefly, then squeeze out the excess oil.

5. Install the cleaned filter.
6. Secure the Air Filter Cover and replace the Access Panel before use.

Spark Arrestor Maintenance

⚠️ WARNING

TO PREVENT SERIOUS INJURY AND FIRE: Operate only with proper spark arrestor installed.



Operation of this equipment may create sparks that can start fires around dry vegetation. A spark arrestor may be required. The operator should contact local fire agencies for laws or regulations relating to fire prevention requirements.

1. Allow the Generator to cool completely.
2. Remove the Screws from the back of the Generator.
3. Remove the Tail Pipe and Spark Arrestor.
4. Clean the Spark Arrestor using a wire brush (sold separately). Replace arrestor if damaged.

5. **WARNING! TO PREVENT SERIOUS INJURY FROM ACCIDENTAL BRUSH FIRE, secure Spark Arrestor back in place immediately after cleaning and before further operation.**

Spark Plug Maintenance

1. Loosen two screws and remove the Access Panel on the left side of the Generator.

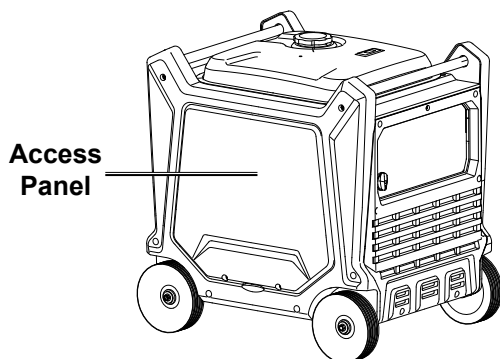

2. Disconnect Spark Plug Cap from end of plug. Clean out debris from around Spark Plug.

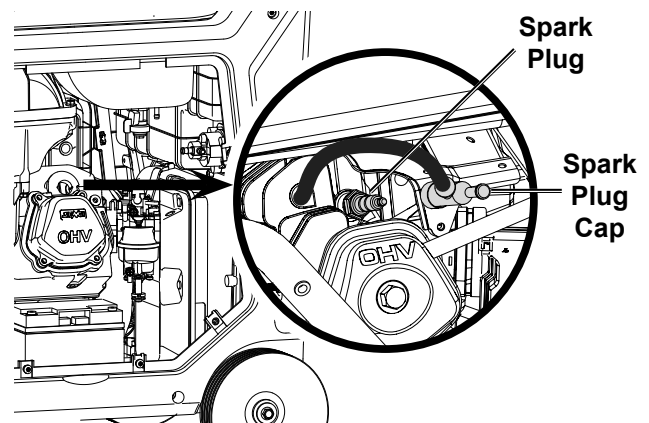

3. Using the Spark Plug Wrench, remove the Spark Plug.
4. Inspect the Spark Plug:
If the electrode is oily, clean it using a clean, dry rag. If the electrode has deposits on it, polish it using emery paper. If the white insulator is cracked or chipped, the spark plug needs to be replaced.

NOTICE: Use only BPR6ES (NGK) type spark plug or equivalent. Using an incorrect spark plug may damage the engine.

5. When installing a new spark plug, adjust the plug's gap to the specification on the Specifications chart. Do not pry against the electrode, the spark plug can be damaged.
6. Apply anti-seize material to Spark Plug threads. Install the new spark plug or the cleaned spark plug into the engine.

- **Gasket-style:**
Finger-tighten until the gasket contacts the cylinder head, then tighten about 1/2-2/3 turn more.
- **Non-gasket-style:**
Finger-tighten until the plug contacts the cylinder head, then tighten about 1/16 turn more.

NOTICE: Tighten the Spark Plug properly.

If loose, the Spark Plug will cause the engine to overheat.

If overtightened, the threads in the engine block will be damaged.

7. Apply dielectric spark plug boot protector (not included) to the end of the spark plug and reattach the cap securely.
8. Replace Spark Plug Access Cover and Access Panel.

Storage

When the equipment is to remain idle for longer than 20 days, prepare the engine for storage as follows:

1. **CLEANING:**

Wait for engine to cool, then clean engine with dry cloth. **NOTICE: Do not clean using water.** The water will gradually enter the engine and cause damage.

2. **FUEL:**

Gasoline Treatment/Draining the Fuel Tank

To protect the fuel tank during storage, fill the tank with fresh gasoline that has been treated with a fuel stabilizer additive. Follow fuel stabilizer manufacturer's recommendations for use. Refer to Checking and Filling Fuel Checking and Filling Fuel on page 11.

Aged gasoline that has not been treated with stabilizer ahead of time must be safely drained away and not run through the engine.



▲WARNING! TO PREVENT SERIOUS INJURY FROM FIRE:

Fill tank in a well-ventilated area away from ignition sources. If the engine is hot from use, shut the engine off and wait for it to cool before adding fuel. Do not smoke.

Draining the Carburetor

After closing the Fuel Valve, place an appropriate container under the Carburetor and carefully remove the Drain Bolt from the bottom of the Carburetor Bowl, allowing the fuel to drain completely. Replace the Drain Bolt after draining.

WARNING! To prevent serious injury and fire, close the Fuel Valve before draining the Carburetor.

3. **LUBRICATION:**

- a. Change engine oil.
- b. Clean out area around spark plug.
Remove spark plug and pour one tablespoon of engine oil into cylinder through spark plug hole.
- c. Replace spark plug, but leave spark plug cap disconnected.
- d. Pull Starter Handle to distribute oil in cylinder. Stop after one or two revolutions when you feel the piston start the compression stroke (when you start to feel resistance).

4. **STORAGE AREA:**

Cover and store in a dry, level, well-ventilated area out of reach of children. Storage area should also be away from ignition sources, such as water heaters, clothes dryers, and furnaces. Avoid direct exposure to rain and sunlight.

NOTICE: During extended storage periods the Engine must be started every 3 months and allowed to run for 15–20 minutes or the Warranty is VOID.

5. **AFTER STORAGE:**

Before starting the engine after storage, keep in mind that untreated gasoline will deteriorate quickly. Drain the fuel tank and change to fresh fuel if untreated gasoline has been sitting for a month, if treated gasoline has been sitting beyond the fuel stabilizer's recommended time period, or if the engine does not start.

Troubleshooting

SAFETY

SETUP

OPERATION

MAINTENANCE

| Problem | Possible Causes | Probable Solutions |
|-----------------------|---|---|
| Engine will not start | FUEL RELATED: <ol style="list-style-type: none"> No fuel in tank or fuel valve closed. Combination Switch not in START position, cold engine. Gasoline with more than 10% ethanol used. (E15, E20, E85, etc.) Low quality or deteriorated, old gasoline. Carburetor not primed. Dirty fuel passageways. Carburetor needle stuck. Fuel can be smelled in the air. Too much fuel in chamber. This can be caused by the carburetor needle sticking. Clogged Fuel Filter. | FUEL RELATED: <ol style="list-style-type: none"> Fill fuel tank with fresh 87+ octane stabilizer-treated unleaded gasoline and open fuel valve. Do not use gasoline with more than 10% ethanol (E15, E20, E85, etc.). Move Combination Switch to START position. Clean out ethanol rich gasoline from fuel system. Replace components damaged by ethanol. Use fresh 87+ octane stabilizer-treated unleaded gasoline only. Do not use gasoline with more than 10% ethanol (E15, E20, E85, etc.). Use fresh 87+ octane stabilizer-treated unleaded gasoline. Do not use gasoline with more than 10% ethanol (E15, E20, E85, etc.). Pull on Starter Handle to prime. Clean out passageways using fuel additive. Heavy deposits may require further cleaning. Gently tap side of carburetor float chamber with screwdriver handle. Turn Choke to RUN position. Remove spark plug and pull the start handle several times to air out the chamber. Reinstall spark plug and set Choke to START position. Replace Fuel Filter. |
| | IGNITION (SPARK) RELATED: <ol style="list-style-type: none"> Engine Switch at OFF position. Spark plug cap not connected securely. Spark plug electrode wet or dirty. Incorrect spark plug gap. Spark plug cap broken. Circuit breaker tripped (electric start models only). Incorrect spark timing or faulty ignition system. | IGNITION (SPARK) RELATED: <ol style="list-style-type: none"> Turn Engine Switch to ON. Connect spark plug cap properly. Clean spark plug. Correct spark plug gap. Replace spark plug cap. Reset circuit breaker. Check wiring and starter motor if breaker continues to trip. Have qualified technician diagnose/repair ignition system. |
| | COMPRESSION RELATED: <ol style="list-style-type: none"> Cylinder not lubricated. Problem after long storage periods. Loose or broken spark plug. (Hissing noise will occur when trying to start.) Loose cylinder head or damaged head gasket. (Hissing noise will occur when trying to start.) Engine valves or tappets mis-adjusted or stuck. | COMPRESSION RELATED: <ol style="list-style-type: none"> Pour tablespoon of oil into spark plug hole. Crank engine a few times and try to start again. Tighten spark plug. If that does not work, replace spark plug. If problem persists, may have head gasket problem, see #3. Tighten head. If that does not remedy problem, replace head gasket. Have qualified technician adjust/repair valves and tappets. |
| | ENGINE OIL RELATED: <ol style="list-style-type: none"> Low engine oil. Engine mounted on slope, triggering low oil shutdown. | ENGINE OIL RELATED: <ol style="list-style-type: none"> Fill engine oil to proper level. Check engine oil before EVERY use. Operate engine on level surface. Check engine oil level. |
| | SPARK ARRESTOR RELATED: <ol style="list-style-type: none"> Spark Arrestor clogged with soot. | SPARK ARRESTOR RELATED: <ol style="list-style-type: none"> Clean and replace Spark Arrestor. |



Follow all safety precautions whenever diagnosing or servicing the generator or engine.

| Problem | Possible Causes | Probable Solutions |
|------------------------------------|--|---|
| Engine will not start (continued) | ELECTRIC START RELATED: 1. No battery or defective battery installed. 2. Battery is low. 3. Electric start fuse (5A) is blown. | ELECTRIC START RELATED: 1. Install a new battery (see page 8). 2. Charge the battery. 3. Replace fuse with similar size fuse. |
| Engine misfires | 1. Spark plug cap loose. 2. Incorrect spark plug gap or damaged spark plug. 3. Defective spark plug cap. 4. Old or low quality gasoline. 5. Incorrect compression. | 1. Check cap and wire connections. 2. Re-gap or replace spark plug. 3. Replace spark plug cap. 4. Use only fresh 87+ octane stabilizer-treated unleaded gasoline. Do not use gasoline with more than 10% ethanol (E15, E20, E85, etc.). 5. Diagnose and repair compression. (Use Engine will not start: COMPRESSION RELATED section.) |
| Engine stops suddenly | 1. Carbon Monoxide level high. Red light on Carbon Monoxide Sensor illuminates. 2. CO Sensor Alarm flashes yellow continually shortly after starting. 3. CO Sensor Alarm flashes yellow continually after longer period of operation. 4. Low oil shutdown. 5. Fuel tank empty or full of impure or low quality gasoline. 6. Combination Switch at OFF/ Storage position. 7. Defective fuel tank cap creating vacuum, preventing proper fuel flow. 8. Faulty magneto. 9. Disconnected or improperly connected spark plug cap. | 1. Leave area immediately and allow area to ventilate thoroughly. Only operate generator outside. 2. Carbon monoxide sensor malfunction. Sensor needs service. Call 1-888-866-5797 as soon as possible. Do not use the Generator until the sensor is working properly. 3. Make sure to operate generator within rated ambient temperature; maintain minimum 5 ft. clearance from all sides. 4. Fill engine oil to proper level. Check engine oil before EVERY use. 5. Fill fuel tank with fresh 87+ octane stabilizer treated unleaded gasoline. Do not use gasoline with more than 10% ethanol (E15, E20, E85, etc.). 6. Turn Combination Switch to RUN position. 7. Test/replace fuel tank cap. 8. Have qualified technician service magneto. 9. Secure spark plug cap. |
| Engine stops when under heavy load | 1. Dirty air filter 2. Engine running cold. | 1. Clean element. 2. Allow engine to warm up prior to operating equipment. |
| Engine knocks | 1. Old or low quality gasoline. 2. Engine overloaded. 3. Incorrect spark timing, deposit buildup, worn engine, or other mechanical problems. | 1. Fill fuel tank with fresh 87+ octane stabilizer-treated unleaded gasoline. Do not use gasoline with more than 10% ethanol (E15, E20, E85, etc.). 2. Do not exceed equipment's load rating. 3. Have qualified technician diagnose and service engine. |
| Engine backfires | 1. Impure or low quality gasoline. 2. Engine too cold. 3. Intake valve stuck or overheated engine. 4. Incorrect timing. | 1. Fill fuel tank with fresh 87+ octane stabilizer-treated unleaded gasoline. Do not use gasoline with more than 10% ethanol (E15, E20, E85, etc.). 2. Use cold weather fuel and oil additives to prevent backfiring. 3. Have qualified technician diagnose and service engine. 4. Check engine timing. |
| Attached device doesn't have power | 1. Device not plugged in properly. 2. Circuit Breaker tripped. 3. Product needs service. | 1. Turn off and unplug the device, then plug it back in again and turn on. 2. Turn off and unplug device, reset Circuit Breaker, plug in device and turn on. 3. Have product repaired. |



Follow all safety precautions whenever diagnosing or servicing the generator or engine.

Troubleshooting (continued)

| Problem | Possible Causes | Probable Solutions |
|--|--|---|
| Attached device begins to operate abnormally | <ol style="list-style-type: none"><li data-bbox="379 226 794 259">1. Problem with device.<li data-bbox="379 315 794 349">2. Rated load capacity exceeded. | <ol style="list-style-type: none"><li data-bbox="874 226 1492 304">1. Immediately unplug device. Have device repaired by a qualified technician, or replace device.<li data-bbox="874 315 1492 394">2. Lower the number of items plugged into the generator to stay within the rated capacity, or use a more powerful generator. |



Follow all safety precautions whenever diagnosing or servicing the generator or engine.

PLEASE READ THE FOLLOWING CAREFULLY

THE MANUFACTURER AND/OR DISTRIBUTOR HAS PROVIDED THE PARTS LISTS AND ASSEMBLY DIAGRAMS IN THIS MANUAL AS A REFERENCE TOOL ONLY. NEITHER THE MANUFACTURER OR DISTRIBUTOR MAKES ANY REPRESENTATION OR WARRANTY OF ANY KIND TO THE BUYER THAT HE OR SHE IS QUALIFIED TO MAKE ANY REPAIRS TO THE PRODUCT, OR THAT HE OR SHE IS QUALIFIED TO REPLACE ANY PARTS OF THE PRODUCT. IN FACT, THE MANUFACTURER AND/OR DISTRIBUTOR EXPRESSLY STATES THAT ALL REPAIRS AND PARTS REPLACEMENTS SHOULD BE UNDERTAKEN BY CERTIFIED AND LICENSED TECHNICIANS, AND NOT BY THE BUYER. THE BUYER ASSUMES ALL RISK AND LIABILITY ARISING OUT OF HIS OR HER REPAIRS TO THE ORIGINAL PRODUCT OR REPLACEMENT PARTS THERETO, OR ARISING OUT OF HIS OR HER INSTALLATION OF REPLACEMENT PARTS THERETO.

SAFETY

SETUP

OPERATION

MAINTENANCE

Record Product's Serial Number Here: _____

Note: If product has no serial number, record month and year of purchase instead.

Note: Some parts are listed and shown for illustration purposes only, and are not available individually as replacement parts. Specify UPC 193175546340 when ordering parts.

Parts List and Diagram

Parts List - Generator

SAFETY

SETUP

OPERATION

MAINTENANCE

| Part | Description | Qty |
|------|---------------------------------------|-----|
| 1 | Engine | 1 |
| 2 | Hex Flange Nut | 4 |
| 3 | Damping Bearing A | 3 |
| 4 | Damping Bearing B | 1 |
| 5 | Plug | 1 |
| 6 | Inverter Shock Pad | 2 |
| 7 | Backplane Assembly | 1 |
| 8 | Support Components | 1 |
| 9 | Hex Flange Nut | 21 |
| 10 | Brake Parts | 2 |
| 11 | Hex Flange Bolt | 4 |
| 12 | Hex Flange Bolt | 18 |
| 13 | Flat Washer | 4 |
| 14 | Bush | 2 |
| 15 | Wheel Shaft | 2 |
| 16 | Wheel Assy | 4 |
| 17 | Muffler Housing | 1 |
| 18 | Under Cover Plate Of Muffler | 1 |
| 19 | Hex Flange Nut | 11 |
| 20 | Hex Flange Nut | 1 |
| 21 | Hex Flange Nut | 4 |
| 22 | Muffler | 1 |
| 23 | Muffler Exhaust Hood A | 1 |
| 24 | Hex Flange Bolt | 4 |
| 25 | Exhaust Valve Spring Lower Seat | 1 |
| 26 | The Push Rod Guide | 10 |
| 27 | Alternator Exhaust Hood | 1 |
| 28 | Support | 2 |
| 29 | Support | 2 |
| 30 | Rack Right Beam | 2 |
| 31 | Front And Rear Top Beam | 2 |
| 32 | Front And Bottom Beam | 1 |
| 33 | Hex Flange Bolt | 14 |
| 34 | Battery | 1 |
| 35 | Battery Box | 1 |
| 36 | Control Panel | 1 |
| 37 | Hex Flange Bolt | 4 |
| 38 | Air Guide Hood Assembly | 1 |
| 39 | Inverter Left Bracket | 1 |
| 40 | Inverter Right Bracket | 1 |
| 41 | Inverter | 1 |
| 42 | Hex Flange Nut | 5 |
| 43 | Fuel Tank Assy | 1 |
| 44 | Fuel Tank Heat Insulation Cotton Assy | 1 |
| 45 | Self Tapping Screw | 12 |
| 46 | Upper Cover Assembly | 2 |
| 47 | Handle Pipe Assembly | 1 |
| 48 | Handle Pipe Assembly | 1 |
| 49 | Hex Flange Bolts | 43 |
| 50 | Right Plate | 2 |
| 51 | Plug | 2 |
| 52 | Right Side Window Panel Assembly | 1 |

| Part | Description | Qty |
|------|--------------------------------------|-----|
| 53 | Right Side Window Oil Plate Assembly | 1 |
| 54 | Left Side Window Panel Assembly | 1 |
| 55 | Alternator Cover Plate Assembly | 1 |
| 56 | Inverter Cover Panel Assembly | 1 |
| 57 | Hand The Glue Sets | 2 |
| 58 | Hand The Glue Sets | 1 |
| 59 | Clamp | 2 |
| 60 | Clamp | 5 |
| 61 | Fuel Pipe | 1 |
| 62 | Filter Mesh Assembly | 1 |
| 63 | Flat Washer | 10 |
| 64 | Flat Washer | 4 |
| 65 | Hex Flange Nut | 2 |
| 66 | Spring Washer | 2 |
| 67 | Muffler Gasket | 2 |
| 68 | Battery Band | 1 |
| 69 | Wire Harness | 1 |
| 70 | Wire Harness | 1 |
| 71 | Clip Nut | 16 |
| 72 | Wiring Harness Parts | 1 |
| 73 | Stabilizer Module Bracket | 1 |
| 74 | Hex Flange Bolts | 2 |
| 75 | Dc Stabilizer | 1 |
| 76 | Handle Fixing Seat | 1 |
| 77 | Handle Fixing Seat | 1 |
| 78 | Movable Pin | 1 |
| 79 | Tighten The Spring | 1 |
| 80 | Shake Hands handle Components | 1 |
| 81 | Hex Flange Nut | 1 |
| 82 | Handle Pipe Assembly | 1 |
| 83 | Hex Flange Nut | 2 |
| 84 | Handle Retaining Pin | 2 |
| 85 | Hex Flange Bolt | 4 |
| 86 | Nylon Nut | 4 |
| 87 | Hand The Glue Sets | 1 |
| 88 | Charger Module | 1 |
| 89 | Carbon Canister | 1 |
| 90 | Carbon Tank Pressure Plate A | 1 |
| 91 | Carbon Tank Pressure Plate B | 1 |
| 92 | Carbon Tank Bracket | 1 |
| 93 | Breather Pipe | 1 |
| 94 | Breather Pipe | 1 |
| 95 | CO Sensor | 1 |
| 96 | CO Sensor Support | 1 |
| 97 | Anti-Theft Bolt 12/8.8 | 4 |
| 98 | Anti-Theft Bolt 10/8.8 | 2 |
| 99 | Wire Harness | 1 |
| 100 | Plug | 4 |
| 101 | Insulation Sleeve | 2 |
| 102 | Rubber Plug | 2 |
| 103 | Air Filter Support | 1 |

Assembly Diagram - Generator

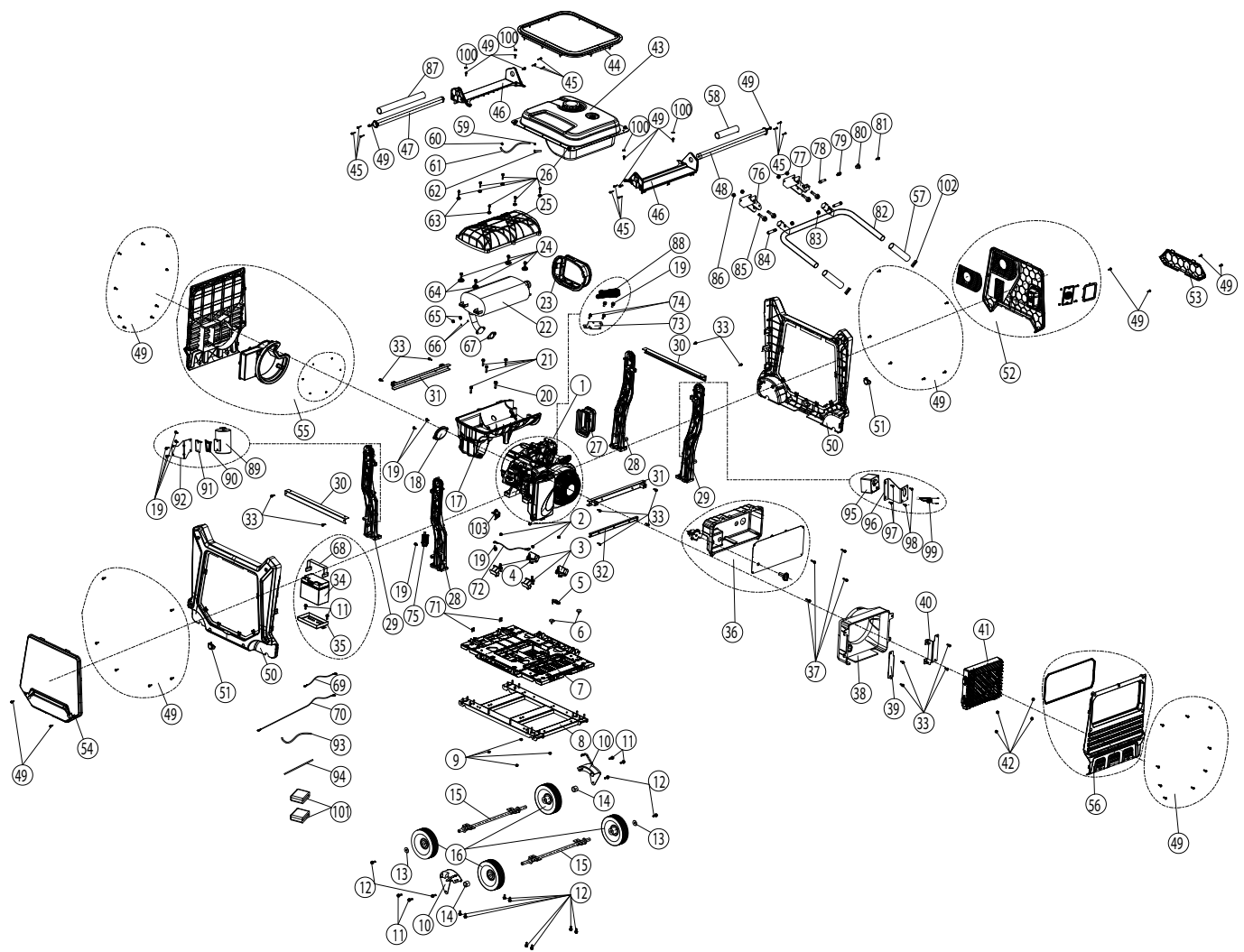

SAFETY

SETUP

OPERATION

MAINTENANCE

Parts List A - Engine

SAFETY

SETUP

OPERATION

MAINTENANCE

| Part | Description | Qty |
|------|---------------------------------|-----|
| 1A | Hex Flange Bolt M6*1 | 8 |
| 2A | Cylinder Head Assembly | 1 |
| 3A | Cylinder Head Gasket | 1 |
| 4A | Clamp Ø14xØ15.5x10 | 1 |
| 5A | Waste Pipe | 1 |
| 6A | Nut M6-0.75 | 2 |
| 7A | Rocker Shaft | 2 |
| 8A | Rocker Arm | 2 |
| 9A | Rocker Shaft Bolt | 2 |
| 10A | Exhaust Valve Rotor | 2 |
| 11A | Exhaust Valve Spring Seat | 2 |
| 12A | Spring, Valve | 2 |
| 13A | Exhaust Valve Spring Lower Seat | 2 |
| 14A | Oil Seal | 2 |
| 15A | Push Rod Guide | 1 |
| 16A | Cylinder Head | 1 |
| 17A | Hex Flange Bolt M10x1.25 | 4 |
| 18A | Spark Plug Component | 1 |
| 19A | Bolt,Stud,Exhaust | 2 |
| 20A | Bolt,Stud,Inlet | 2 |
| 21A | Spark Plug Rubber Cover | 1 |
| 22A | Hex Flange Bolt M6x1 | 14 |
| 23A | Shroud | 1 |
| 24A | Air Inlet Gasket | 1 |
| 25A | Carburetor Connector Block | 1 |
| 26A | Carburetor Washer | 1 |
| 27A | Carburetor | 1 |
| 28A | Wire Clamp | 1 |
| 29A | Clamp | 1 |
| 30A | Tube, Fuel | 1 |
| 31A | Wire Clamp | 1 |
| 32A | Tubing Sleeve | 1 |
| 33A | Gasket, Air Cleaner | 2 |
| 34A | Carburetor Cable Support | 1 |
| 35A | Air Filter | 1 |
| 36A | Cylinder Head Gasket | 1 |
| 37A | Locating Pin Ø10x12x20 | 2 |
| 38A | Push Rod | 2 |
| 39A | Valve, Intake | 1 |
| 40A | Valve, Exhaust | 1 |
| 41A | Lifter, Valve | 2 |
| 42A | Ring Set, Piston | 1 |
| 43A | Clip, Piston Pin | 2 |
| 44A | Piston | 1 |
| 45A | Piston Pin Ø15x20x62 | 1 |
| 46A | Connecting Rod Assy | 1 |
| 47A | Hex Flange Bolt M12x1.5 | 2 |

| Part | Description | Qty |
|------|---------------------------------------|-----|
| 48A | Aluminum Washer | 2 |
| 49A | Crankcase | 1 |
| 50A | Metal Clip | 1 |
| 51A | Oil Alert | 1 |
| 52A | Speed Governor | 1 |
| 53A | Metal Clip | 1 |
| 54A | Oil Seal | 2 |
| 55A | Coil Assy, Ignition | 1 |
| 56A | Hex Flange Bolt M8x1.25 | 2 |
| 57A | Flywheel Part | 1 |
| 58A | Charging Coil Unit | 1 |
| 59A | Hex Flange Bolt M6x1 | 2 |
| 60A | Wire Press Plate | 1 |
| 61A | Fan | 1 |
| 62A | Pulley, Starter | 1 |
| 63A | Hex Flange Nut M16x1.5 | 1 |
| 64A | Recoil Starter Assembly | 1 |
| 65A | Deep Groove Ball Bearing | 2 |
| 66A | Hex Flange Bolt M6x1 | 2 |
| 67A | Engine Oil Sensor | 1 |
| 68A | Balance Shaft | 1 |
| 69A | Camshaft | 1 |
| 70A | Crankshaft | 1 |
| 71A | Cylinder Head Air Guide Sealing Strip | 1 |
| 72A | Clamp Part | 1 |
| 73A | Cross Recessed Countersunk Screw | 4 |
| 74A | Clamp Part | 1 |
| 75A | Cylinder Head Air Guide Sealing Strip | 1 |
| 76A | Crankcase Cover | 1 |
| 77A | Hex Flange Bolt M8x1.25 | 17 |
| 78A | Crankcase Cover Baffle | 1 |
| 79A | Oil Gauge Assembly | 1 |
| 80A | Deep Groove Ball Bearing | 1 |
| 81A | Dowel Pin | 4 |
| 82A | Crankcase Cover Gasket | 1 |
| 83A | Hex Flange Bolt M6x1 | 2 |
| 84A | Starting Motor | 1 |
| 85A | Nut With Flange M6x1.0 | 2 |
| 86A | Fan | 1 |
| 87A | Inverter Rotor | 1 |
| 88A | Flat Washer Ø18.5xØ36.5x5 | 1 |
| 89A | Nut With Flange M18x1.5 | 1 |
| 90A | Hex Socket Cap Screw M8x1.25 | 4 |
| 91A | Invertor Stator | 1 |
| 92A | Locating Pin | 4 |
| 93A | End cover | 1 |
| 94A | Alternator Cover Plug | 1 |

When ordering replacement parts from this list, the "A" suffix must be included in order to receive the correct part.

Assembly Diagram A - Engine

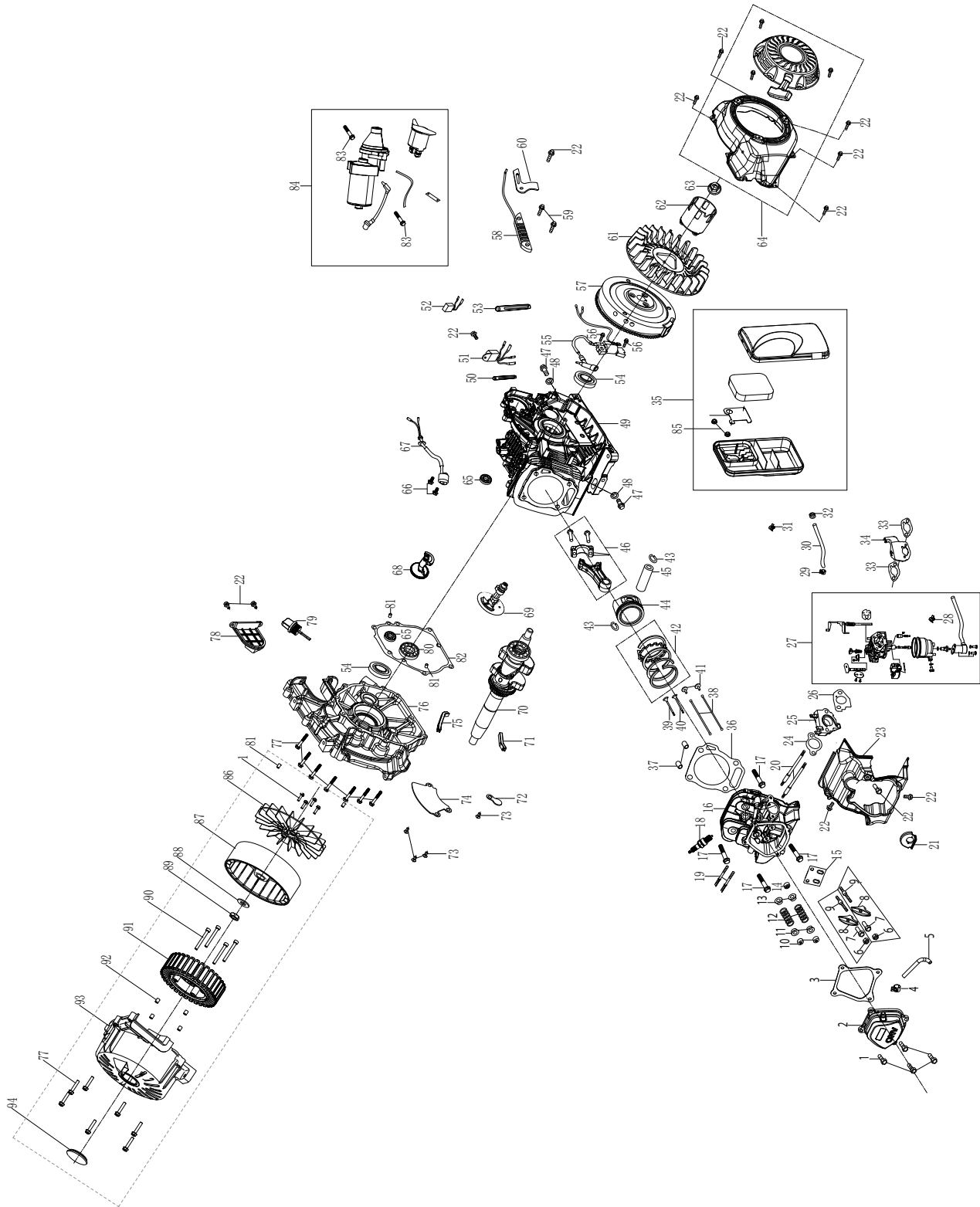

SAFETY

SETUP

OPERATION

MAINTENANCE

Limited 90 Day Warranty (Retail)

SAFETY

Harbor Freight Tools Co. makes every effort to assure that its products meet high quality and durability standards, and warrants to the original purchaser that this product is free from defects in materials and workmanship for the period of 90 days from the date of purchase. This warranty does not apply to damage due directly or indirectly, to misuse, abuse, negligence or accidents, repairs or alterations outside our facilities, criminal activity, improper installation, normal wear and tear, or to lack of maintenance. We shall in no event be liable for death, injuries to persons or property, or for incidental, contingent, special or consequential damages arising from the use of our product. Some states do not allow the exclusion or limitation of incidental or consequential damages, so the above limitation of exclusion may not apply to you. THIS WARRANTY IS EXPRESSLY IN LIEU OF ALL OTHER WARRANTIES, EXPRESS OR IMPLIED, INCLUDING THE WARRANTIES OF MERCHANTABILITY AND FITNESS, EXCEPT FOR THE EMISSIONS CONTROL SYSTEM WARRANTY BELOW.

SETUP

To take advantage of this warranty, the product or part must be returned to us with transportation charges prepaid. Proof of purchase date and an explanation of the complaint must accompany the merchandise. If our inspection verifies the defect, we will either repair or replace the product at our election or we may elect to refund the purchase price if we cannot readily and quickly provide you with a replacement. We will return repaired products at our expense, but if we determine there is no defect, or that the defect resulted from causes not within the scope of our warranty, then you must bear the cost of returning the product.

This warranty gives you specific legal rights and you may also have other rights which vary from state to state.

OPERATION

MAINTENANCE

Emissions Control System Warranty

Harbor Freight Tools (HFT) is pleased to explain the emissions control system warranty on your Small Off-Road Engine produced after January 1, 2024 (engine), in addition to the Retail Warranty above. HFT warrants that the emissions control system on your engine is designed, built, and equipped so that it conforms to the United States Environmental Protection Agency's (EPA) emissions requirements in effect at the time of manufacture. HFT also warrants that the emissions control system on your engine will be free from defects in material and workmanship for two (2) years, provided there has been no improper maintenance, misuse, or abuse of your engine.

Your emissions control system may include parts such as the carburetor or fuel-injection system, and the ignition system. Also included may be hoses, belts, connectors and other emissions-related assemblies.

WHAT WE WILL DO

Where a warrantable condition exists, HFT will repair or replace, at our option, any emissions-related part on your engine if it becomes defective, malfunctions, or otherwise fails to conform with this warranty under normal use and service during the two (2) year term of this warranty at no cost to you, including diagnosis, parts and labor. This warranty applies to the original purchaser and any subsequent owner within the two year warranty period.

WHAT IS COVERED?

The following parts are examples of components of the emissions control system and are covered by this two (2) year warranty. For a full list of emissions control components covered by this warranty, please see 40 CFR §1068, Appendix I.

1. Fuel Metering System
 - a. Carburetor and its internal parts.
 - b. Fuel pump (if so equipped).
 - c. Cold start enrichment system.
2. Air Induction System
 - a. Intake pipe/manifold.
 - b. Air cleaner.
3. Ignition System
 - a. Spark plug.
 - b. Magneto ignition system.
4. Catalyst System (if so equipped)
 - a. Exhaust pipe stud.
 - b. Muffler.
 - c. Catalytic converter (if so equipped).
5. Miscellaneous Items Used in Above Systems
 - a. Vacuum, temperature and time sensitive valves and switches.
 - b. Hoses, belts, connectors, and assemblies.

This warranty does not cover normal maintenance services or replacement of maintenance items such as filters, oils, or spark plugs.

WHAT YOU MUST DO TO OBTAIN WARRANTY SERVICE

As the engine owner, you are responsible for the performance of the required maintenance listed in your Owner's Manual. HFT may deny you warranty coverage if your engine or a part has failed due to abuse (including failure to follow the fuel use instructions contained in this manual), neglect, improper maintenance, or unapproved modifications.

In order to obtain warranty repair or replacement, you may either (a) contact HFT product support at 1-888-866-5797 or productsupport@harborfreight.com; or (b) bring the engine/equipment to your nearest Harbor Freight Tools retail store. When going to the retail store or contacting product support, you must indicate the specific emissions control part or defect that you are claiming and the date this was originally purchased. The nearest Harbor Freight Tools retail store can be found on the internet at <http://www.harborfreight.com>

PREDATOR®

26677 Agoura Road • Calabasas, CA 91302 • 1-888-866-5797