

Owner's Manual & Safety Instructions

Save This Manual Keep this manual for the safety warnings and precautions, assembly, operating, inspection, maintenance and cleaning procedures. Write the product's serial number in the back of the manual (or month and year of purchase if product has no number). Keep this manual and the receipt in a safe and dry place for future reference.

24h

PREDATOR

6500 WATT PORTABLE GENERATOR

5500 RUNNING WATTS
6500 MAX STARTING WATTS



72920

Visit our website at: <https://www.harborfreight.com>
Email our technical support at: productsupport@harborfreight.com
Email our engine support at: predator@harborfreight.com

⚠ DANGER

Using a generator indoors CAN KILL YOU IN MINUTES.

Generator exhaust contains carbon monoxide. This is a poison you cannot see or smell.



NEVER use inside a home or garage, **EVEN IF** doors and windows are open.

Only use **OUTSIDE** and far away from windows, doors, and vents.

⚠ DANGER

Do not use in trailers, truck beds, or tents.

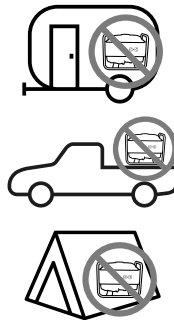

Use at least 20 feet away from people, animals, and structures with exhaust pointed away.

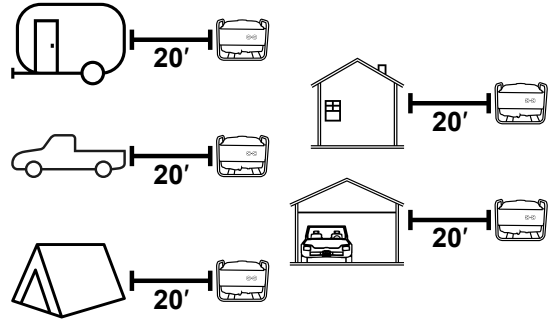

When unpacking, make sure that the product is intact and undamaged. If any parts are missing or broken, please call 1-888-866-5797 as soon as possible.

⚠ WARNING

Read this material before using this product. Failure to do so can result in serious injury. SAVE THIS MANUAL.





Copyright © 2024 by Harbor Freight Tools®. All rights reserved.
No portion of this manual or any artwork contained herein may be reproduced in any shape or form without the express written consent of Harbor Freight Tools. Diagrams within this manual may not be drawn proportionally. Due to continuing improvements, actual product may differ slightly from the product described herein.
Tools required for assembly and service may not be included.

Table of Contents

Safety	2	Maintenance	17
Setup	7	Parts List and Diagram	24
Specifications	7	Warranty	26
Operation.....	11		

PREDATOR

WARNING SYMBOLS AND DEFINITIONS

	This is the safety alert symbol. It is used to alert you to potential personal injury hazards. Obey all safety messages that follow this symbol to avoid possible injury or death.
	Indicates a hazardous situation which, if not avoided, will result in death or serious injury.
	Indicates a hazardous situation which, if not avoided, could result in death or serious injury.
	Indicates a hazardous situation which, if not avoided, could result in minor or moderate injury.
	Addresses practices not related to personal injury.

IMPORTANT SAFETY INSTRUCTIONS

SAVE THESE INSTRUCTIONS

This manual contains important instructions that should be followed during installation and maintenance of the Generator and any batteries.

Set up Precautions

1. This unit is to be installed so that access is restricted to only qualified service personnel who have been instructed of the reasons for the restrictions applied to the location and about any precautions that must be taken. Access shall be through the use of a special tool, or lock and key, or other means of security and shall be controlled by the authority responsible for the location.
2. Gasoline fuel and fumes are flammable, and potentially explosive. Use proper fuel storage and handling procedures. Do not store fuel or other flammable materials nearby.
3. Have multiple ABC class fire extinguishers nearby.
4. Operation of this equipment may create sparks that can start fires around dry vegetation. A spark arrestor may be required. The operator should contact local fire agencies for laws or regulations relating to fire prevention requirements.
5. Set up and use only on a flat, level, well-ventilated surface.
6. All connections and conduits from the Generator to the load must only be installed by trained and licensed electricians, and in compliance with all relevant local, state, and federal electrical codes and standards, and other regulations where applicable.
7. Connections for standby power to a building electrical system must be made by a qualified electrician. The connection must isolate the Generator power from utility power, and must comply with all applicable laws and electrical codes.
8. A transfer switch should be installed by a licensed electrician in compliance with all applicable laws and electrical codes.
9. Wear ANSI-approved safety goggles, heavy-duty work gloves, and dust mask/respirator during set up.
10. Use only lubricants and fuel recommended in this manual.

Set up Precautions (continued)

11. Improper connections to a building electrical system can allow electrical current from the Generator to backfeed into the utility lines. Such backfeed may electrocute utility company workers or others who contact the lines during a power outage, and the Generator may explode, burn, or cause fires when utility power is restored. Consult the utility company and a qualified electrician if intending to use the Generator for back up power.
12. Do not operate the Generator before grounding. The Generator must be earth-grounded in accordance with all relevant electrical codes and standards before operation.
13. Install carbon monoxide alarm(s) with battery backup in nearby buildings according to manufacturer's instructions.

Operating Precautions

1. **CARBON MONOXIDE HAZARD** **Using a generator indoors CAN KILL YOU IN MINUTES.**

Generator exhaust contains carbon monoxide. This is a poison you cannot see or smell.

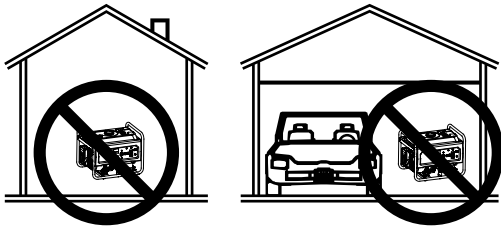

NEVER use inside a home or garage, EVEN IF doors and windows are open.

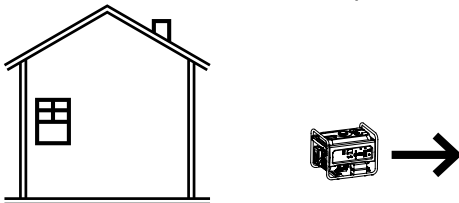

Only use OUTSIDE and far away from windows, doors, and vents.

2. **CARBON MONOXIDE SHUTOFF**

DANGER! TO PREVENT SERIOUS INJURY AND DEATH FROM CARBON MONOXIDE INHALATION:
The Carbon Monoxide sensor is an additional layer of protection only. Do not use the Generator in any area or situation that will allow carbon monoxide to accumulate.

- **FLASHING RED LIGHT:**
Dangerous levels of carbon monoxide gas have built up and generator will shutoff. Leave immediately until area has aired out. Move Generator to well-ventilated area before operation.
- **FLASHING YELLOW LIGHT:**
Carbon monoxide sensor malfunction. Sensor needs service. Do not use the Generator until the sensor is working properly. For technical questions, please call 1-888-866-5797.

NOTE: Yellow light flashes once after starting to indicate passing self-check and is functioning normally.

Carbon Monoxide sensor must only be serviced by qualified technician to restore it to original settings. Do not modify or tamper with the Carbon Monoxide sensor. Not following these instructions can result in death or serious injury due to Carbon Monoxide sensor malfunction.

3. Never use a generator indoors, including in garages, basements, crawlspaces and sheds. Opening doors and windows or using fans will NOT prevent carbon monoxide build up in the home.
4. When using generators, keep them outdoors and far away from open doors, windows, and vents to avoid toxic levels of carbon monoxide from building up indoors.
5. If you start to feel sick, dizzy, or weak while using a generator, get to fresh air right away. The carbon monoxide from generators can quickly lead to full incapacitation and death.
6. Keep children away from the equipment, especially while it is operating.
7. Keep all spectators at least six feet from the Engine during operation.
8. Do not touch engine during use. Let engine cool down after use.
9. Never store fuel or other flammable materials near the engine.
10. Fire Hazard! Do not fill gas tank while engine is running. Do not operate if gasoline has been spilled. Clean spilled gasoline before starting engine. Do not operate near pilot light or open flame.
11. If the plugged-in product operates abnormally or unusually slow, immediately stop using the Generator as a power source. Always read and adhere to the instruction manual of the product to be powered, to make sure that it can be safely and efficiently powered by a portable generator.

12. Before connecting an appliance or power cord to the Generator: Make sure that it is in good working order. Faulty appliances or power cords can create a potential for electrical shock.
13. Do not exceed the maximum power rating of the Generator. Make sure that the total electrical rating of the all of the tools or appliances plugged into the Generator at the same time does not exceed that of the Generator. Check that the startup surge will not be beyond the limit of the Generator. Power levels between rated and maximum may be used for no more than 30 minutes.
14. Avoid substantially overloading which will trip the circuit breaker. Exceeding the time limit for maximum power operation or slightly overloading the Generator may not switch the circuit breaker or circuit protector OFF, but will shorten the service life of the Generator.
15. Do not attempt to connect or disconnect load connections while standing in water, or on wet or soggy ground.
16. Do not touch electrically energized parts of the Generator and interconnecting cables or conductors with any part of the body, or with any non-insulated conductive object.
17. Connect the Generator only to a load or electrical system (120 volt or 240 volt) that is compatible with the electrical characteristics and rated capacities of the Generator.
18. **GFCI PRECAUTIONS**
Test Ground Fault Circuit Interrupter (GFCI) receptacles before each use as follows:
 - a. Disconnect all devices from the Generator.
 - b. Start the engine.
 - c. Press Test button on receptacle to trip the GFCI device.
 - d. The Reset button should extend, cutting off electricity to the receptacle.
 - e. If above test fails, do not use receptacle until it is repaired or replaced.
 - f. Press Reset button in for use.

The Generator must be grounded before use. An ungrounded Generator has an increased risk of electric shock. Refer to *Grounding* on page 9.
19. Insulate all connections and disconnected wires.
20. Guard against electric shock. Prevent body contact with grounded surfaces such as pipes, radiators, ranges, and refrigerators.
21. Only use a suitable means of transport and lifting devices with sufficient weight bearing capacity when transporting the Generator.
22. Secure the Generator on transport vehicles to prevent the tool from rolling, slipping, and tilting.
23. Industrial applications must follow OSHA requirements.
24. Do not leave the Generator unattended when it is running. Turn off the Generator (and remove safety keys, if available) before leaving the work area.
25. The Generator engine can produce high noise levels. Prolonged exposure to noise levels above 85 dBA is hazardous to hearing. Always wear ear protection when operating or working around the gas engine while it is operating.
26. Wear ANSI-approved safety glasses, hearing protection, and NIOSH-approved dust mask/respirator during use.
27. People with pacemakers should consult their physician(s) before use. Electromagnetic fields in close proximity to a heart pacemaker could cause pacemaker interference or pacemaker failure. Caution is necessary when near the engine's magneto or recoil starter.
28. Use only accessories that are recommended by Harbor Freight Tools for your model. Accessories that may be suitable for one piece of equipment may become hazardous when used on another piece of equipment.
29. Do not operate in explosive atmospheres, such as in the presence of flammable liquids, gases, or dust. Gasoline-powered engines may ignite the dust or fumes.
30. Keep grounded conductive objects, such as tools, away from exposed, live electrical parts and connections to avoid sparking or arcing. These events could ignite fumes or vapors.
31. Stay alert, watch what you are doing and use common sense when operating this piece of equipment. Do not use this piece of equipment while tired or under the influence of drugs, alcohol or medication.
32. Dress properly. Do not wear loose clothing or jewelry. Keep hair, clothing and gloves away from moving parts. Loose clothes, jewelry or long hair can be caught in moving parts.
33. Parts, especially exhaust system components, get very hot during use. Stay clear of hot parts.
34. Do not cover the Generator or its engine during operation.
35. Keep the Generator, its engine, and surrounding area clean at all times.
36. Do not smoke, or allow sparks, flames, or other sources of ignition around the equipment, especially when refuelling.
37. Use the Generator, accessories, etc., in accordance with these instructions and in the manner intended for the particular type of equipment, taking into account the working conditions and the work to be performed. Use of the equipment for operations different from those intended could result in a hazardous situation.

38. Do not operate the Generator with known leaks in the engine's fuel system.
39. When spills of fuel or oil occur, they must be cleaned up immediately. Dispose of fluids and cleaning materials as per any local, state, or federal codes and regulations. Store oil rags in a bottom-ventilated, covered, metal container.
40. Keep hands and feet away from moving parts. Do not reach over or across Generator while operating.
41. Before use, check for misalignment or binding of moving parts, breakage of parts, and any other condition that may affect the Generator's operation. **If damaged, have the Generator serviced before using.** Many accidents are caused by poorly maintained equipment.
42. Use the correct generator for the application. Do not modify the generator or its engine, and do not use the generator for a purpose for which it is not intended.
43. Extension Cord - Make sure your extension cord is in good condition. When using an extension cord, be sure to use one heavy enough to carry the current your product will draw. An undersized extension cord will cause a drop in line voltage resulting in loss of power and overheating.

The following table shows the correct cord size to use depending on cord length and nameplate ampere rating. If in doubt, use the next heavier gauge. The smaller the gauge number, the heavier the cord.

RECOMMENDED MINIMUM WIRE GAUGE FOR EXTENSION CORDS					
CURRENT (AMPS)	Load @ 120V (WATTS)	Load @ 240V (WATTS)	0 ~ 50 ft	50 ~ 75 ft	75 ~ 100 ft
2	240	480	18 AWG		
4	480	960	18 AWG		16 AWG
6	720	1440	18 AWG	16 AWG	14 AWG
8	960	1920	16 AWG		12 AWG
10	1200	2400	16 AWG	14 AWG	12 AWG
15	1800	3600	14 AWG	12 AWG	10 AWG
20	2400	4800	12 AWG	10 AWG	
25	3000	6000	12 AWG	10 AWG	8 AWG
30	3600	7200	10 AWG	8 AWG	
35	4200	8400	8 AWG	6 AWG	
40	4800	9600	6 AWG		

Button/Coin Battery Safety

⚠️ WARNING

- **INGESTION HAZARD:** This product contains a button cell or coin battery.
- **DEATH** or serious injury can occur if ingested.
- A swallowed button cell or coin battery can cause **Internal Chemical Burns** in as little as **2 hours**.
- **KEEP** new and used batteries **OUT OF REACH OF CHILDREN**
- **Seek immediate medical attention** if a battery is suspected to be swallowed or inserted inside any part of the body.



This symbol means:

INGESTION HAZARD: This product contains a button cell or coin battery.

1. Remove and immediately recycle or dispose of used batteries according to local regulations and keep away from children. Do NOT dispose of batteries in household trash or incinerate.
2. Even used batteries may cause severe injury or death.
3. Call a local poison control center for treatment information.
4. Non-rechargeable batteries are not to be recharged.
5. Do not force discharge, recharge, disassemble, heat above 85° (temperature rating) or incinerate. Doing so may result in injury due to venting, leakage or explosion resulting in chemical burns.

Service Precautions

SAFETY

1. **Before service, maintenance, or cleaning:**
 - a. **Unplug all devices from the Generator.**
 - b. **Turn the engine switch to its “OFF” position.**
 - c. **Allow the engine to completely cool.**
 - d. **Then, remove the spark plug cap from the spark plug.**
2. Keep all safety guards in place and in proper working order. Safety guards include muffler, air cleaner, mechanical guards, and heat shields, among other guards.
3. Make sure the Engine Switch is in its “OFF” position before moving the Generator and before performing any service, maintenance, or cleaning procedures on the unit.
4. Keep all electrical equipment clean and dry. Replace any wiring where the insulation is cracked, cut, abraded, or otherwise degraded. Replace terminals that are worn, discolored, or corroded. Keep terminals clean and tight.
5. **Do not alter or adjust any part of the equipment or its engine that is sealed by the manufacturer or distributor. Only a qualified service technician may adjust parts that may increase or decrease governed engine speed.**
6. Wear ANSI-approved safety goggles, heavy-duty work gloves, and dust mask/respirator during service.
7. Maintain labels and nameplates on the equipment. These carry important information. If unreadable or missing, contact Harbor Freight Tools for a replacement.
8. Have the equipment serviced by a qualified repair person using only identical replacement parts. This will ensure that the safety of the equipment is maintained. Do not attempt any service or maintenance procedures not explained in this manual or any procedures that you are uncertain about your ability to perform safely or correctly.
9. Store equipment out of the reach of children.
10. Follow scheduled engine and equipment maintenance.

SETUP

GFCI Protection:

This Generator is equipped with two 3-Prong, duplex 120V ground fault circuit interrupter (GFCI) receptacles. These outlets provide additional protection from the risk of electric shock. Should replacement of the receptacles become necessary, use only identical replacement parts that include GFCI protection.

Refueling:

1. Do not refill the fuel tank while the engine is running or hot.
2. Do not smoke, or allow sparks, flames, or other sources of ignition around the equipment, especially when refuelling.
3. **TO PREVENT FUEL LEAKAGE AND FIRE HAZARD, Do not overfill with fuel. Fill with fuel according to the Fuel Level information below the Specification chart for your model.**
4. Do not fill fuel tank to the top. Leave a little room for the fuel to expand as needed.
5. Refuel in a well-ventilated area only.
6. Wipe up any spilled fuel and allow excess to evaporate before starting engine.
To prevent FIRE, do not start the engine while the smell of fuel hangs in the air.

OPERATION

MAINTENANCE



SAVE THESE INSTRUCTIONS.

Functional Description

Specifications

Generator	Output	120/240VAC, 60Hz 46A at 120V; 23A at 240V 5,500 Running Watts (6,500 Max. Starting Watts)	
	Electrical Receptacle	Two 3-Prong, duplex NEMA #5-20 120V GFCI One 4-Prong, NEMA #L14-30 twistlock 120V/240V One DC Outlet 12VDC	
	Battery Type	CR2032 3V (1) (non-replaceable)	
Engine	Displacement	301 cc	
	Engine Type	Horizontal Single Cylinder 4 stroke OHV	
	Cooling System	Forced air cooled	
	Fuel	Type	87+ octane stabilizer treated unleaded gasoline
		Capacity	7.93 Gallon / 30.00 Liter
	Engine Oil	Type SAE	10W-30 above 32° F 5W-30 at 32° F or below
		Capacity	1 Quart
	Spark Plug	Type	NHSP® / Torch® F6TC
		Gap	0.028"–0.031"
	Valve Clearance	Intake	0.002"–0.004"
		Exhaust	0.002"–0.004"
Run Time @ 50% load	Up to 14.5 hr.		
Available accessories		Wheel kit (sold separately)	

The emission control system for this Generator's Engine is warranted for standards set by the U.S. Environmental Protection Agency and by the California Air Resources Board (also known as CARB). For warranty information, refer to the last pages of this manual.

Components and Controls

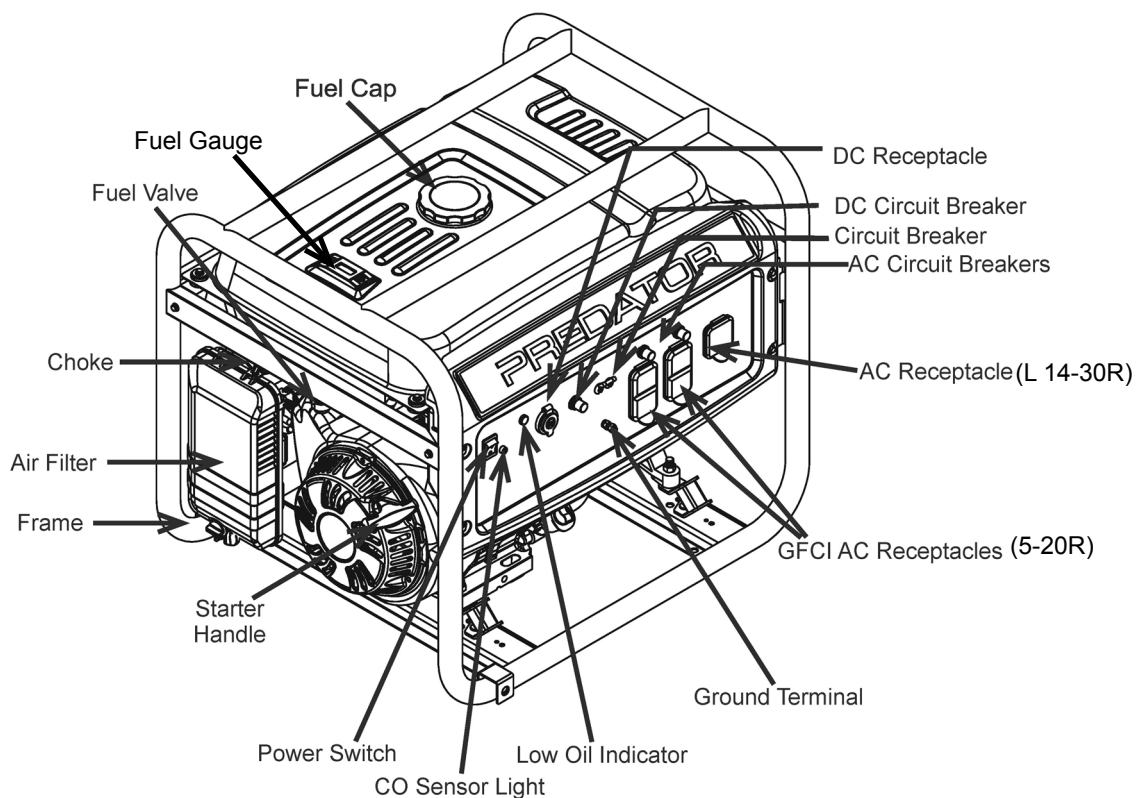

Components and Controls (continued)

SAFETY

The following are descriptions of the controls on the power panel. Your Generator has sockets to power your products with circuit breakers to protect the voltage flow.

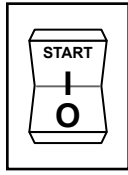

1. **Engine Switch:** Used to start and stop the Engine.

2. **AC Receptacles:** The Generator contains several AC Receptacles to power tools and equipment.

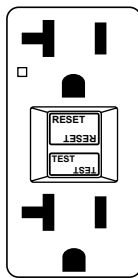

- a. **3-Prong, duplex 120 volt GFCI receptacle (NEMA #5-20)**

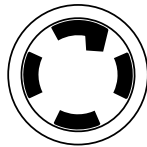

- b. **4-Prong, twistlock, 120/240 volt receptacle (NEMA #L14-30)**

⚠ WARNING! TO PREVENT SERIOUS INJURY: Connect tools and equipment only to the Receptacle (120 volt or 240 volt) that is compatible with the electrical characteristics and rated capacities of the tools and equipment being used.

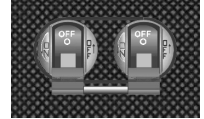

3. **Circuit Breakers:** The circuit breaker protects the Generator from overloading. The rating of the breaker and the load it protects are marked near the breaker. Should any of the Circuit Breakers trip, the Generator will stop the electricity output. If this happens, unplug all loads from the Generator. Then, turn the tripped Circuit Breaker to ON and re-attach loads gradually. **Notice:** For push type Circuit Breaker, allow a few minutes for cool-down before resetting.



4. **12 VDC Receptacle:** 12 VDC Receptacle provides a power source for 12 volt DC items.

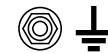

5. **Grounding Terminal:** Prior to each use, set up the ground wire (not included) connection to the Grounding Terminal to properly ground the Generator. Refer to *Grounding* on page 9 for instructions on grounding the Generator.

SETUP

OPERATION

MAINTENANCE

Initial Tool Set Up/Assembly



Read the **ENTIRE IMPORTANT SAFETY INFORMATION** section at the beginning of this manual including all text under subheadings therein before set up or use of this product.

WARNING

TO PREVENT SERIOUS INJURY:

Operate only with proper spark arrestor installed.

Operation of this equipment may create sparks that can start fires around dry vegetation. A spark arrestor may be required. The operator should contact local fire agencies for laws or regulations relating to fire prevention requirements.

At high altitudes, the engine's carburetor, governor, and any other parts that control the fuel-air ratio will need to be adjusted by a qualified mechanic to allow efficient high-altitude use and to prevent damage to the engine and any other devices used with this product.

Note: For additional information regarding the parts listed in the following pages, refer to the Assembly Diagram near the end of this manual.

NOTICE: This Generator is not intended to power sensitive electronic equipment without the addition of an appropriate line conditioner and surge protector (both not included). **Sensitive electronic equipment includes, but is not limited to, audio/video equipment, some television sets, computers, and printers.** Sensitive electronic equipment should be operated on approved inverter-type generators or pure sine wave generators.

Wheel Kit, #64788 (sold separately) can be used with this Generator.

Grounding

The Generator must be properly grounded in accordance with all relevant electrical codes and standards before operation. In many locations, local code will not require this generator to be grounded when used with cord and plug equipment plugged directly into the receptacles on the generator. However, your local regulations may require the generator to be grounded. Contact a licensed electrician or consult local authorities regarding local grounding requirements. If grounding is required, have the unit grounded by a qualified electrician if you are not qualified to do so.

General grounding instructions are as follows:

Use one of the following as the grounding electrode:

Pipe or conduit, minimum $\frac{3}{4}$ in. diameter, minimum 8 ft. long. If steel, it must have anti-corrosion coating.

Rod, stainless steel or copper- or zinc-coated steel, minimum $\frac{5}{8}$ in. diameter, minimum 8 ft. long.

1. Drive electrode at least 8 ft. vertically into the ground.
 - a. If rock layer prevents vertical entry, drive at an angle not exceeding 45 degrees from vertical.
 - b. If rock layer prevents angle entry, bury electrode in horizontal trench at least 30 in. deep.
2. The upper end of electrode must be protected if above ground level.
3. Connect a #6 AWG grounding wire (not included) from the Grounding Terminal on the Generator Control Panel to the buried electrode.

For additional information on grounding methods, please see the National Electrical Code.

NOTICE: There is a permanent conductor between the portable generator stator winding (Neutral Conductor) and the frame.

High Altitude Operation Above 3000 feet

SAFETY

⚠️WARNING! TO PREVENT SERIOUS INJURY FROM FIRE:

Follow instructions in a well-ventilated area away from ignition sources.

If the engine is hot from use, shut the engine off and wait for it to cool before proceeding. Do not smoke.

NOTICE: Warranty void if necessary adjustments are not made for high altitude use.

At high altitudes, the engine's carburetor, governor, and any other parts that control the fuel-air ratio will need to be adjusted by a qualified mechanic to allow efficient high-altitude use and to prevent damage to the engine and any other devices used with this product. The fuel system on this engine may be influenced by operation at higher altitudes. Proper operation can be ensured by installing an altitude kit at altitudes higher than 3000 ft. above sea level. At elevations above 8000 ft, the engine may experience decreased performance, even with the proper main jet. Operating this engine without the proper altitude kit installed may increase the engine's emissions and decrease fuel economy and performance. The kit should be installed by a qualified mechanic.

Note: Not all Generator models have a Solenoid. Skip those steps if a Solenoid is not present.

1. Turn off the engine.
2. Close the fuel valve.
3. Move the air cleaner housing aside to allow access to the carburetor:
 - a. Loosen the knob and remove air cleaner cover.
 - b. Remove the foam filter and deflecting plate.
 - c. Remove the nuts to allow the air cleaner housing to be moved aside.
4. Place a bowl under the fuel cup to catch any spilled fuel.
5. Unthread the screws holding the solenoid in place.

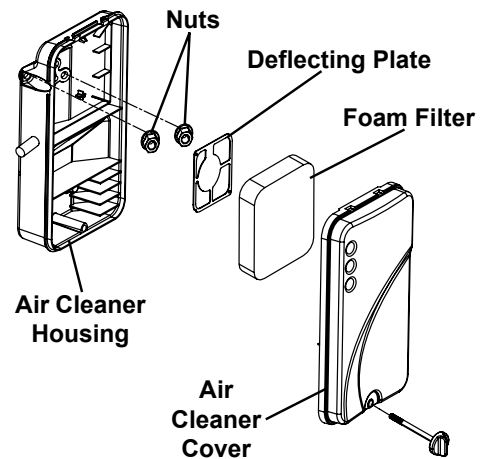

SETUP

CAUTION! Carburetor bowl may have gas in it which will leak upon removing the solenoid/bolt.

6. Disconnect the solenoid and solenoid seal from the bolt.
7. Unthread the bolt holding the fuel cup.
8. Remove the bolt, Bolt Seal, fuel cup, Fuel Cup Seal and Main Jet from the body of the carburetor assembly. A carburetor screwdriver (not included) is needed to remove and install the Main Jet.

Note: The mixing tube is held in place by the Main Jet and might fall out when it is removed. If it falls out, replace it in the same orientation before replacing the Main Jet.

9. Replace the Main Jet with the replacement Main Jet needed for your altitude range (part 1a or 2a).

Note: The Fuel Cup Seal and Bolt Seal may be damaged during removal and should be replaced with the new ones from the kit.

10. Replace the Fuel Cup Seal (4a), fuel cup, Bolt Seal (3a), and bolt. Tighten in place.

NOTICE: Do not cross thread bolt when tightening. Finger tighten first and then use a wrench to make sure the bolt is properly threaded.

11. Replace the solenoid and Solenoid Seal (5a), and tighten in place with screws.
12. Reassemble the air cleaner and reattach all hoses to it.
13. Wipe up any spilled fuel and allow excess to evaporate before starting engine. To prevent FIRE, do not start the engine while the smell of fuel hangs in the air.

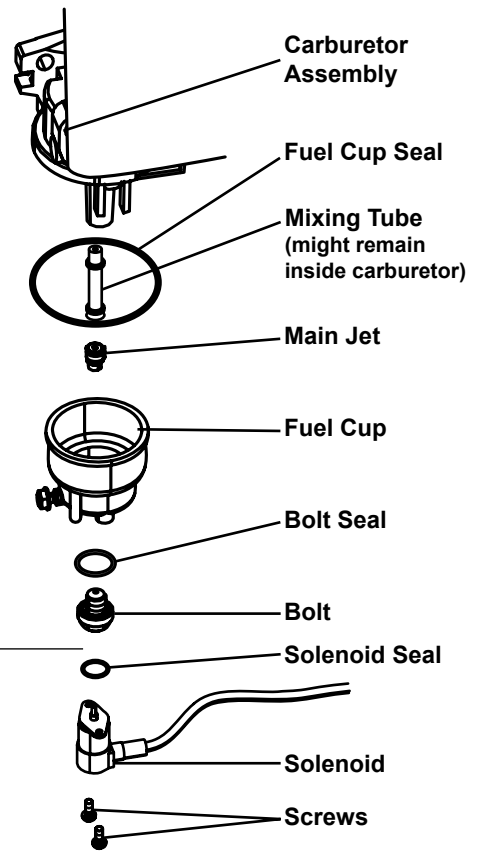

OPERATION

MAINTENANCE

High Altitude Kit Parts List - A

Part	Description	Qty
1a	Main Jet 3000-6000 ft.	1
2a	Main Jet 6000-8000 ft.	1
3a	Bolt Seal	1
4a	Fuel Cup Seal	1
5a	Solenoid Seal	1

Operating Instructions



Read the **ENTIRE IMPORTANT SAFETY INFORMATION** section at the beginning of this manual including all text under subheadings therein before set up or use of this product.

Inspect tool before use, looking for damaged, loose, and missing parts.
If any problems are found, do not use tool until repaired.

Generator Pre-Start Checks

1. Inspect engine and equipment, looking for damaged, loose, and missing parts before set up and starting. If any problems are found, do not use equipment until fixed properly.
2. Brush off outside of Engine.
3. Remove the air filter cover and the air filter elements and check for dirt. Clean as needed and replace them.
4. Install carbon monoxide alarm(s) with battery backup in all nearby buildings according to alarm manufacturer's instructions.

Checking and Filling Engine Oil

NOTICE: Your Warranty is VOID if the engine's crankcase is not properly filled with oil before each use. Before each use, check the oil level. Engine will not start with low or no engine oil.

1. Make sure the engine is stopped and is level.
2. Close the Fuel Valve.
3. Clean the top of the Dipstick and the area around it. Remove the Dipstick by threading it counterclockwise, and wipe it off with a clean lint free rag.

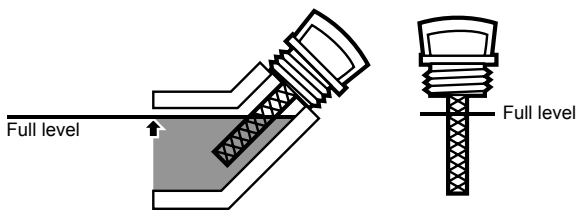

4. Reinsert the Dipstick without threading it in and remove it to check the oil level. The oil level should be up to the full level as shown above.
5. If the oil level is at or below the low mark add the appropriate type of oil until the oil level is at the proper level. SAE 10W-30 oil is recommended for general use. (The SAE Viscosity Grade chart on page 18 in the Service section shows other viscosities to use in different average temperatures.)
6. Thread the dipstick back in clockwise.

NOTICE: Do not run the engine with too little oil. Engine will shut off if engine oil level is too low.

Checking and Filling Fuel



WARNING! TO PREVENT SERIOUS INJURY FROM FIRE:

Fill the fuel tank in a well-ventilated area away from ignition sources. If the engine is hot from use, shut the engine off and wait for it to cool before adding fuel. Do not smoke.

1. Clean the Fuel Cap and the area around it.
2. Unscrew and remove the Fuel Cap.
3. If needed, fill the Fuel Tank to about 1 inch under the fill neck with 87 octane or higher unleaded gasoline that has been treated with a fuel stabilizer additive. Follow fuel stabilizer manufacturer's recommendations for use.

Note: Do not use gasoline containing more than 10% ethanol (E10). Do not use E85 ethanol.

Note: Do not use gasoline that has been stored in a metal fuel container or a dirty fuel container. It can cause particles to enter the carburetor, effecting engine performance and/or causing damage.

4. Then replace the Fuel Cap.
5. Wipe up any spilled fuel and allow excess to evaporate before starting engine. To prevent FIRE, do not start the engine while the smell of fuel hangs in the air.

Using the Generator

Before Starting the Generator Engine



Before starting the engine:

- a. Follow the Set Up Instructions to prepare the Generator.
- b. Unplug all loads from the Generator.
- c. Inspect the Generator and engine.
- d. Fill the engine with the proper amount and type of both stabilizer-treated fuel and oil.

Basic Generator Use Procedure - See following pages for specific instructions

1. Check that the Generator can handle the wattage needed to power your products.
2. Start the Engine, and allow the Engine and Generator to run and warm up for five minutes after starting with no electrical load.
3. With the engine running, test GFCI receptacles before each use as follows:
 - a. Press Test button on receptacle to trip the GFCI device.
 - b. The Reset button should extend, cutting off electricity to the receptacle.
 - c. If above test fails, do not use receptacle until it is repaired or replaced.
 - d. Press Reset button in for use.

4. Plug in products.
5. When finished using the Generator, disconnect all electrical loads.
Note: Do not allow Generator to run out of fuel with loads attached.
6. Turn off the Engine.
7. Allow the Generator and its Engine to completely cool. Then store the unit in a clean, dry, safe location out of reach of children and other unauthorized people.

IMPORTANT: After starting the engine, allow it to run at no load for five minutes with no load after each start-up so that the engine can stabilize.

8. Break-in Period:
 - a. Breaking-in the engine will help to ensure proper equipment and engine operation.
 - b. The operational break-in period will last about 3 hours of use. During this period:
 - Do not apply a heavy load to the equipment.
 - c. The maintenance break-in period will last about 20 hours of use. After this period:
 - Change the engine oil.

Under normal operating conditions subsequent maintenance follows the schedule explained in the SERVICE section.

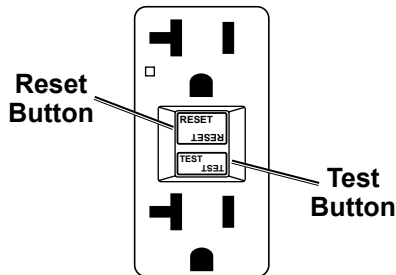

120 Volt GFCI Receptacle

Starting the Engine

1. To start a cold engine, move the Choke to the START position.
To restart a warm engine, leave the Choke in the RUN position.

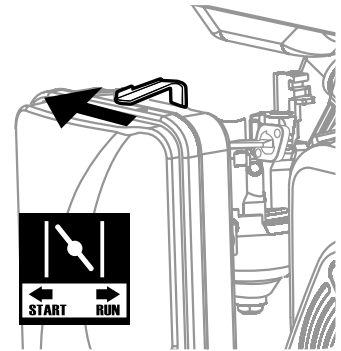

2. Open the Fuel Valve.

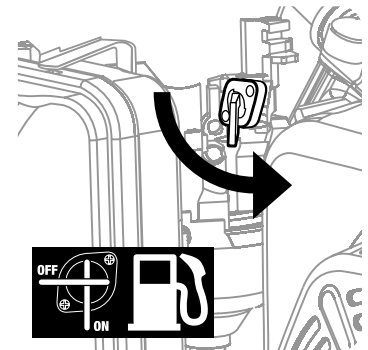

3. Turn the Engine Switch to ON.

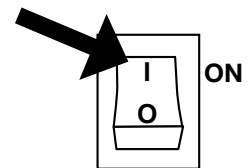

4. Grip the Starter Handle of the Engine loosely and pull it slowly several times to allow the gasoline to flow into the Engine's carburetor. Then pull the Starter Handle gently until resistance is felt. Allow Cable to retract fully and then pull it quickly. Repeat until the engine starts. Note: Do not let the Starter Handle snap back against the engine. Hold it as it recoils so it doesn't hit the engine.

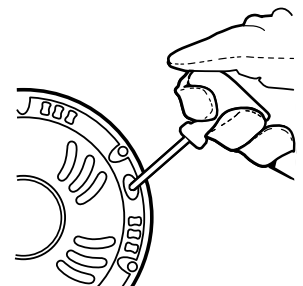

Note: If engine does not start, check engine oil level. Engine will not start with low or no engine oil.

5. Allow the Engine to run for several seconds. Then, if the Choke Lever is in the START position, move the Choke Lever very slowly to its RUN position.

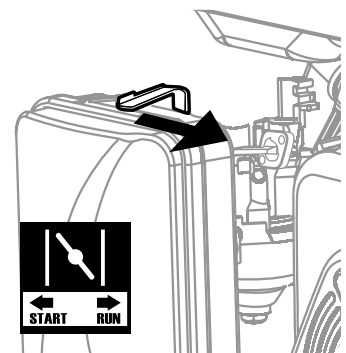

Note: Moving the Choke Lever too fast could stall the engine.

IMPORTANT: Allow the engine to run at no load for five minutes with no load after each start-up so that the engine can stabilize.

CARBON MONOXIDE SHUTOFF

DANGER! TO PREVENT SERIOUS INJURY AND DEATH FROM CARBON MONOXIDE INHALATION:
The Carbon Monoxide sensor is an additional layer of protection only. Do not use the Generator in any area or situation that will allow carbon monoxide to accumulate.

- **FLASHING RED LIGHT:**
Dangerous levels of carbon monoxide gas have built up. Leave immediately until area has aired out. Move Generator to well-ventilated area before operation.
- **FLASHING YELLOW LIGHT:**
Carbon monoxide sensor malfunction. Sensor needs service. Call 1-888-866-5797 as soon as possible. Do not use the Generator until the sensor is working properly.
NOTE: Yellow light flashes once after starting to indicate passing self-check and is functioning normally.

Carbon Monoxide sensor must only be serviced by qualified technician to restore it to original settings. Do not modify or tamper with the Carbon Monoxide sensor. Not following these instructions can result in death or serious injury due to Carbon Monoxide sensor malfunction.

Connecting Electrical Loads

Familiarize yourself with the engine controls, power panel and how to start the engine before using the Generator. Calculate the wattage of the products you will use with the Generator and verify that the Generator can handle the total load.

WARNING! Connect only properly wired plugs to the Generator. A plug that is spliced onto a different cord may be hazardous. Only a qualified electrician should wire a plug onto a cord.

NOTICE: Never exceed the rated capacity for this Generator, as serious damage to the Generator and/or appliances, tools, and equipment could result from an overload. Starting and running wattage requirements should always be calculated when matching this Generator's wattage capacity to the appliance, tool, or equipment.

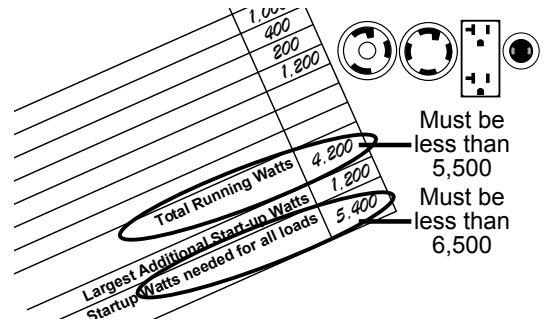

Use the DC12V Receptacle to power 12VDC equipment.

CAUTION! Do not charge batteries without a proper charge controller. Do not overcharge.

- Connect the items that require the most wattage first.
- Connect "inductive" load appliances, tools, and equipment next. Inductive loads are small hand tools and some small appliances.
- Connect any lights next.
- Voltage sensitive appliances, tools, and equipment should be the last to be connected to the Generator. Plug voltage sensitive items such as TVs, DVD players, microwaves, and cordless telephones into a UL[®] Listed voltage surge protector (not included). Then, connect the surge protector into the Generator.

IMPORTANT! Failure to connect and operate appliances, tools, and equipment in this sequence can cause damage to the Generator, appliances, tools, and equipment and will **void** the Warranty of this Generator.

Note: If Engine speed or voltage fluctuates with a load below the Generator's running watts, move the Choke Lever to the halfway position.

IF ANY CIRCUIT BREAKERS TRIP CHECK THE FOLLOWING:

- Make sure that **ALL circuit breakers** are reset before starting the Generator again.
- Adjust the plugs so the loads are shared across outlet circuits.

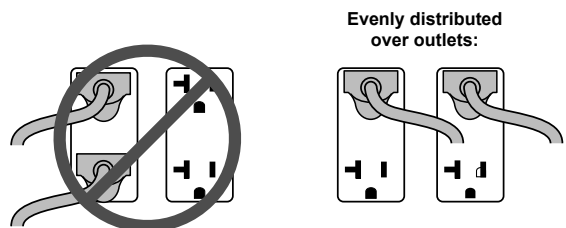

To achieve rated output from the Generator, distribute loads over outlets.

Stopping the Engine in an Emergency

SAFETY

1. To stop the engine in an emergency, turn the Engine Switch off.

NOTICE: Generator shut-off under load may damage the Generator and attached equipment.

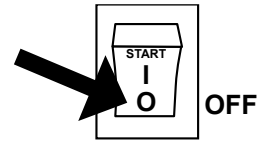

Stopping the Engine Under Normal Conditions

SETUP

1. Before turning off the Engine, turn off all electrical loads, then unplug them.

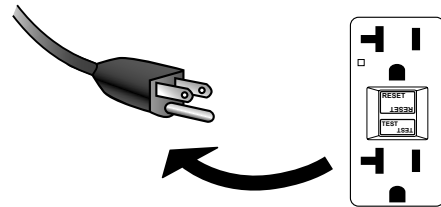

OPERATION

2. Turn the Engine Switch off.

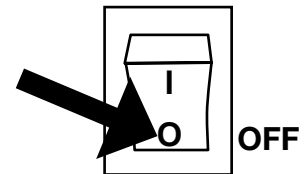

MAINTENANCE

3. Close the Fuel Valve.

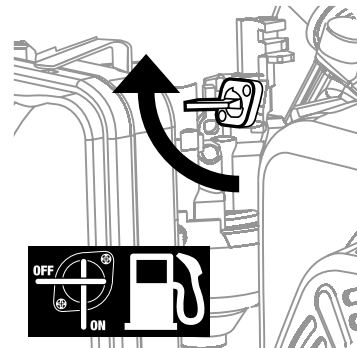

User-Maintenance Instructions



Procedures not specifically explained in this manual must be performed only by a qualified technician.

WARNING

TO PREVENT SERIOUS INJURY FROM ACCIDENTAL OPERATION:

Turn the Power Switch of the Generator to its "OFF" position, wait for the engine to cool, and disconnect the spark plug cap before performing any inspection, maintenance, or cleaning procedures.

TO PREVENT SERIOUS INJURY FROM EQUIPMENT FAILURE:

Do not use damaged equipment. If abnormal noise, vibration, or excess smoking occurs, have the problem corrected before further use.

Follow all service instructions in this manual. The engine may fail critically if not serviced properly.



Many maintenance procedures, including any not detailed in this manual, will need to be performed by a qualified technician for safety. If you have any doubts about your ability to safely service the equipment or engine, have a qualified technician service the equipment instead.

Cleaning, Maintenance, and Lubrication

Note: This maintenance schedule is intended solely as a general guide. If performance decreases or if equipment operates unusually, check systems immediately. The maintenance needs of each piece of equipment will differ depending on factors such as duty cycle, temperature, air quality, fuel quality, and other factors.

Note: The following procedures are in addition to the regular checks and maintenance explained as part of the regular operation of the engine and equipment.

Procedure	Before Each Use	Monthly or every 20 hr. of use	Every 3 mo. or 50 hr. of use	Every 6 mo. or 100 hr. of use	Yearly or every 300 hr. of use	Every 2 Years	Page
Brush off outside of engine	✓						11
Check engine oil level	✓						11
Check air cleaner	✓						11
Change engine oil		✓					18
Clean/replace air cleaner			✓*				18
Clean Spark Arrestor				✓			19
Check and clean spark plug				✓			19
1. Check/adjust idle speed 2. Check/adjust valve clearance 3. Clean fuel tank, strainer and carburetor 4. Clean carbon build-up from combustion chamber					✓**		-
Replace fuel line if necessary						✓**	-

*Service more frequently when used in dusty areas.

**These items should be serviced by a qualified technician.

Checking and Filling Fuel



⚠️ WARNING! TO PREVENT SERIOUS INJURY FROM FIRE:

Fill the fuel tank in a well-ventilated area away from ignition sources. If the engine is hot from use, shut the engine off and wait for it to cool before adding fuel. Do not smoke.

1. Clean the Fuel Cap and the area around it.
2. Unscrew and remove the Fuel Cap.

Note: Do not use gasoline containing more than 10% ethanol (E10). Do not use E85 ethanol.

Note: Do not use gasoline that has been stored in a metal fuel container or a dirty fuel container. It can cause particles to enter the carburetor, effecting engine performance and/or causing damage.

3. If needed, fill the Fuel Tank to about 1 inch under the fill neck with 87 octane or higher unleaded gasoline that has been treated with a fuel stabilizer additive. Follow fuel stabilizer manufacturer's recommendations for use.
4. Replace the Fuel Cap.
5. Wipe up any spilled fuel and allow excess to evaporate before starting engine. To prevent FIRE, do not start the engine while the smell of fuel hangs in the air.

Engine Oil Change

⚠️ CAUTION! Oil is very hot during operation and can cause burns. Wait for engine to cool before changing oil.

1. Make sure the engine is stopped and is level.
2. Close the Fuel Valve.
3. Place a drain pan (not included) underneath the crankcase's drain plug.
4. Remove the drain plug and, if possible, tilt the crankcase slightly to help drain the oil out. Recycle used oil.
5. Replace the drain plug and tighten it.
6. Clean the top of the Dipstick and the area around it. Remove the Dipstick by threading it counterclockwise, and wipe it off with a clean lint free rag.

Note: Do not thread the dipstick in when checking the oil level.

The SAE Viscosity Grade chart shows other viscosities to use in different average temperatures.

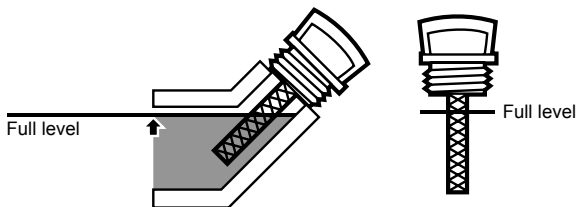
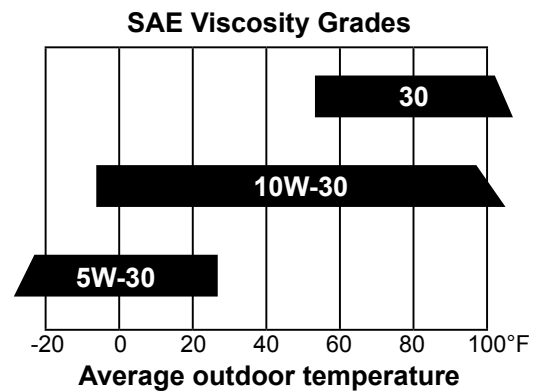

8. Thread the dipstick back in clockwise.

NOTICE: Do not run the engine with too little oil. Engine will not start with low or no engine oil.

7. Add the appropriate type of oil until the oil level is at the full level. SAE 10W-30 oil is recommended for general use.

Air Filter Element Maintenance

1. Remove the air filter cover and the air filter elements and check for dirt. Clean as described below.
2. **Cleaning:**
 - For "paper" filter elements: To prevent injury from dust and debris, wear ANSI-approved safety goggles, NIOSH-approved dust mask/respirator, and heavy-duty work gloves. In a well-ventilated area away from bystanders, use pressurized air to blow dust out of the air filter. If this does not get the filter clean, replace it.
 - For foam filter elements: Wash the element in warm water and mild detergent several times. Rinse. Squeeze out excess water and allow it to dry completely. Soak the filter in lightweight oil briefly, then squeeze out the excess oil.
3. Install the cleaned filter. Secure the Air Cleaner Cover before use.

Spark Plug Maintenance

1. Disconnect spark plug cap from end of plug. Clean out debris from around spark plug.
2. Using a spark plug wrench, remove the spark plug.
3. Inspect the spark plug:
If the electrode is oily, clean it using a clean, dry rag.
If the electrode has deposits on it, polish it using emery paper.
If the white insulator is cracked or chipped, the spark plug needs to be replaced.

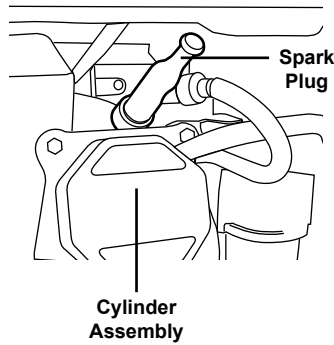

4. When installing a new spark plug, adjust the plug's gap to the specification on the Specifications chart. Do not pry against the electrode, the spark plug can be damaged.
5. Install the new spark plug or the cleaned spark plug into the engine. Gasket-style: Finger-tighten until the gasket contacts the cylinder head, then about 1/2-2/3 turn more.
Non-gasket-style: Finger-tighten until the plug contacts the head, then about 1/16 turn more.

NOTICE: Tighten the spark plug properly. If loose, the spark plug will cause the engine to overheat. If overtightened, the threads in the engine block will be damaged.

NOTICE: Using an incorrect spark plug may damage the engine. See the Specifications chart for your Generator for the type and gap required.

6. Apply dielectric spark plug boot protector (not included) to the end of the spark plug and reattach the wire securely.

Spark Arrestor Maintenance

1. Wait for Engine exhaust and Muffler to cool completely.
2. Remove Spark Arrestor from end of exhaust.
3. Brush all carbon off Spark Arrestor using a stiff brush (sold separately).

4. **WARNING! TO PREVENT SERIOUS INJURY FROM ACCIDENTAL BRUSH FIRE, secure Spark Arrestor back in place immediately after cleaning and before further operation.**

Long-Term Storage

When the equipment is to remain idle for longer than 20 days, prepare the Engine for storage as follows:

1. **CLEANING:**
Wait for Engine to cool, then clean Engine with dry cloth. **NOTICE: Do not clean using water.** The water will gradually enter the Engine and cause rust damage. Apply a thin coat of rust preventive oil to all metal parts.
2. **FUEL:**
Gasoline Treatment/Draining the Fuel Tank

To protect the fuel tank during storage, fill the tank with fresh gasoline that has been treated with a fuel stabilizer additive. Follow fuel stabilizer manufacturer's recommendations for use. Refer to Checking and Filling Fuel on page 11.

Aged gasoline that has not been treated with stabilizer ahead of time must be safely drained away and not run through the engine.



⚠ WARNING! TO PREVENT SERIOUS INJURY FROM FIRE:

Fill tank in a well-ventilated area away from ignition sources. If the engine is hot from use, shut the engine off and wait for it to cool before adding fuel. Do not smoke.

Draining the Carburetor

After closing the Fuel Valve, place an appropriate container under the Carburetor and carefully remove the Drain Bolt from the bottom of the Carburetor Bowl, allowing the fuel to drain completely. Replace the Drain Bolt after draining.

WARNING! To prevent serious injury and fire, close the Fuel Valve before draining the Carburetor.

3. **LUBRICATION:**
 - a. Change engine oil.
 - b. Clean out area around spark plug. Remove spark plug and pour one tablespoon of engine oil into cylinder through spark plug hole.
 - c. Replace spark plug, but leave spark plug cap disconnected.
 - d. Pull Starter Handle to distribute oil in cylinder. Stop after one or two revolutions when you feel the piston start the compression stroke (when you start to feel resistance).

4. STORAGE AREA:

Cover and store in a dry, level, well-ventilated area out of reach of children. Storage area should also be away from ignition sources, such as water heaters, clothes dryers, and furnaces. Avoid direct exposure to rain and sunlight.

NOTICE: During extended storage periods the Engine must be started every 3 months and allowed to run for 15–20 minutes or the Warranty is VOID.

5. AFTER STORAGE:

Before starting the Engine during or after storage, keep in mind that untreated gasoline will deteriorate quickly. Drain the fuel tank and change to fresh fuel if untreated gasoline has been sitting for a month, if treated gasoline has been sitting beyond the fuel stabilizer's recommended time period, or if the Engine does not start.

Troubleshooting

Problem	Possible Causes	Probable Solutions
Engine will not start	FUEL RELATED: <ol style="list-style-type: none"> No fuel in tank or fuel valve closed. Choke not in START position, cold engine. Gasoline with more than 10% ethanol used. (E15, E20, E85, etc.) Low quality or deteriorated, old gasoline. Carburetor not primed. Dirty fuel passageways. Carburetor needle stuck. Fuel can be smelled in the air. Too much fuel in chamber. This can be caused by the carburetor needle sticking. Clogged Fuel Filter. 	FUEL RELATED: <ol style="list-style-type: none"> Fill fuel tank with fresh 87+ octane stabilizer treated unleaded gasoline and open fuel valve. Do not use gasoline with more than 10% ethanol (E15, E20, E85, etc.). Move Choke to START position. Clean out ethanol rich gasoline from fuel system. Replace components damaged by ethanol. Use fresh 87+ octane stabilizer treated unleaded gasoline only. Do not use gasoline with more than 10% ethanol (E15, E20, E85, etc.). Use fresh 87+ octane stabilizer treated unleaded gasoline. Do not use gasoline with more than 10% ethanol (E15, E20, E85, etc.). Pull on Starter Handle to prime. Clean out passageways using fuel additive. Heavy deposits may require further cleaning. Gently tap side of carburetor float chamber with screwdriver handle. Turn Choke to RUN position. Remove spark plug and pull the start handle several times to air out the chamber. Reinstall spark plug and set Choke to START position. Replace Fuel Filter.
	IGNITION (SPARK) RELATED: <ol style="list-style-type: none"> Power Switch at OFF position. Spark plug cap not connected securely. Spark plug electrode wet or dirty. Incorrect spark plug gap. Spark plug cap broken. Circuit breaker tripped (electric start models only). Incorrect spark timing or faulty ignition system. 	IGNITION (SPARK) RELATED: <ol style="list-style-type: none"> Turn Power Switch to ON. Connect spark plug cap properly. Clean spark plug. Correct spark plug gap. Replace spark plug cap. Reset circuit breaker. Check wiring and starter motor if breaker continues to trip. Have qualified technician diagnose/repair ignition system.
	COMPRESSION RELATED: <ol style="list-style-type: none"> Cylinder not lubricated. Problem after long storage periods. Loose or broken spark plug. (Hissing noise will occur when trying to start.) Loose cylinder head or damaged head gasket. (Hissing noise will occur when trying to start.) Engine valves or tappets mis-adjusted or stuck. 	COMPRESSION RELATED: <ol style="list-style-type: none"> Pour tablespoon of oil into spark plug hole. Crank engine a few times and try to start again. Tighten spark plug. If that does not work, replace spark plug. If problem persists, may have head gasket problem, see #3. Tighten head. If that does not remedy problem, replace head gasket. Have qualified technician diagnose/repair ignition system.
	OIL RELATED: <ol style="list-style-type: none"> Low engine oil. Engine mounted on slope, triggering low oil shutdown. 	OIL RELATED: <ol style="list-style-type: none"> Fill engine oil to proper level. Check engine oil before EVERY use. Operate engine on level surface. Check engine oil level.



Follow all safety precautions whenever diagnosing or servicing the equipment or engine.

SAFETY

SETUP

OPERATION

MAINTENANCE

Troubleshooting (continued)

SAFETY

SETUP

OPERATION

MAINTENANCE

Problem	Possible Causes	Probable Solutions
Engine stops when under heavy load	<ol style="list-style-type: none"> 1. Dirty air filter. 2. Engine running cold. 	<ol style="list-style-type: none"> 1. Clean or replace element. 2. Allow engine to warm up prior to operating equipment.
Engine misfires	<ol style="list-style-type: none"> 1. Spark plug cap loose. 2. Incorrect spark plug gap or damaged spark plug. 3. Defective spark plug cap. 4. Old or low quality gasoline. 5. Incorrect compression. 	<ol style="list-style-type: none"> 1. Check wire connections. 2. Re-gap or replace spark plug. 3. Replace spark plug cap. 4. Use only fresh 87+ octane stabilizer treated unleaded gasoline. Do not use gasoline with more than 10% ethanol (E15, E20, E85, etc.). 5. Diagnose and repair compression. (Use Engine will not start: COMPRESSION RELATED section.)
Engine stops suddenly	<ol style="list-style-type: none"> 1. Carbon Monoxide level high. Red light on Carbon Monoxide Sensor illuminates. 2. CO Sensor Alarm flashes yellow continually shortly after starting. 3. CO Sensor Alarm flashes yellow continually after longer period of operation. 4. Low oil shutdown. 5. Fuel tank empty or full of impure or low quality gasoline. 6. Defective fuel tank cap creating vacuum, preventing proper fuel flow. 7. Faulty magneto. 8. Disconnected or improperly connected spark plug cap. 	<ol style="list-style-type: none"> 1. Leave area immediately and allow area to ventilate thoroughly. Only operate generator outside. 2. Carbon monoxide sensor malfunction. Sensor needs service. Call 1-888-866-5797 as soon as possible. Do not use the Generator until the sensor is working properly. 3. Make sure to operate generator within rated ambient temperature; maintain minimum 5 ft. clearance from all sides. 4. Fill engine oil to proper level. Check engine oil before EVERY use. 5. Fill fuel tank with fresh 87+ octane stabilizer treated unleaded gasoline. Do not use gasoline with more than 10% ethanol (E15, E20, E85, etc.). 6. Test/replace fuel tank cap. 7. Have qualified technician service magneto. 8. Secure spark plug cap.
Engine knocks	<ol style="list-style-type: none"> 1. Old or low quality gasoline. 2. Engine overloaded. 3. Incorrect spark timing, deposit buildup, worn engine, or other mechanical problems. 	<ol style="list-style-type: none"> 1. Fill fuel tank with fresh 87+ octane stabilizer treated unleaded gasoline. Do not use gasoline with more than 10% ethanol (E15, E20, E85, etc.). 2. Do not exceed equipment's load rating. 3. Have qualified technician diagnose and service engine.
Engine backfires	<ol style="list-style-type: none"> 1. Impure or low quality gasoline. 2. Engine too cold. 3. Intake valve stuck or overheated engine. 4. Incorrect timing. 	<ol style="list-style-type: none"> 1. Fill fuel tank with fresh 87+ octane stabilizer treated unleaded gasoline. Do not use gasoline with more than 10% ethanol (E15, E20, E85, etc.). 2. Use cold weather fuel and oil additives to prevent backfiring. 3. Have qualified technician diagnose and service engine. 4. Check engine timing.



Follow all safety precautions whenever diagnosing or servicing the equipment or engine.

Troubleshooting (continued)

Problem	Possible Causes	Probable Solutions
Product doesn't have power.	<ol style="list-style-type: none"> 1. Product not plugged in properly. 2. Circuit Breaker tripped. 3. GFCI activated. 4. Product needs service. 	<ol style="list-style-type: none"> 1. Turn off and unplug the product, then plug it back in again and turn on. 2. Turn off and unplug product. Reset Circuit Breaker. Plug in product and turn on. 3. Turn off and unplug product. Test GFCI receptacle. If functioning properly reset GFCI, plug in product and turn on. 4. Have product repaired.
Product begins to operate abnormally.	<ol style="list-style-type: none"> 1. Problem with appliance. 2. Rated load capacity exceeded. 	<ol style="list-style-type: none"> 1. Immediately unplug appliance. Have appliance repaired by a qualified technician, or replace appliance. 2. Lower the number of items plugged into the Generator to stay within the rated capacity, or use a more powerful generator.



Follow all safety precautions whenever diagnosing or servicing the equipment or engine.

PLEASE READ THE FOLLOWING CAREFULLY

THE MANUFACTURER AND/OR DISTRIBUTOR HAS PROVIDED THE PARTS LIST AND ASSEMBLY DIAGRAM IN THIS MANUAL AS A REFERENCE TOOL ONLY. NEITHER THE MANUFACTURER OR DISTRIBUTOR MAKES ANY REPRESENTATION OR WARRANTY OF ANY KIND TO THE BUYER THAT HE OR SHE IS QUALIFIED TO MAKE ANY REPAIRS TO THE PRODUCT, OR THAT HE OR SHE IS QUALIFIED TO REPLACE ANY PARTS OF THE PRODUCT. IN FACT, THE MANUFACTURER AND/OR DISTRIBUTOR EXPRESSLY STATES THAT ALL REPAIRS AND PARTS REPLACEMENTS SHOULD BE UNDERTAKEN BY CERTIFIED AND LICENSED TECHNICIANS, AND NOT BY THE BUYER. THE BUYER ASSUMES ALL RISK AND LIABILITY ARISING OUT OF HIS OR HER REPAIRS TO THE ORIGINAL PRODUCT OR REPLACEMENT PARTS THERETO, OR ARISING OUT OF HIS OR HER INSTALLATION OF REPLACEMENT PARTS THERETO.

Record Product's Serial Number Here: _____

Note: If product has no serial number, record month and year of purchase instead.

Note: Some parts are listed and shown for illustration purposes only, and are not available individually as replacement parts. Specify UPC 193175558084 when ordering parts.

Parts List and Diagram

Parts List

SAFETY

SETUP

OPERATION

MAINTENANCE

Part	Description	Qty
1	Cover Subassembly, Cylinder Head	1
2	Bolt	4
3	Tube, Breather	1
4	Gasket, Cylinder Head Cover	1
5	Bolt	1
6	Cylinder Head Cover Pin Limit Plate	2
7	Rocker, Valve	2
8	Valve Rocker Shaft Assembly	2
9	Seat, Valve Spring	2
10	Spring, Valve	2
11	Guide, Seal	1
12	Shroud, Cylinder Body	1
13	Bolt	1
14	Bolt, Cylinder Head	4
15	Bolt	2
16	Head Subassembly, Cylinder	1
17	Bolt	2
18	Gasket, Inlet	1
19	Plate, Carburetor Insulator	1
20	Gasket, Carburetor	1
21	Carburetor Assy.	1
22	Gasket, Air Cleaner	1
23	Clip	1
24	Cleaner, Air	1
25	Nut	2
26	Plug, Spark	1
27	Gasket, Cylinder Head	1
28	Pin	2
29	Valves Set	1
30	Ring Assy, Piston	1
31	Clip, Piston Pin	2
32	Piston	1
33	Pin, Piston	1
34	Rod, Connecting	1
35	Lifter Subassembly, Valve	2
36	Tappet, Valve	2
37	Bolt, Drain Plug	2
38	Washer, Flat	2
39	Coil, Ignition	1
40	Bolt	2
41	Flywheel Subassembly	1
42	Impeller	1
43	Pulley, Starter	1
44	Nut, Flywheel	1
45	Shroud	1
46	Bolt	5
47	Starter Assy, Recoil	1
48	Bolt	3
49	Seal, Oil	1
50	Plug, Rubber	1
51	Protector, Oil	1
52	Bolt	1
53	Arm, Governor	1
54	Washer, Flat	1
55	Pin	1

Part	Description	Qty
56	Spring, Throttle Valve Returning	1
57	Rod, Governor	1
58	Support Subassembly, Governor	1
59	Bolt, Governor Support	1
60	Nut	1
61	Spring, Governor	1
62	Control Assy, Throttle	1
63	Bolt	1
64	Nut	1
65	Sensor, Engine Oil	1
66	Bolt	2
67	Crankcase Subassembly.	1
68	Gasket, Exhaust Outlet	1
69	Bolt	2
70	Pipe, Exhaust	1
71	Nut	2
72	Gasket, Exhaust Outlet	1
73	Cover, Muffler Outer	1
74	Bolt	7
75	Muffler Assy.	1
76	Cover, Muffler Side	1
77	Cover, Muffler Inner	1
78	Cushion, Muffler Insulator Rubber	1
79	Bracket, Muffler	1
80	Bolt	2
81	Bolt	2
82	Camshaft Assy.	1
83	Crankshaft Assy.	1
84	Pin	2
85	Gasket, Crankcase	1
86	Bearing, Deep Groove Ball	1
87	Gear Assy, Governor	1
88	Dipstick Subassembly, Oil	1
89	Cover, Crankcase	1
90	Seal, Oil	1
91	Bolt	7
92	Nut, Stator	2
93	Washer, Flat	2
94	Motor Assembly	1
95	Shroud, Motor	1
96	Bolt	1
97	Brush Subassembly, Carbon	1
98	Bolt	5
99	Block, Terminal	1
100	Stopper, Motor Right Cover	1
101	Bracket, Motor	1
102	Bolt	1
103	Washer, Flat	1
104	Bolt, Stator	4
105	Bolt, Rotor	1
106	Bolt, Stator	2
107	Regulator, Voltage	1
108	Cover, Motor Tail	1
109	Bolt	2
110	Tank, Fuel	1

Part	Description	Qty
111	Sleeve, Fuel Tank Rubber	4
112	Bush	4
113	Washer, Flat	4
114	Bolt	4
115	Cover, Fuel Tank	1
116	Strainer, Fuel	1
117	Bolt	2
118	Leveler Assy, Oil	1
119	Valve, One Way	1
120	Hose, Fuel Steam Rubber	1
121	Clamp	1
122	Clip	1
123	Hose, Air Cleaner Rubber	1
124	Nut	2
125	Carbon Canister	1
126	Clamp	1
127	Clamp	1
128	Jacket, Rubber	1
129	Tube, Fuel	1
130	Cock Assy, Fuel	1
131	Bolt	2
132	Crosspiece Subassembly	1
133	Bolt	1
134	Support, Atr Cleaner	1
135	Seat, Engine Frame Shock Absorption	4
136	Bolt	4
137	Nut	4
138	Cushion, Engine Frame Right	2
139	Nut	4
140	Jacket, Rubber	2
141	Cushion, Engine Frame	2
142	Frame Assy, Engine	1
143	Grounding	1
144	Washer, Serrated Lock External Teeth	1
145	Nut	6
146	Co Sensor	1
147	Screw	2
148	Seat, Panel	1
149	Bolt	4
150	Switch Subassembly	1
151	Indicator	1
152	Oil Alarm Indicator	1
153	Socket Subassembly, D.C	1
154	CO Controller	1
155	Protector, Overcurrent	1
156	Double Pole Circuit Breaker	1
157	Terminal Subassembly, Grounding	2
158	Protector, Overcurrent	2
159	Rain Cover Receptacle	2
160	Socket Subassembly, Power Supply	2
161	Bridge, Rectification	2
162	Rain Cover Receptacle	1
163	Socket Subassembly, Power Supply	1

Assembly Diagram

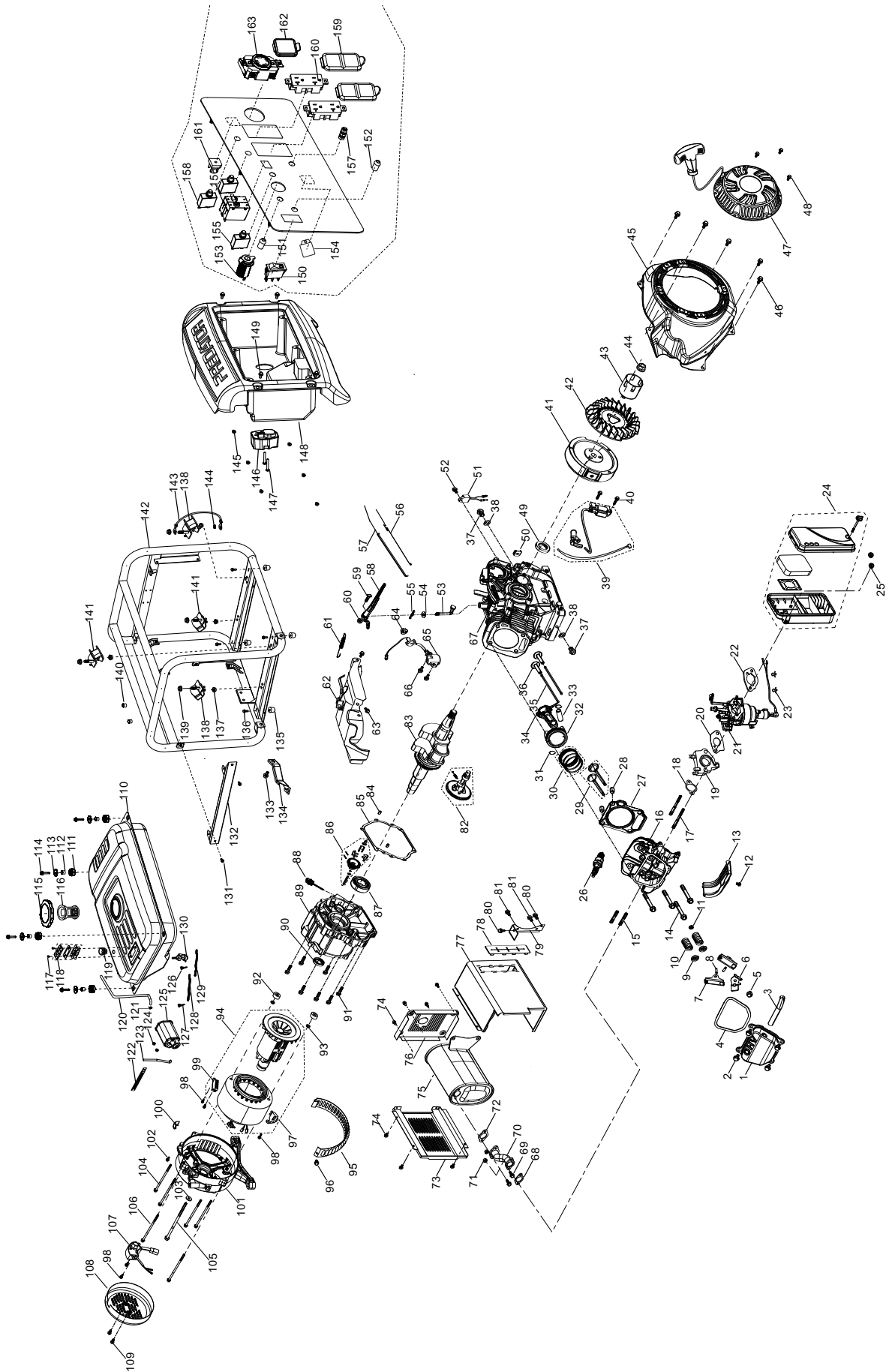

SAFETY

SETUP

OPERATION

MAINTENANCE

Limited 90 Day Warranty (Retail)

Harbor Freight Tools Co. makes every effort to assure that its products meet high quality and durability standards, and warrants to the original purchaser that this product is free from defects in materials and workmanship for the period of 90 days from the date of purchase. This warranty does not apply to damage due directly or indirectly, to misuse, abuse, negligence or accidents, repairs or alterations outside our facilities, criminal activity, improper installation, normal wear and tear, or to lack of maintenance. We shall in no event be liable for death, injuries to persons or property, or for incidental, contingent, special or consequential damages arising from the use of our product. Some states do not allow the exclusion or limitation of incidental or consequential damages, so the above limitation of exclusion may not apply to you. THIS WARRANTY IS EXPRESSLY IN LIEU OF ALL OTHER WARRANTIES, EXPRESS OR IMPLIED, INCLUDING THE WARRANTIES OF MERCHANTABILITY AND FITNESS, EXCEPT FOR THE EMISSIONS CONTROL SYSTEM WARRANTY BELOW.

To take advantage of this warranty, the product or part must be returned to us with transportation charges prepaid. Proof of purchase date and an explanation of the complaint must accompany the merchandise. If our inspection verifies the defect, we will either repair or replace the product at our election or we may elect to refund the purchase price if we cannot readily and quickly provide you with a replacement. We will return repaired products at our expense, but if we determine there is no defect, or that the defect resulted from causes not within the scope of our warranty, then you must bear the cost of returning the product.

This warranty gives you specific legal rights and you may also have other rights which vary from state to state.

Emissions Control System Warranty

The California Air Resources Board and Harbor Freight Tools (HFT) are pleased to explain the emissions control system warranty on your [Model Year] Small Off-Road Engine, in addition to the Retail Warranty above. In California, new equipment that uses small off-road engines must be designed, built, and equipped to meet the State's stringent anti-smog standards. HFT must warrant that the emissions control system on your engine will be free from defects in material and workmanship for two (2) years, provided there has been no abuse, neglect, or improper maintenance of your engine.

Your emissions control system may include parts such as the carburetor or fuel-injection system, the ignition system, catalytic converter, fuel tanks, fuel lines, fuel caps, valves, canisters, vapor hoses, clamps, connectors, and other emissions-related assemblies.

Where a warrantable condition exists, HFT will repair or replace, at our option, your engine if at no cost to you, including diagnosis, parts and labor.

MANUFACTURER'S WARRANTY COVERAGE

This emissions control system is warranted for two years. If any emission-related part on your engine is defective, the part will be repaired or replaced by HFT.

OWNER'S WARRANTY RESPONSIBILITIES

As the engine owner, you are responsible for the performance of the required maintenance listed in your Owner's Manual.

As the engine owner, you should however be aware that HFT may deny you warranty coverage if your engine or a part has failed due to abuse (including failure to follow the fuel use instructions contained in this manual), neglect, improper maintenance, or unapproved modifications.

You are responsible for contacting HFT as soon as the problem exists in order to obtain warranty repair or replacement, by doing either of the following: (a) contact HFT product support at 1-888-866-5797 or productsupport@harborfreight.com; or (b) bring the to your nearest Harbor Freight Tools retail store. The nearest Harbor Freight Tools retail store can be found on the internet at <https://www.harborfreight.com>. The warranty repairs or replacement should be completed in a reasonable amount of time, not to exceed 30 days. If you have a question regarding your warranty coverage, you should contact HFT product support at 1-888-866-5797 or productsupport@harborfreight.com.

GENERAL EMISSIONS WARRANTY COVERAGE

- a) The warranty period begins on the date the engine or equipment is delivered to an ultimate purchaser. The warranty period is two years.
- b) HFT warrants to the initial owner and each subsequent owner that the engine is:
 1. Designed, built, and equipped so as to conform with all applicable regulations adopted by the Air Resources Board; and
 2. Free from defects in materials and workmanship that causes the failure of a warranted part for a period of two years.
- c) The warranty on emissions-related parts is as follows:
 1. Any warranted part that is not scheduled for replacement as required maintenance in the written instructions provided, is warranted for the warranty period stated above. If any such part fails during the period of warranty coverage, it will be repaired or replaced HFT. Any such part repaired or replaced under the warranty will be warranted for the remaining warranty period.
 2. Any warranted part that is scheduled only for regular inspection in the written instructions is warranted for the warranty period stated above. A statement in the written instructions to the effect of "repair or replace as necessary" does not reduce the period of warranty coverage. Any such part repaired or replaced under warranty will be warranted for the remaining warranty period.
 3. Any warranted part that is scheduled for replacement as required maintenance in the written instructions will be warranted for the period of time prior to the first scheduled replacement point for that part. If the part fails prior to the first scheduled replacement, the part will be repaired or replaced by HFT. Any such part repaired or replaced under warranty will be warranted for the remainder of the period prior to the first scheduled replacement point for the part.
 4. Repair or replacement of any warranted part under the warranty will be performed at no charge to the owner at a retail store or by HFT paying for shipping the product for repair.
 5. Notwithstanding the provisions herein, warranty services or repairs will be provided at all retail stores or by contacting HFT product support at 1-888-866-5797 or productsupport@harborfreight.com.
 6. The owner will not be charged for diagnostic labor that leads to the determination that a warranted part is in fact defective, provided that such diagnostic work is performed at a retail store.
 7. HFT is liable for damages to other engine components proximately caused by a failure under warranty of any warranted part.
 8. Throughout the emissions warranty period stated above, HFT will maintain a supply of warranted parts sufficient to meet the expected demand for such parts.
 9. Any replacement part may be used in the performance of any warranty maintenance or repairs and will be provided without charge to the owner. Such use will not reduce the warranty obligations of HFT.
 10. Add-on or modified parts that are not approved by HFT may not be used. The use of any non-exempted add-on or modified parts will be grounds for disallowing a warranty claim. HFT is not liable to warrant failures of warranted parts caused by the use of a non-exempted add-on or modified part.

d) Emission Warranty Parts List.

1. Fuel Metering System
 - a. Carburetor and its internal parts (and/or pressure regulator or fuel injection system).
 - b. Fuel tank.
 - c. Cold start enrichment system.
 - d. Air/fuel ratio feedback and control system.
2. Air Induction System
 - a. Controlled hot air intake system.
 - b. Intake manifold.
 - c. Air filter.
3. Ignition System
 - a. Spark plugs.
 - b. Magneto ignition system.
 - c. Spark advance/retard system.
4. Catalyst System (if so equipped)
 - a. Exhaust pipe stud/exhaust manifold.
 - b. Thermal reactor.
 - c. Catalytic converter (if so equipped).
5. Particulate Controls
 - a. Traps, filters, precipitators, and any other device used to capture particulate emissions.
6. Miscellaneous Items Used in Above Systems
 - a. Vacuum, temperature and time sensitive valves and switches.
 - b. Hoses, belts, connectors, and assemblies.
7. Evaporative Emission Control System
 - a. Fuel tank.
 - b. Fuel caps, valves, canisters, filters, vapor hoses, clamps, connectors, belts, and assemblies.

HFT provides with each product written instructions for the maintenance and use of the product by the owner.

PREDATOR[®]

26677 Agoura Road • Calabasas, CA 91302 • 1-888-866-5797