

# Owner's Manual & Safety Instructions

Save This Manual Keep this manual for the safety warnings and precautions, assembly, operating, inspection, maintenance and cleaning procedures. Write the product's serial number in the back of the manual near the assembly diagram (or month and year of purchase if product has no number). Keep this manual and the receipt in a safe and dry place for future reference.

20J

**PITTSBURGH<sup>®</sup> AUTOMOTIVE**

**92924**

## ***Pneumatic Brake Fluid Bleeder with Auto-Refill Kit***



Visit our website at: <http://www.harborfreight.com>  
Email our technical support at: [productsupport@harborfreight.com](mailto:productsupport@harborfreight.com)

When unpacking, make sure that the product is intact and undamaged. If any parts are missing or broken, please call 1-888-866-5797 as soon as possible.

Copyright© 2020 by Harbor Freight Tools®. All rights reserved.  
No portion of this manual or any artwork contained herein may be reproduced in any shape or form without the express written consent of Harbor Freight Tools. Diagrams within this manual may not be drawn proportionally. Due to continuing improvements, actual product may differ slightly from the product described herein. Tools required for assembly and service may not be included.

### **⚠WARNING**

Read this material before using this product.  
Failure to do so can result in serious injury.  
**SAVE THIS MANUAL.**

## Specifications

Operating PSI	90 – 120 PSI	Adapter Sizes	1-1/4" – 1-19/32" (32 – 41mm)
Air Inlet Size	1/4"-18 NPT		1-3/32" – 1-15/32" (28 – 37mm)
Fill Bottle Capacity	24 oz.		31/32" – 1-1/4" (24 – 32mm)
Used Fluid Reservoir Cap.	34 oz.		25/32" – 1-7/32" (21 – 30mm)

## Important Safety Information

### WARNING!

#### READ AND UNDERSTAND ALL INSTRUCTIONS

Failure to follow instructions listed below may result in serious injury.

#### SAVE THESE INSTRUCTIONS

- 1. Keep bystanders, children, and visitors away while operating the Vacuum Pump.** Distractions can cause you to lose control. Protect others in the work area from injury.
- 2. Stay alert. Watch what you are doing, and use common sense when operating the Vacuum Pump. Do not use the tool while tired or under the influence of drugs, alcohol, or medication.** A moment of inattention while operating the tool may result in serious personal injury.
- 3. Dress properly. Do not wear loose clothing or jewelry. Contain long hair. Keep your hair, clothing, and jewelry away from moving parts.** Loose clothes, jewelry, or long hair can be caught in moving parts.
- 4. Do not overreach. Keep proper footing and balance at all times.** Proper footing and balance enables better control of the power tool in unexpected situations.
- 5. Use safety equipment.** Wear ANSI-approved safety glasses underneath a full face safety shield. Nonskid safety shoes, hard hat, or hearing protection must be used for appropriate conditions.
- 6. Do not force the tool. Use the correct tool for your application.** The correct tool will do the job better and safer at the rate for which it is designed.
- 7. Store idle tools out of reach of children and other untrained persons.** Tools are dangerous in the hands of untrained users.
- 8. Maintain tools with care. Keep tools dry and clean.** Properly maintained tools are less likely to bind and are easier to control. Do not use a damaged tool. Tag damaged tools "Do not use" until repaired.
- 9. Check for misalignment or binding of moving parts, breakage of parts, and any other condition that may affect the tool's operation. If damaged, have the tool serviced before using.** Many accidents are caused by poorly maintained tools.
- 10. Use only accessories that are recommended by the manufacturer for your model.** Accessories that may be suitable for one tool may become hazardous when used on another tool.

11. **Tool service must be performed only by qualified repair personnel.**  
Service or maintenance performed by unqualified personnel could result in a risk of injury.
12. **When servicing a tool, use only identical replacement parts. Follow instructions in the Maintenance and Servicing section of this manual.**  
Use of unauthorized parts or failure to follow maintenance instructions may create a risk of injury.
13. **Maintain a safe working environment.**  
Keep the work area well lit.  
Make sure there is adequate surrounding workspace. Keep the work area free of obstructions, grease, oil, trash, and other debris. Do not use this product in a damp or wet location.
14. **Maintain labels and nameplates on this product.** These carry important information. If unreadable or missing, contact Harbor Freight Tools for a replacement.
15. **Keep the handle dry, clean, and free from brake fluid, oil, and grease.**
16. **Before use read and understand all warnings, safety precautions, and instructions as outlined in the vehicle manufacturer's service manual.**  
Every vehicle has specific measurement values for vacuum related readings. It is beyond the scope of this manual to properly describe the correct procedure and test data for each vehicle.
17. **Carbon monoxide is produced while a vehicle's engine is operating and is deadly in a closed environment.**  
Early signs of carbon monoxide poisoning resemble the flu, with headaches, dizziness, or nausea. If you have these signs, the work area may not be vented properly. Get fresh air immediately.
18. **Prior to using the Vacuum Pump, make sure to place the vehicle's transmission in "PARK" (if automatic) or "NEUTRAL" (if manual). Then, block the tires with chocks.**
19. **Be alert for hot engine parts to avoid accidental burns.**
20. **Avoid accidental fire and/or explosion. Do not smoke near engine fuel and battery components.**
21. **Use the Brake Bleeder only with brake fluid.** Do not attempt to use the tool to siphon any other liquids. Damage to the internal chamber and seal, or future brake fluid contamination may result.
22. **Follow guidelines for proper brake fluid disposal.** Used brake fluid should be removed from the vehicle and properly recycled. Many states require recycling. Contact your local solid/liquid waste authority for information on recycling. Do not reuse old brake fluid.
23. **Brake fluid may damage paint.**  
Clean up spilled fluid quickly.
24. The warnings, precautions, and instructions discussed in this manual cannot cover all possible conditions and situations that may occur. The operator must understand that common sense and caution are factors which cannot be built into this product, but must be supplied by the operator.

# Operating Instructions



Read the **ENTIRE IMPORTANT SAFETY INFORMATION** section at the beginning of this document including all text under subheadings therein before set up or use of this product.

1. Turn the vehicle's engine off and chock the vehicle's wheels to prevent the vehicle from moving.
2. Fill the Fill Bottle (1) with clean, new, brake fluid. Use only the kind of brake fluid recommended by the vehicle manufacturer. Then, screw the Fill Nozzle (2) onto the Fill Bottle.
3. Close the Lever on the Fill Nozzle. See Figure A, below.

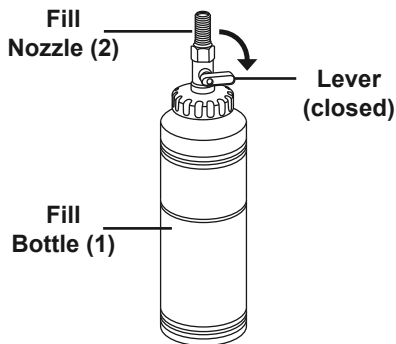

**Figure A: Fill Bottle and Fill Nozzle**

4. Remove the cap from the vehicle's master cylinder. Select the Adapter (3) which best fits the brake fluid fill hole in the master cylinder, and attach the Adapter to the Fill Nozzle (2). See Figure B.

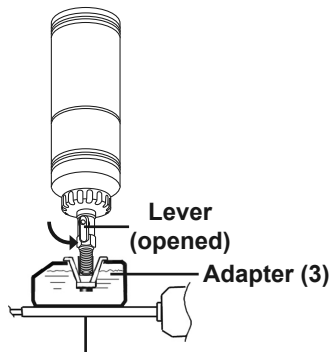

**Master Cylinder Reservoir**  
**Figure B: Master Cylinder Reservoir**

5. Turn the Fill Bottle (1) upside down and insert its tube into the brake fluid fill hole of the master cylinder, making sure the Adapter (3) fits the fluid fill hole securely.
6. Open the Lever. See Figure B.
7. Screw the Gun (6) firmly onto the Used Fluid Reservoir (4). Then, connect the Bleeding Hose (7) to the Old Fluid Bottle. See Figure C.

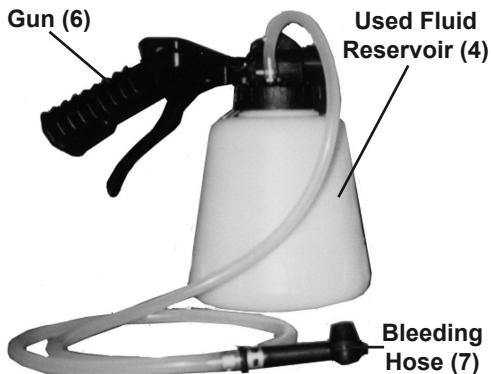

**Figure C: Used Fluid Reservoir**

8. Determine the proper brake bleeding sequence from the vehicle service manual. (i.e., right rear caliper, left rear caliper, right front caliper, left front caliper)
9. Clean the vehicle brake caliper with brake parts cleaner (not included).
10. Attach the Bleeding Hose (7) to the Bleeder Screw on the vehicle caliper. Then, connect the air compressor's air hose to the Gun (6). See Figure D.

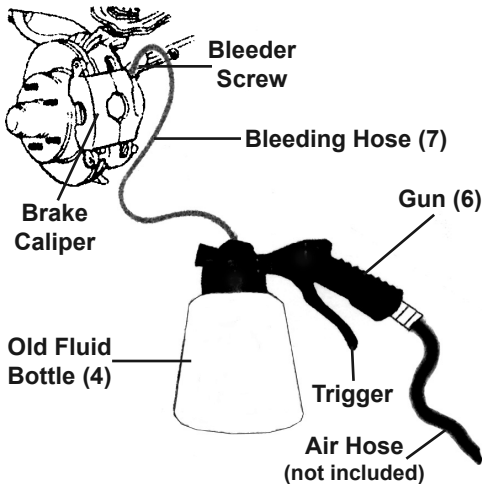

**Figure D: Caliper Connection**

11. Turn on the air compressor, and set its regulator at **90 to 120 PSI**. **Do not exceed 120 PSI.**
12. Squeeze the Trigger to create a vacuum in its Used Fluid Reservoir (4).
13. Using a bleeder screw wrench (not included), open the bleeder screw until the brake fluid starts flowing into the Oil Fluid Bottle. See Figure D.
14. Squeeze the Trigger until the old brake fluid flows freely into the Old Fluid Bottle (4).
15. If the Fill Bottle fluid level gets low:
  - a. Close the Lever and refill the Fill Bottle with clean, new brake fluid.
16. If the Used Fluid Reservoir is full, or when done bleeding the brakes:
  - a. Close then disconnect the air supply from the Gun (6).
  - b. Empty the Used Fluid Reservoir (4) of old brake fluid.
  - c. Reassemble the Gun and Used Fluid Reservoir, and resume bleeding the brakes.
17. When clean, new brake fluid with no bubbles begins to flow into the Old Fluid Bottle. Release the Trigger and retighten the caliper's bleeder screw. See Figure D.
18. Disconnect the Bleeding Hose (7) from the caliper's bleeder screw.
19. Proceed to the vehicle's next wheel, and perform the same Steps as above.
20. When finished, close the Lever and remove the Fill Bottle (1).
21. Make sure the master cylinder is full of brake fluid up to, **but not over**, its full line. (If the master cylinder is too full, correct this before proceeding.) Then, replace the cap on the master cylinder.
22. **WARNING!**  
**Before driving the vehicle:**
  - a. Depress the brake pedal repeatedly until the brake pedal feels firm.
  - b. Check the brake calipers for leaks.
  - c. Then, test the brakes thoroughly at slow speed before operating the vehicle under normal conditions.
23. Do not store fluid in the Fill Bottle or the Old Fluid Bottle. Dispose of excess fluid properly, according to all federal, state, and local guidelines. Store the Brake Fluid Bleeder in a clean, dry location out of reach of children.

## Maintenance and Servicing



Procedures not specifically explained in this manual must be performed only by a qualified technician.

### **!WARNING**

#### **TO PREVENT SERIOUS INJURY FROM ACCIDENTAL OPERATION:**

Turn off the tool, detach the air supply, and release the trigger before performing any inspection, maintenance, or cleaning procedures.

#### **TO PREVENT SERIOUS INJURY FROM TOOL FAILURE:**

Do not use damaged equipment. If abnormal noise, vibration, or leaking air occurs, have the problem corrected before further use.

1. Before each use, inspect the general condition of the Brake Fluid Bleeder. Check for misalignment or binding of moving parts, cracked or broken parts, damaged hoses, loose connections, and any other condition that may affect its safe operation.
2. CLEAN WITH A CLEAN, DRY CLOTH ONLY. Do not use any cleaners, solvents, water, or other liquids.
3. Do not store fluid in the Fill Bottle or the Old Fluid Bottle. Dispose of excess fluid properly, according to all federal, state, and local guidelines. Store the Brake Fluid Bleeder in a clean, dry location out of reach of children.

### **PLEASE READ THE FOLLOWING CAREFULLY**

THE MANUFACTURER AND/OR DISTRIBUTOR HAS PROVIDED THE PARTS LIST AND ASSEMBLY DIAGRAM IN THIS DOCUMENT AS A REFERENCE TOOL ONLY. NEITHER THE MANUFACTURER OR DISTRIBUTOR MAKES ANY REPRESENTATION OR WARRANTY OF ANY KIND TO THE BUYER THAT HE OR SHE IS QUALIFIED TO MAKE ANY REPAIRS TO THE PRODUCT, OR THAT HE OR SHE IS QUALIFIED TO REPLACE ANY PARTS OF THE PRODUCT. IN FACT, THE MANUFACTURER AND/OR DISTRIBUTOR EXPRESSLY STATES THAT ALL REPAIRS AND PARTS REPLACEMENTS SHOULD BE UNDERTAKEN BY CERTIFIED AND LICENSED TECHNICIANS, AND NOT BY THE BUYER. THE BUYER ASSUMES ALL RISK AND LIABILITY ARISING OUT OF HIS OR HER REPAIRS TO THE ORIGINAL PRODUCT OR REPLACEMENT PARTS THERETO, OR ARISING OUT OF HIS OR HER INSTALLATION OF REPLACEMENT PARTS THERETO.

# Parts List and Diagram

Part	Description	Qty
1	Fill Bottle	1
2	Fill Nozzle	1
3	Adapter Set	1 Set of 4
4	Used Fluid Reservoir	1

Part	Description	Qty
5	Muffler	1
6	Gun	1
7	Bleeding Hose	1

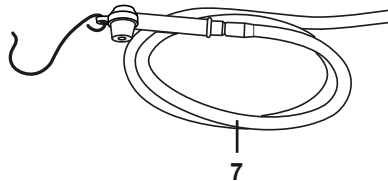
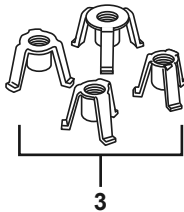
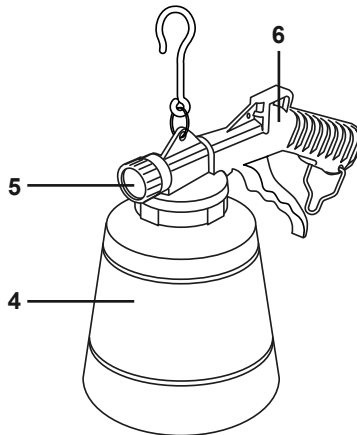
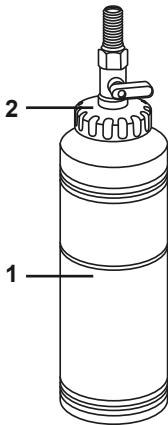

**Record Serial Number Here:** \_\_\_\_\_

**Note:** If product has no serial number, record month and year of purchase instead.

**Note:** Some parts are listed and shown for illustration purposes only, and are not available individually as replacement parts. Specify UPC 193175329448 when ordering parts.

## Limited 90 Day Warranty

Harbor Freight Tools Co. makes every effort to assure that its products meet high quality and durability standards, and warrants to the original purchaser that this product is free from defects in materials and workmanship for the period of 90 days from the date of purchase. This warranty does not apply to damage due directly or indirectly, to misuse, abuse, negligence or accidents, repairs or alterations outside our facilities, criminal activity, improper installation, normal wear and tear, or to lack of maintenance. We shall in no event be liable for death, injuries to persons or property, or for incidental, contingent, special or consequential damages arising from the use of our product. Some states do not allow the exclusion or limitation of incidental or consequential damages, so the above limitation of exclusion may not apply to you. THIS WARRANTY IS EXPRESSLY IN LIEU OF ALL OTHER WARRANTIES, EXPRESS OR IMPLIED, INCLUDING THE WARRANTIES OF MERCHANTABILITY AND FITNESS.

To take advantage of this warranty, the product or part must be returned to us with transportation charges prepaid. Proof of purchase date and an explanation of the complaint must accompany the merchandise. If our inspection verifies the defect, we will either repair or replace the product at our election or we may elect to refund the purchase price if we cannot readily and quickly provide you with a replacement. We will return repaired products at our expense, but if we determine there is no defect, or that the defect resulted from causes not within the scope of our warranty, then you must bear the cost of returning the product.

This warranty gives you specific legal rights and you may also have other rights which vary from state to state.

**PITTSBURGH<sup>®</sup> AUTOMOTIVE**

26541 Agoura Road • Calabasas, CA 91302 • 1-888-866-5797