

# Owner's Manual & Safety Instructions

**Save This Manual** Keep this manual for the safety warnings and precautions, assembly, operating, inspection, maintenance and cleaning procedures. Write the product's serial number in the back of the manual near the assembly diagram (or month and year of purchase if product has no number). Keep this manual and the receipt in a safe and dry place for future reference.

21a



## 24" High Velocity SHOP FAN



Visit our website at: <http://www.harborfreight.com>  
Email our technical support at: [productsupport@harborfreight.com](mailto:productsupport@harborfreight.com)

**93532**  
FE-60D3fOL(34)

When unpacking, make sure that the product is intact and undamaged. If any parts are missing or broken, please call 1-888-866-5797 as soon as possible.

Copyright © 2005 by Harbor Freight Tools®. All rights reserved.  
No portion of this manual or any artwork contained herein may be reproduced in any shape or form without the express written consent of Harbor Freight Tools. Diagrams within this manual may not be drawn proportionally. Due to continuing improvements, actual product may differ slightly from the product described herein. Tools required for assembly and service may not be included.

### **⚠ WARNING**





Read this material before using this product. Failure to do so can result in serious injury.  
**SAVE THIS MANUAL.**

# **READ AND SAVE THESE INSTRUCTIONS.**

## **RULES FOR SAFE OPERATION**

- 1. WARNING! To reduce the risk of fire or electric shock, do not use this Fan with any solid-state speed control device.**
- 2. This appliance has a polarized plug (one blade is wider than the other). To reduce the risk of electric shock, this plug is intended to fit into a polarized outlet only one way. If the plug does not fit fully in the outlet, reverse the plug. If it still does not fit, contact a qualified electrician. Do not change the plug in any way. Do not attempt to defeat this safety feature.**
- 3. Do not leave Fan running while unattended.**
- 4. Do not operate any fan with a damaged cord or plug. Discard fan or return to an authorized service facility for examination and/or repair.**
- 5. Do not run cord under carpeting. Do not cover cord with throw rugs, runners, or similar coverings. Arrange cord away from traffic area and where it will not be tripped over.**
- 6. Never insert fingers, pencils, or any other object through Front or Rear Blade Guards.**
- 7. Disconnect Fan when moving it from one location to another.**
- 8. Disconnect Fan before removing grills for cleaning.**
- 9. Be sure fan is on a stable surface when operating to avoid overturning.**
- 10. DO NOT use fan in window. Rain may create electrical hazard.**
- 11. Complete the assembly of the fan before switching on the fan.**
- 12. Maintain labels and nameplates on the fan. If unreadable or missing, contact Harbor Freight Tools for a replacement.**
- 13. Use only in dry areas. Do not use in bathrooms, laundry area, near sinks or other sources of water.**
- 14. This fan is not a toy. Keep it out of reach of children.**
- 15. People with pacemakers should consult their physician(s) before use. Electromagnetic fields in close proximity to heart pacemaker could cause pacemaker interference or pacemaker failure.**
- 16. The warnings, precautions, and instructions discussed in this instruction manual cannot cover all conditions and situations that may occur. It must be understood by operator that common sense and caution are factors which cannot be built into this fan, but must be supplied by operator.**

## WARNING SYMBOLS AND DEFINITIONS

	This is the safety alert symbol. It is used to alert you to potential personal injury hazards. Obey all safety messages that follow this symbol to avoid possible injury or death.
	Indicates a hazardous situation which, if not avoided, will result in death or serious injury.
	Indicates a hazardous situation which, if not avoided, could result in death or serious injury.
	Indicates a hazardous situation which, if not avoided, could result in minor or moderate injury.
	Addresses practices not related to personal injury.



## Specifications

Fan Blade	24"
Fan Guard Diameter	24-1/4"
Motor	120 VAC, Single Phase Continuous Duty
Amperage	High -1.85, Low - 1.45

---

## UNPACKING

---

When unpacking, check to make sure all the parts shown on the **Parts List on page 8** are included. If any parts are missing or broken, please call Harbor Freight Tools at the number shown on the cover of this manual as soon as possible.

---

## ASSEMBLY AND OPERATING INSTRUCTIONS

---

**NOTE:** For additional information regarding the parts listed in the following pages, refer to the **Assembly Diagram on page 9**.

**Warning!** Always make sure the Power Cord of the Fan is unplugged from its electrical outlet *prior* to making any adjustments to the fan.

**Warning!** To reduce the risk of fire or electric shock, do not use this fan with any solid-state speed control device.

### ASSEMBLY

1. Attach the two Wheels (10) to the Drum (3) using three Bolts (11) per Wheel.
2. Assemble the Base (12) to the Drum (3) using the four Bolts (11).
3. Inspect the fully assembled fan with it resting on its wheels and the base.  
**IMPORTANT: The Pads at the bottom of the Base *MUST* sit flat on the floor. If they do not, remove the Base (12), turn it 180°, and reinstall it.**

### OPERATION

1. Situate the Fan in a dry location out of children's reach and away from normal room traffic.
2. Plug in the Power Cord (8).
3. Set the Control (7) to either LOW or HIGH, depending on your preference.
4. When finished, set the Control (7) to OFF.

---

## INSPECTION, MAINTENANCE, AND CLEANING

---

1.  **WARNING! TO PREVENT SERIOUS INJURY:** Make sure the Control (7) of the Fan is in its “OFF” position and that the Fan is unplugged from its electrical outlet before performing any inspection, maintenance, or cleaning procedures.
2. **BEFORE EACH USE**, inspect the general condition of the Fan. Check for loose screws, misalignment or binding of moving parts, cracked or broken parts, damaged electrical wiring, and any other condition that may affect its safe operation. If abnormal noise or vibration occurs, have the problem corrected before further use.  
**Do not use damaged equipment.**
3. Periodically, check to see that the Blade (4) has no dirt or debris accumulating on its surface. If necessary, use compressed air to clean the unit.
4. Before each use, check that the Power Cord (8) has no tears, frays, or cracks. Do not use the Fan if you find any irregularities. Contact a qualified service technician.

---

## PARTS LIST

---

Part	Description	Qty.
1	Screw	12
2	Front Guard	1
3	Drum	1
4	Blade	1
5	Set Screw	1
6	Rear Guard	1
7	Control	1
8	Power Cord	1
9	Motor	1
10	Wheel	2
11	Bolt	10
12	Base	1

### **PLEASE READ THE FOLLOWING CAREFULLY**

THE MANUFACTURER AND/OR DISTRIBUTOR HAS PROVIDED THE PARTS LIST AND ASSEMBLY DIAGRAM IN THIS MANUAL AS A REFERENCE TOOL ONLY. NEITHER THE MANUFACTURER OR DISTRIBUTOR MAKES ANY REPRESENTATION OR WARRANTY OF ANY KIND TO THE BUYER THAT HE OR SHE IS QUALIFIED TO MAKE ANY REPAIRS TO THE PRODUCT, OR THAT HE OR SHE IS QUALIFIED TO REPLACE ANY PARTS OF THE PRODUCT. IN FACT, THE MANUFACTURER AND/OR DISTRIBUTOR EXPRESSLY STATES THAT ALL REPAIRS AND PARTS REPLACEMENTS SHOULD BE UNDERTAKEN BY CERTIFIED AND LICENSED TECHNICIANS, AND NOT BY THE BUYER. THE BUYER ASSUMES ALL RISK AND LIABILITY ARISING OUT OF HIS OR HER REPAIRS TO THE ORIGINAL PRODUCT OR REPLACEMENT PARTS THERETO, OR ARISING OUT OF HIS OR HER INSTALLATION OF REPLACEMENT PARTS THERETO.

---

## ASSEMBLY DIAGRAM

---

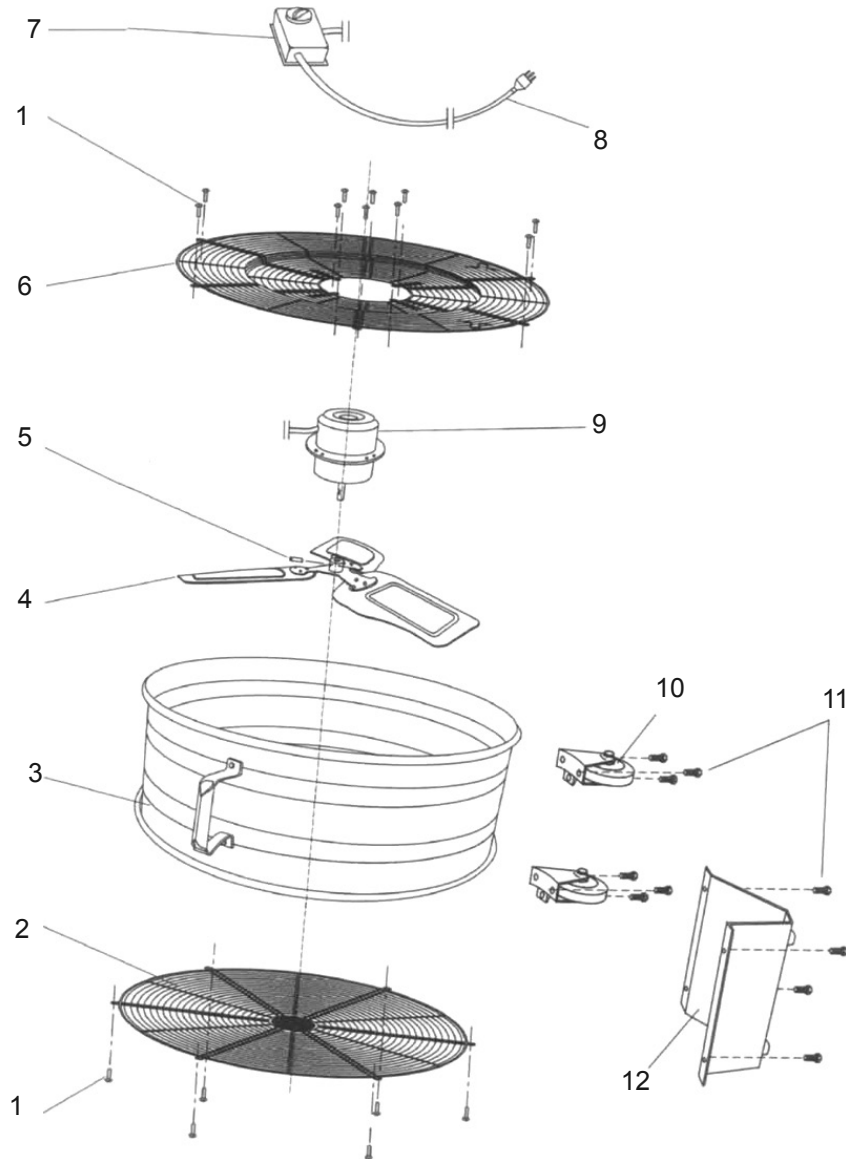

**NOTE:** Some parts are listed and shown for illustration purposes only, and are not available individually as replacement parts. Reference UPC 792363935326.

## LIMITED 90 DAY WARRANTY

Harbor Freight Tools Co. makes every effort to assure that its products meet high quality and durability standards, and warrants to the original purchaser that this product is free from defects in materials and workmanship for the period of 90 days from the date of purchase. This warranty does not apply to damage due directly or indirectly, to misuse, abuse, negligence or accidents, repairs or alterations outside our facilities, criminal activity, improper installation, normal wear and tear, or to lack of maintenance. We shall in no event be liable for death, injuries to persons or property, or for incidental, contingent, special or consequential damages arising from the use of our product. Some states do not allow the exclusion or limitation of incidental or consequential damages, so the above limitation of exclusion may not apply to you. **THIS WARRANTY IS EXPRESSLY IN LIEU OF ALL OTHER WARRANTIES, EXPRESS OR IMPLIED, INCLUDING THE WARRANTIES OF MERCHANTABILITY AND FITNESS.**

To take advantage of this warranty, the product or part must be returned to us with transportation charges prepaid. Proof of purchase date and an explanation of the complaint must accompany the merchandise. If our inspection verifies the defect, we will either repair or replace the product at our election or we may elect to refund the purchase price if we cannot readily and quickly provide you with a replacement. We will return repaired products at our expense, but if we determine there is no defect, or that the defect resulted from causes not within the scope of our warranty, then you must bear the cost of returning the product.

This warranty gives you specific legal rights and you may also have other rights which vary from state to state.



26541 Agoura Road • Calabasas, CA 91302 • 1-888-866-5797