

Owner's Manual & Safety Instructions

Save This Manual Keep this manual for the safety warnings and precautions, assembly, operating, inspection, maintenance and cleaning procedures. Write the product's serial number in the back of the manual near the assembly diagram (or month and year of purchase if product has no number). Keep this manual and the receipt in a safe and dry place for future reference.

19j



GREENWOOD™

HOME & GARDEN SPRAYER WITH 4 FOOT HOSE



95690 - 2 GALLON



63124 - 1.25 GALLON

Visit our website at: <http://www.harborfreight.com>
Email our technical support at: productsupport@harborfreight.com

ITEMS 95690 63124





When unpacking, make sure that the product is intact and undamaged. If any parts are missing or broken, please call 1-888-866-5797 as soon as possible.

Copyright© 2019 by Harbor Freight Tools®. All rights reserved.
No portion of this manual or any artwork contained herein may be reproduced in any shape or form without the express written consent of Harbor Freight Tools. Diagrams within this manual may not be drawn proportionally. Due to continuing improvements, actual product may differ slightly from the product described herein. Tools required for assembly and service may not be included.

⚠ WARNING

Read this material before using this product.
Failure to do so can result in serious injury.
SAVE THIS MANUAL.

WARNING SYMBOLS AND DEFINITIONS

	This is the safety alert symbol. It is used to alert you to potential personal injury hazards. Obey all safety messages that follow this symbol to avoid possible injury or death.
	Indicates a hazardous situation which, if not avoided, will result in death or serious injury.
	Indicates a hazardous situation which, if not avoided, could result in death or serious injury.
	Indicates a hazardous situation which, if not avoided, could result in minor or moderate injury.
	Addresses practices not related to personal injury.

IMPORTANT SAFETY INFORMATION

WARNING

Read all safety warnings and instructions.

Failure to follow the warnings and instructions may result in serious injury.

Work Area

- 1. Keep your work area clean and well lit.**
Cluttered dark areas invite accidents.
- 2. The work area should have adequate drainage to reduce the possibility of a fall due to slippery surfaces.**
- 3. Keep bystanders, children, and visitors away while operating the Sprayer.**
Distractions can cause you to lose control.

Personal Safety

- 1. Follow all guidelines regarding chemicals sprayed, including MSDS instructions and EPA regulations.**
- 2. Stay alert. Watch what you are doing and use common sense when operating the Sprayer. Do not use the Sprayer while tired or under the influence of drugs, alcohol, or medication.**
A moment of inattention while operating the Sprayer may result in serious personal injury.
- 3. Dress properly.** Do not wear loose clothing or jewelry. Contain long hair. Keep your hair and clothing away from moving parts. Loose clothes, jewelry, or long hair can be caught in moving parts.
- 4. Do not overreach. Keep proper footing and balance at all times.**
Proper footing and balance enable better control of the tool in unexpected situations.
- 5.  Always wear eye protection.**
Wear ANSI-approved safety goggles.

Use

1. **Use only for water or water-based fertilizers, herbicides, pesticides and sealers. Do not use to spray combustible or corrosive chemicals.**
2. **Release pressure in Tank by pulling up on the Pressure Release Valve before loosening or removing parts. Contents are under pressure and may spurt forcefully.**
3. Do not point the Sprayer at yourself, other people or animals.
4. Do not allow access to treated areas by people or animals.
5. Industrial applications must follow OSHA requirements.
6. Make sure the liquid used in the Sprayer is not dirty or sandy.
7. This product is not a toy. Do not allow children to play with or near this item.
8. Use as intended only.
9. Inspect before every use; do not use if parts are loose or damaged.
10. Before filling, pull up on Pressure Release Valve to ensure that it operates properly and does not stick.
11. Maintain product labels and nameplates. These carry important safety information. If unreadable or missing, contact Harbor Freight Tools for a replacement.
12. The warnings and cautions discussed in this manual cannot cover all possible conditions and situations that may occur. The operator must understand that common sense and caution are factors that cannot be built into this product, but must be supplied by the operator.

Service

1. **Have your Sprayer serviced by a qualified repair person using only identical replacement parts.**
This will ensure that the safety of the tool is maintained.
2. Store idle tools and equipment out of reach of children and other untrained people. Tools and equipment are dangerous in the hands of untrained users.
3. Maintain the Sprayer with care. Keep this product clean. A properly maintained Sprayer is easier to control.



SAVE THESE INSTRUCTIONS.

Specifications

	95690	63124
Tank Capacity	2 gallons	1.25 gallons
Hose Length	4'	
Maximum Output	45 PSI	

Components and Controls



Figure A

Assembly Instructions



Read the ENTIRE IMPORTANT SAFETY INFORMATION section at the beginning of this document including all text under subheadings therein before set up or use of this product.

1. Assemble Wand:
 - a. Loosen Wand Nut, then slide Wand into Trigger Handle Assembly.
 - b. Tighten Wand Nut securely.
2. Attach Shoulder Strap: Attach Rings to Shoulder Strap holes.

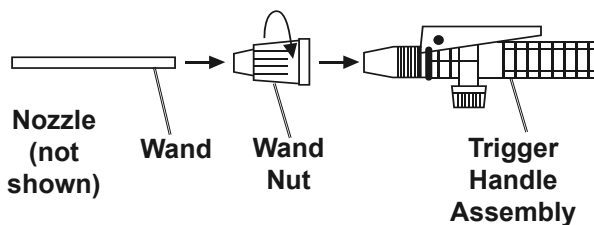

Figure B

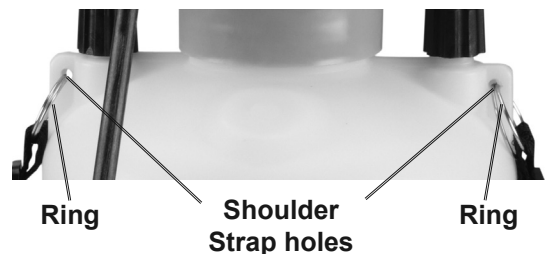

Figure C

Operating Instructions



Read the **ENTIRE IMPORTANT SAFETY INFORMATION** section at the beginning of this document including all text under subheadings therein before set up or use of this product.

WARNING

Inspect Sprayer before use, looking for damaged, loose, and missing parts.

If any problems are found, do not use Sprayer until repaired.

Follow all guidelines regarding chemicals sprayed, including MSDS instructions and EPA regulations.

Release pressure in Tank by pulling up on the Pressure Release Valve before loosening or removing parts. Contents are under pressure and may spurt forcefully.

1. Before filling, pull up on Pressure Release Valve to ensure that it operates properly and does not stick.
2. Making sure the Handle Assembly is all the way down into the Tank, turn the Handle Assembly counterclockwise to loosen it, then pull the Handle Assembly out of the Tank.
7. For continuous spray, press the Trigger down and forward until it locks, then release the Trigger. To stop continuous spray, press down and pull back on the Trigger.

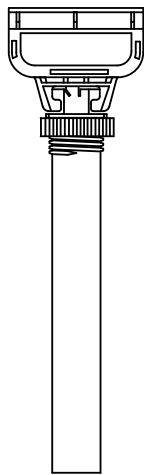

Figure D: Handle Assembly

3. Pour the liquid, through a strainer (sold separately), into the Funnel Top.
4. Insert the Handle Assembly all the way down into the Tank and turn the Handle Assembly clockwise to tighten it securely.
5. Pump the Handle to build up sufficient pressure. Once the Sprayer is pressurized (as indicated by increased tension on the Handle), discontinue pumping.
6. Point the Nozzle toward the area to be sprayed, then depress the Trigger to begin spraying.

Note: Turn Nozzle to adjust spray pattern.

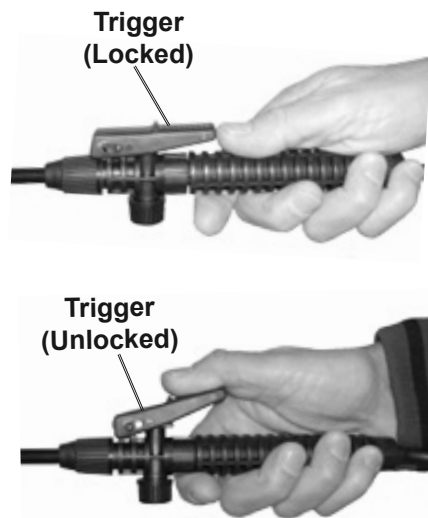

Figure E

8. As you spray, the Sprayer will depressurize. When decreased pressure is affecting spray pattern, pump the Handle until proper pressure is achieved, then resume spraying.
9. To refill the Tank, pull up on the Pressure Release Valve and remove the Handle Assembly. Then add liquid and replace the Handle Assembly. Pump the Handle until proper pressure is achieved, then resume spraying.
10. **When finished spraying:**
 - **Depressurize the Tank.**
 - **Dispose of liquid.**
 - **Clean the Sprayer according to Maintenance Instructions.**

Inspection, Maintenance, and Cleaning



Procedures not specifically explained in this manual must be performed only by a qualified technician.

⚠️WARNING

Do not use damaged equipment. If abnormal noise, vibration, or leaking air occurs, have the problem corrected before further use.

Follow all guidelines regarding chemicals sprayed, including MSDS instructions and EPA regulations.

Release pressure in Tank by pulling up on the Pressure Release Valve before loosening or removing parts. Contents are under pressure and may spurt forcefully.

1. **BEFORE EACH USE**, inspect the general condition of the Sprayer. Check for:
 - loose hardware,
 - misalignment or binding of moving parts,
 - cracked or broken parts, and
 - any other condition that may affect its safe operation.
2. **AFTER EVERY USE**, Clean the Sprayer:
 - a. Flush with water.
 - b. Clean Nozzle and Filter (35).
 - c. Rinse with water and allow to air-dry.
3. **PERIODICALLY**, lubricate all moving parts of the pump assembly with petroleum jelly.
4. Store the Sprayer in a safe, dry, clean location out of reach of children and out of sunlight.

Troubleshooting

Problem	Possible Causes	Likely Solutions
Unit does not spray	<ol style="list-style-type: none"> 1. Suction Tube (34) detached. 2. Not enough liquid in tank. 3. Handle Assembly loose. 4. Hose Nut (18) loose. 5. Safety Cap (22) loose. 6. Sprayer not pressurized. 7. Spray fluid contains particles or sand. 8. Nozzle and/or Filter clogged with mineral buildup. 	<ol style="list-style-type: none"> 1. Reattach Suction Tube. 2. Add liquid to tank. 3. Tighten Handle Assembly. 4. Tighten Hose Nut. 5. Tighten Safety Cap. 6. Pump Handle to pressurize Sprayer. 7. Disassemble, clean, then reassemble Nozzle and/or Filter. Empty, clean, then refill Tank with properly strained fluid. 8. Disassemble, clean, then reassemble Nozzle and/or Filter.
Spray pattern is undesirable	<ol style="list-style-type: none"> 1. Nozzle needs adjustment. 2. Spray fluid contains particles or sand. 3. Nozzle and/or Filter clogged with mineral buildup. 	<ol style="list-style-type: none"> 1. Adjust Nozzle. 2. Disassemble, clean, then reassemble Nozzle and/or Filter. Empty, clean, then refill Tank with properly strained fluid. 3. Disassemble, clean, then reassemble Nozzle and/or Filter.



Follow all safety precautions whenever diagnosing or servicing the Sprayer.

Record Serial Number Here:

Note: If product has no serial number, record month and year of purchase instead.

Note: Some parts are listed and shown for illustration purposes only, and are not available individually as replacement parts. Parts may not be interchangeable. Specify item number when ordering.

Parts List and Diagram

Part	Description	Qty
1	Nozzle	1
2	Separate Plate	1
3	O-Ring (14 x 2)	1
4	Bend	1
5	Wand Nut	2
6	Wand	1
7	Trigger Pin	1
8	Trigger	1
9	Switch Body	1
10	Valve Core O-Ring (6.8 x 1.6)	2
11	Valve Core O-Ring (7.6 x 1.9)	1
12	Valve Core	1
13	Switch Spring	1
14	Switch Sealing Washer	1
15	Switch Nut	1
16	Washer	1
17	Trigger Handle	1
18	Hose Nut	2
19	Hose	1
20	Pressure Release Valve	1
21	Pressure Valve Sealing Washer	1
22	Safety Cap	1

Part	Description	Qty
23	Safety Spring	1
24	Safety Seal	1
25	Flat Sealing Washer	2
26	Shoulder Strap Ring	2
27	Shoulder Strap Buckle	2
28	Shoulder Strap	1
29	Funnel Top	1
30	Tank Sealing Washer	1
31	Tank	1
32	Tank Bottom	1
33	Hose Connector	1
34	Suction Tube	1
35	Filter	1
36	Pump Nut	1
37	Direction Limiter	1
38	Piston	1
39	Piston O-Ring (35 x 4.8)	1
40	Air Tube	1
41	Air Tube Sealing Washer	1
42	Pump Sealing Washer	1
43	Handle	1

If ordering 2 Gallon parts, specify UPC 792363956901.

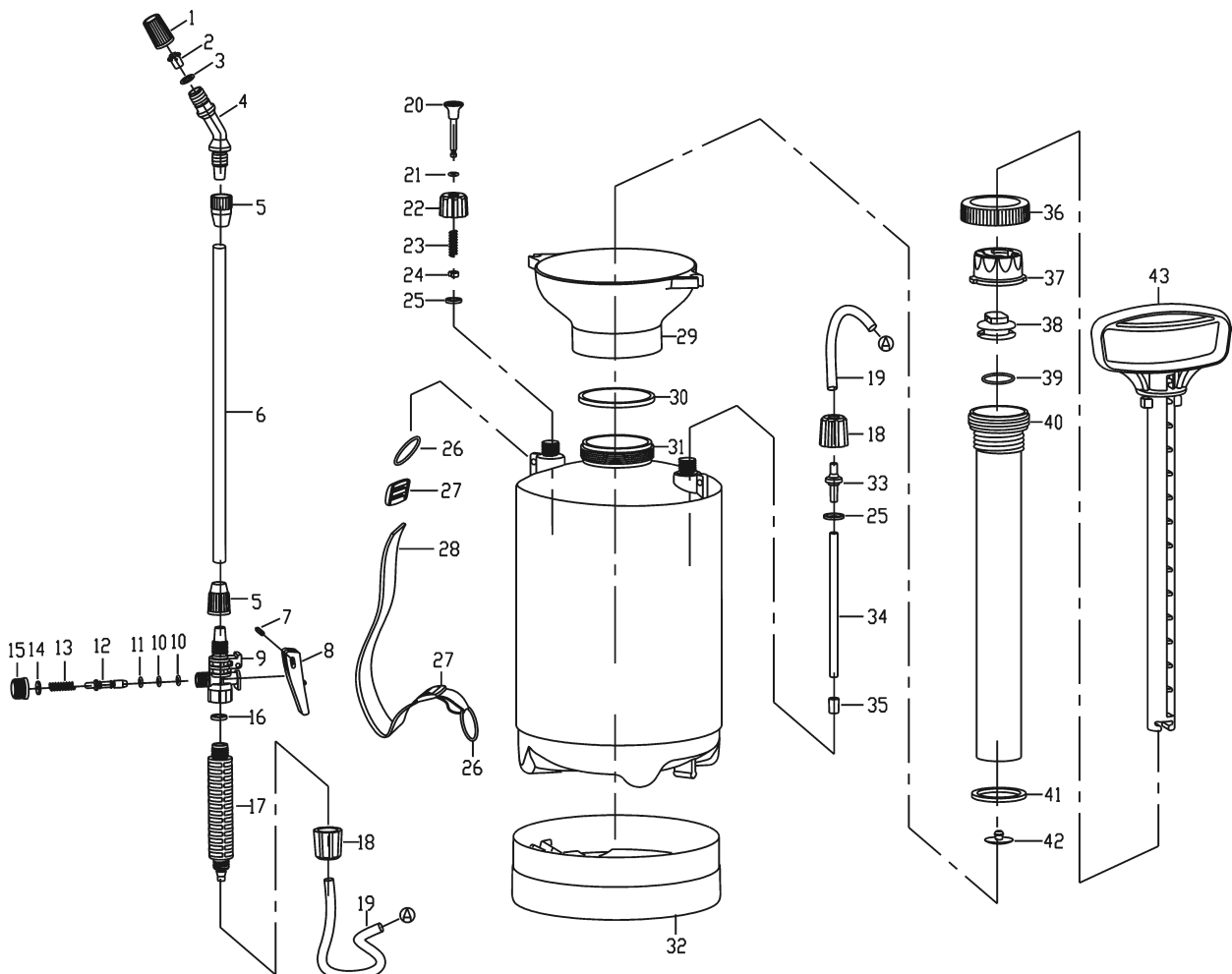

PLEASE READ THE FOLLOWING CAREFULLY

THE MANUFACTURER AND/OR DISTRIBUTOR HAS PROVIDED THE PARTS LIST AND ASSEMBLY DIAGRAM IN THIS DOCUMENT AS A REFERENCE TOOL ONLY. NEITHER THE MANUFACTURER OR DISTRIBUTOR MAKES ANY REPRESENTATION OR WARRANTY OF ANY KIND TO THE BUYER THAT HE OR SHE IS QUALIFIED TO MAKE ANY REPAIRS TO THE PRODUCT, OR THAT HE OR SHE IS QUALIFIED TO REPLACE ANY PARTS OF THE PRODUCT. IN FACT, THE MANUFACTURER AND/OR DISTRIBUTOR EXPRESSLY STATES THAT ALL REPAIRS AND PARTS REPLACEMENTS SHOULD BE UNDERTAKEN BY CERTIFIED AND LICENSED TECHNICIANS, AND NOT BY THE BUYER. THE BUYER ASSUMES ALL RISK AND LIABILITY ARISING OUT OF HIS OR HER REPAIRS TO THE ORIGINAL PRODUCT OR REPLACEMENT PARTS THERETO, OR ARISING OUT OF HIS OR HER INSTALLATION OF REPLACEMENT PARTS THERETO.

Limited 90 Day Warranty

Harbor Freight Tools Co. makes every effort to assure that its products meet high quality and durability standards, and warrants to the original purchaser that this product is free from defects in materials and workmanship for the period of 90 days from the date of purchase. This warranty does not apply to damage due directly or indirectly, to misuse, abuse, negligence or accidents, repairs or alterations outside our facilities, criminal activity, improper installation, normal wear and tear, or to lack of maintenance. We shall in no event be liable for death, injuries to persons or property, or for incidental, contingent, special or consequential damages arising from the use of our product. Some states do not allow the exclusion or limitation of incidental or consequential damages, so the above limitation of exclusion may not apply to you. THIS WARRANTY IS EXPRESSLY IN LIEU OF ALL OTHER WARRANTIES, EXPRESS OR IMPLIED, INCLUDING THE WARRANTIES OF MERCHANTABILITY AND FITNESS.

To take advantage of this warranty, the product or part must be returned to us with transportation charges prepaid. Proof of purchase date and an explanation of the complaint must accompany the merchandise. If our inspection verifies the defect, we will either repair or replace the product at our election or we may elect to refund the purchase price if we cannot readily and quickly provide you with a replacement. We will return repaired products at our expense, but if we determine there is no defect, or that the defect resulted from causes not within the scope of our warranty, then you must bear the cost of returning the product.

This warranty gives you specific legal rights and you may also have other rights which vary from state to state.



GREENWOOD™

26541 Agoura Road • Calabasas, CA 91302 • 1-888-866-5797