







# Table of Contents

Safety .....	2	Maintenance .....	12
Specifications .....	6	Parts List and Diagram .....	14
Setup .....	7	Warranty .....	16
Operation .....	10		

# CENTRALPNEUMATIC®

## WARNING SYMBOLS AND DEFINITIONS

	This is the safety alert symbol. It is used to alert you to potential personal injury hazards. Obey all safety messages that follow this symbol to avoid possible injury or death.
	Indicates a hazardous situation which, if not avoided, will result in death or serious injury.
	Indicates a hazardous situation which, if not avoided, could result in death or serious injury.
	Indicates a hazardous situation which, if not avoided, could result in minor or moderate injury.
	Addresses practices not related to personal injury.

## IMPORTANT SAFETY INSTRUCTIONS

### INSTRUCTIONS PERTAINING TO A RISK OF FIRE, ELECTRIC SHOCK, OR INJURY TO PERSONS

**WARNING** – When using tools, basic precautions should always be followed, including the following:



#### General

To reduce the risks of electric shock, fire, and injury to persons, read all the instructions before using the tool.

#### Work Area

- 1. Keep the work area clean and well lighted.**  
Cluttered benches and dark areas increase the risks of electric shock, fire, and injury to persons.
- 2. Do not operate the tool in explosive atmospheres, such as in the presence of flammable liquids, gases, or dust.**  
The tool is able to create sparks resulting in the ignition of the dust or fumes.
- 3. Keep bystanders, children, and visitors away while operating the tool.**  
Distractions are able to result in the loss of control of the tool.

# Personal Safety

- 1. Stay alert. Watch what you are doing and use common sense when operating the tool. Do not use the tool while tired or under the influence of drugs, alcohol, or medication.**  
A moment of inattention while operating the tool increases the risk of injury to persons.
- 2. Dress properly. Do not wear loose clothing or jewelry. Contain long hair. Keep hair, clothing, and gloves away from moving parts.** Loose clothes, jewelry, or long hair increases the risk of injury to persons as a result of being caught in moving parts.
- 3. Avoid unintentional starting. Be sure the switch is off before connecting to the air supply.** Do not carry the tool with your finger on the switch or connect the tool to the air supply with the switch on.
- 4. Remove adjusting keys and wrenches before turning the tool on.** A wrench or a key that is left attached to a rotating part of the tool increases the risk of personal injury.
- 5. Do not overreach. Keep proper footing and balance at all times.** Proper footing and balance enables better control of the tool in unexpected situations.
- 6.  Use safety equipment.** A dust mask, non-skid safety shoes and a hard hat must be used for the applicable conditions.
- 7.  Always wear eye protection.** Wear ANSI-approved safety goggles.
- 8.  Always wear hearing protection when using the tool.** Prolonged exposure to high intensity noise is able to cause hearing loss.

# Tool Use and Care

- 1. Use clamps or another practical way to secure and support the workpiece to a stable platform.** Holding the work by hand or against the body is unstable and is able to lead to loss of control.
- 2. Do not force the tool.** Use the correct tool for the application. The correct tool will do the job better and safer at the rate for which the tool is designed.
- 3. Do not use the tool if the switch does not turn the tool on or off.** Any tool that cannot be controlled with the switch is dangerous and must be repaired.
- 4. Disconnect the tool from the air source before making any adjustments, changing accessories, or storing the tool.** Such preventive safety measures reduce the risk of starting the tool unintentionally. Turn off and detach the air supply, safely discharge any residual air pressure, and release the throttle and/or turn the switch to its off position before leaving the work area.
- 5. Store the tool when it is idle out of reach of children and other untrained persons.** A tool is dangerous in the hands of untrained users.
- 6. Check for misalignment or binding of moving parts, breakage of parts, and any other condition that affects the tool's operation.** If damaged, have the tool serviced before using. Many accidents are caused by poorly maintained tools. There is a risk of bursting if the tool is damaged.
- 7. Use only accessories that are identified by the manufacturer for the specific tool model.** Use of an accessory not intended for use with the specific tool model, increases the risk of injury to persons.

## Service

1. **Tool service must be performed only by qualified repair personnel.**
2. **When servicing a tool, use only identical replacement parts. Use only authorized parts..**
3. **Use only lubricants supplied with the tool or specified by the manufacturer.**





## Air Source

1.  **Never connect to an air source that is capable of exceeding 200 psi.** Over pressurizing the tool may cause bursting, abnormal operation, breakage of the tool or serious injury to persons. Use only clean, dry, regulated compressed air at the rated pressure or within the rated pressure range as marked on the tool.
  2. **Never use oxygen, carbon dioxide, combustible gases or any bottled gas as an air source for the tool.** Such gases are capable of explosion and serious injury to persons.
- Always verify prior to using the tool that the air source has been adjusted to the rated air pressure or within the rated air-pressure range.



# SAVE THESE INSTRUCTIONS.

## Symbol Definitions

Symbol	Property or Statement	Symbol	Property or Statement
<b>n<sub>o</sub></b>	No-load speed	<b>NPT</b>	National pipe thread, tapered
<b>.../min</b>	Revolutions or reciprocation per minute	<b>NPS</b>	National pipe thread, straight
<b>PSI</b>	Pounds per square inch of pressure		WARNING marking concerning Risk of Eye Injury. Wear ANSI-approved eye protection.
<b>ft-lb</b>	Foot-pounds of torque		WARNING marking concerning Risk of Hearing Loss. Wear hearing protection.
<b>BPM</b>	Blows per minute		WARNING marking concerning Risk of Respiratory Injury. Wear NIOSH-approved dust mask/respirator.
<b>CFM</b>	Cubic Feet per Minute flow		WARNING marking concerning Risk of Explosion.
<b>SCFM</b>	Cubic Feet per Minute flow at standard conditions		

# Specific Safety Instructions

- 1. This air tool is intended to function as a sander. Read all safety warnings, instructions, illustrations and specifications provided with this air tool.** Failure to follow all instructions listed below may result in electric shock, fire and/or serious injury.
- 2. Operations such as grinding, wire brushing or cutting-off are not recommended to be performed with this air tool.** Operations for which the air tool was not designed may create a hazard and cause personal injury.
- 3. Do not use accessories which are not specifically designed and recommended by the tool manufacturer.** Just because the accessory can be attached to your air tool, it does not assure safe operation.
- 4. The rated speed of the accessory must be at least equal to the maximum speed marked on the air tool.** Accessories running faster than their RATED SPEED can break and fly apart.
- 5. The outside diameter and the thickness of your accessory must be within the capacity rating of your air tool.** Incorrectly sized accessories cannot be adequately guarded or controlled.
- 6. The arbor size of wheels, flanges, backing pads or any other accessory must properly fit the spindle of the air tool.** Accessories with arbor holes that do not match the mounting hardware of the air tool will run out of balance, vibrate excessively and may cause loss of control.
- 7. Do not use a damaged accessory. Before each use inspect the accessory for tears and the backing pad for cracks, tears or excess wear. If air tool or accessory is dropped, inspect for damage or install an undamaged accessory.**
- 8. Wear personal protective equipment. Depending on application, use face shield, safety goggles or safety glasses. As appropriate, wear dust mask, hearing protectors, gloves and workshop apron capable of stopping small abrasive or workpiece fragments. The eye protection must be capable of stopping flying debris generated by various operations.** The eye protection must be capable of stopping flying debris generated by various operations. The dust mask or respirator must be capable of filtering out particles generated by your operation. Prolonged exposure to high intensity noise may cause hearing loss.
- 9. Keep bystanders a safe distance away from work area. Anyone entering the work area must wear personal protective equipment.** Fragments of workpiece or of a broken accessory may fly away and cause injury beyond immediate area of operation.
- 10. Hold power tool by insulated gripping surfaces only, when performing an operation where the accessory may contact hidden wiring.** An accessory contacting a "live" wire may make exposed metal parts of the power tool "live" and shock the operator.
- 11. Never lay the air tool down until the accessory has come to a complete stop.** *The spinning accessory may grab the surface and pull the air tool out of your control.*
- 12. Do not run the air tool while carrying it at your side.** *Accidental contact with the spinning accessory could snag your clothing, pulling the accessory into your body.*
- 13. Regularly clean the power tool's air vents.** *The motor's fan will draw the dust inside the housing and excessive accumulation of powdered metal may cause electrical hazards.*
- 14. Do not operate the air tool near flammable materials.** *Sparks could ignite these materials.*
15. Attach all accessories properly to the tool before connecting the air supply. A loose accessory may detach or break during operation.
16. Obey the manual for the air compressor used to power this tool.
17. Install an in-line shutoff valve to allow immediate control over the air supply in an emergency, even if a hose is ruptured.
18. Maintain labels and nameplates on the tool. These carry important safety information. If unreadable or missing, contact Harbor Freight Tools for a replacement.

## Specific Safety Instructions (continued)

19. Avoid unintentional starting.  
Prepare to begin work before turning on the tool.
20. This product is not a toy.  
Keep it out of reach of children.
21. **WARNING:** Some dust created by power sanding, sawing, grinding, drilling, and other construction activities, contains chemicals known [to the State of California] to cause cancer, birth defects or other reproductive harm. Some examples of these chemicals are:
- Lead from lead-based paints
  - Crystalline silica from bricks and cement or other masonry products
  - Arsenic and chromium from chemically treated lumber
- Your risk from these exposures varies, depending on how often you do this type of work. To reduce your exposure to these chemicals: work in a well ventilated area, and work with approved safety equipment, such as those dust masks that are specially designed to filter out microscopic particles. (California Health & Safety Code § 25249.5, *et seq.*)
22. **WARNING:** The brass components of this product contain lead, a chemical known to the State of California to cause birth defects (or other reproductive harm). (California Health & Safety code § 25249.5, *et seq.*)
23. The warnings, precautions, and instructions discussed in this instruction manual cannot cover all possible conditions and situations that may occur. It must be understood by the operator that common sense and caution are factors which cannot be built into this product, but must be supplied by the operator.

## Vibration Precautions

This tool vibrates during use. Repeated or long-term exposure to vibration may cause temporary or permanent physical injury, particularly to the hands, arms and shoulders. To reduce the risk of vibration-related injury:

1. Anyone using vibrating tools regularly or for an extended period should first be examined by a doctor and then have regular medical check-ups to ensure medical problems are not being caused or worsened from use. Pregnant women or people who have impaired blood circulation to the hand, past hand injuries, nervous system disorders, diabetes, or Raynaud's Disease should not use this tool. If you feel any symptoms related to vibration (such as tingling, numbness, and white or blue fingers), seek medical advice as soon as possible.
2. Do not smoke during use. Nicotine reduces the blood supply to the hands and fingers, increasing the risk of vibration-related injury.
3. Wear suitable gloves to reduce the vibration effects on the user.
4. Use tools with the lowest vibration when there is a choice.
5. Include vibration-free periods each day of work.
6. Grip tool as lightly as possible (while still keeping safe control of it). Let the tool do the work.
7. To reduce vibration, maintain tool as explained in this manual. If abnormal vibration occurs, stop immediately.

## Specifications

Maximum Air Pressure	90 PSI	Maximum Speed*	9000 RPM
Air Inlet	1/4"–18 NPT	Air Consumption	7 CFM @ 90 PSI

\* Maximum speed at stated maximum air pressure. Excess air pressure is hazardous and may cause the tool to exceed stated maximum speed.

## Initial Set Up



Read the **ENTIRE IMPORTANT SAFETY INFORMATION** section at the beginning of this manual including all text under subheadings therein before set up or use of this product.

**Note:** For additional information regarding the parts listed in the following pages, refer to the Assembly Diagram near the end of this manual.

**Note:** This air tool may be shipped with a protective plug covering the air inlet. Remove this plug before set up.

## Air Supply Setup

### **⚠️ WARNING**



**TO PREVENT SERIOUS INJURY FROM EXPLOSION:**

**Use only clean, dry, regulated, compressed air to power this tool. Do not use oxygen, carbon dioxide, combustible gases, or any other bottled gas as a power source for this tool.**

1. Incorporate a filter, regulator with pressure gauge, in-line shutoff valve, and quick coupler for best service, as shown in Figure A on page 8 and Figure B on page 9.  
**An in-line shutoff ball valve is an important safety device because it controls the air supply even if the air hose is ruptured. The shutoff valve should be a ball valve because it can be closed quickly.**
2. Attach an air hose to the compressor's air outlet. Connect the air hose to the air inlet of the tool. Other components, such as a coupler plug and quick coupler, will make operation more efficient, but are not required.
3. Turn the tool's throttle or switch to the off position; refer to Operation section for description of controls.
4. Close the in-line shutoff valve between the compressor and the tool.
5. Turn on the air compressor according to the manufacturer's directions and allow it to build up pressure until it cycles off.
6. Adjust the air compressor's output regulator so that the air output is enough to properly power the tool, but the output will not exceed the tool's maximum air pressure at any time. Adjust the pressure gradually, while checking the air output gauge to set the right pressure range.
7. Inspect the air connections for leaks. Repair any leaks found.
8. If the tool will not be used at this time, turn off and detach the air supply and safely discharge any residual air pressure to prevent accidental operation.

### **⚠️ WARNING! TO PREVENT SERIOUS INJURY FROM ACCIDENTAL OPERATION:**

**Do not install a female quick coupler on the tool.** Such a coupler contains an air valve that will allow the air tool to retain pressure and operate accidentally after the air supply is disconnected.

**Note:** Air flow, and therefore tool performance, can be hindered by undersized air supply components.

**Note:** Residual air pressure should not be present after the tool is disconnected from the air supply. However, it is a good safety measure to attempt to discharge the tool in a safe fashion after disconnecting to ensure that the tool is disconnected and unpowered.

# CENTRALPNEUMATIC®

Figure A: Portable Air Supply Setup

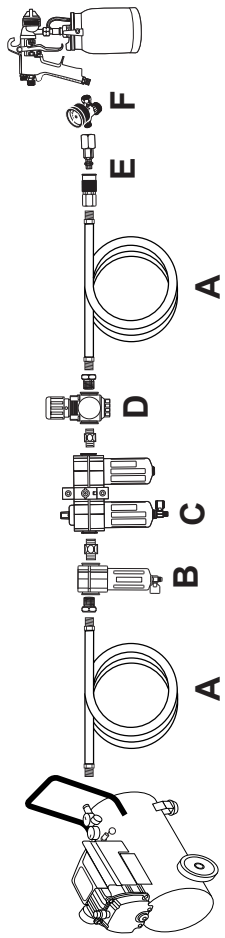

Description	Function
A Air Hose	Connects air to tool
B Filter	Prevents dirt and condensation from damaging tool or workpiece
D Regulator	Adjusts air pressure to tool
E Coupler and Plug	Provides quick connection and release
C Air Cleaner / Dryer*	Prevents water vapor from damaging workpiece
F Air Adjusting Valve*	For fine tuning airflow at tool

\*Optional components.



Figure B: Stationary Air Supply Setup

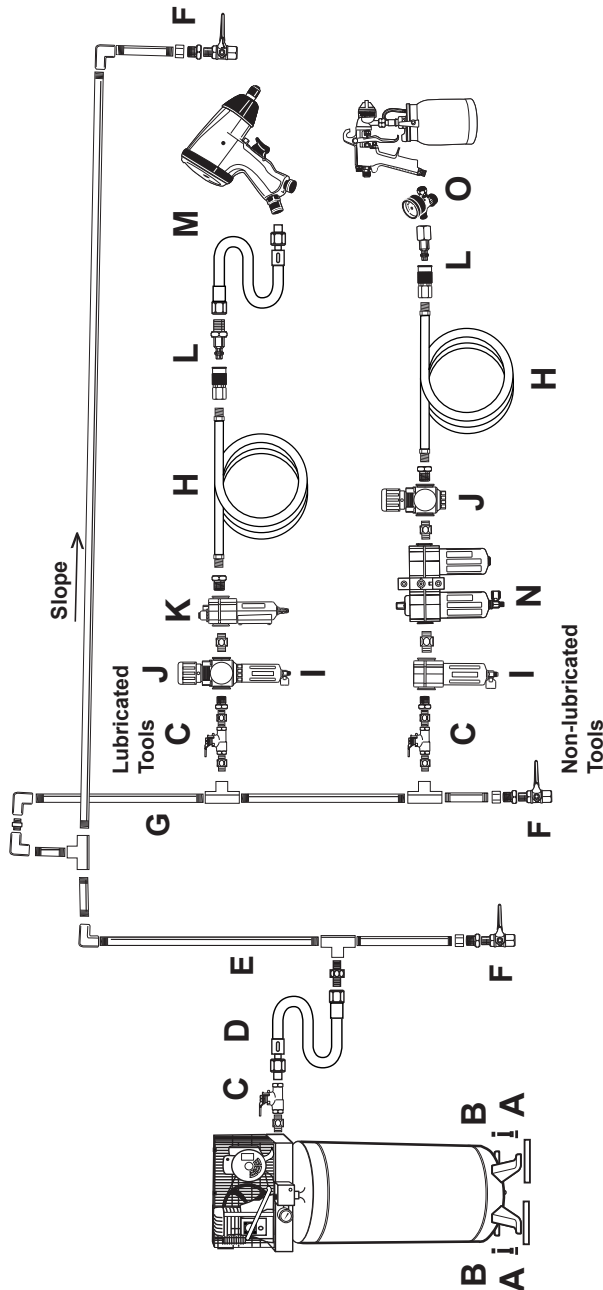

	Description	Function
I	Filter	Prevents dirt and condensation contamination
J	Regulator	Adjusts air pressure to tool
K	Lubricator*	For air tool lubrication
L	Coupler and Plug	Provides quick connection and release
M	Leader Hose*	Increases coupler life
N	Air Cleaner / Dryer*	Prevents moisture contamination
O	Air Adjusting Valve*	For fine tuning airflow at tool

	Description	Function
A	Vibration Pads	For noise and vibration reduction
B	Anchor Bolts	Secures air compressor in place
C	Ball Valve	Isolates sections of system for maintenance
D	Isolation Hose	For vibration reduction
E	Main Air Line - 3/4" min.	Distributes air to branch lines
F	Ball Valve	To drain moisture from system
G	Branch Air Line - 1/2" min.	Brings air to point of use
H	Air Hose	Connects air to tool

\*Optional components.

## Operating Instructions



Read the **ENTIRE IMPORTANT SAFETY INFORMATION** section at the beginning of this manual including all text under subheadings therein before set up or use of this product.

Inspect tool before use, looking for damaged, loose, and missing parts. If any problems are found, do not use tool until repaired.

## Workpiece and Work Area Set Up

1. Designate a work area that is clean and well-lit. The work area must not allow access by children or pets to prevent distraction and injury.
2. Route the air hose along a safe path to reach the work area without creating a tripping hazard or exposing the air hose to possible damage. The air hose must be long enough to reach the work area with enough extra length to allow free movement while working.
3. Secure loose workpieces using a vise or clamps (not included) to prevent movement while working.
4. There must not be hazardous objects (such as utility lines or foreign objects) nearby that will present a hazard while working.

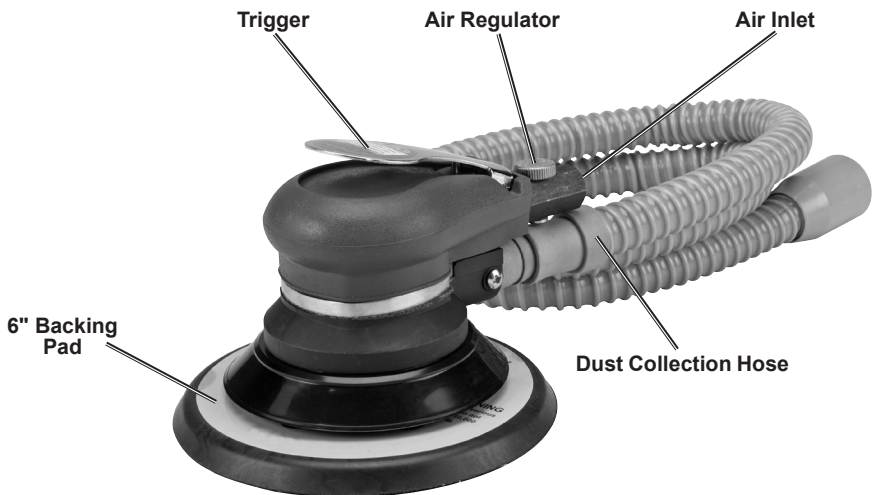

Figure C: Components and Controls

# Tool Set Up

## **⚠️ WARNING**

### **TO PREVENT SERIOUS INJURY FROM ACCIDENTAL OPERATION:**

Turn off the tool, detach the air supply, safely discharge any residual air pressure in the tool, and release the trigger before performing any inspection, maintenance, or cleaning procedures.

### **TO PREVENT SERIOUS INJURY:**

Do not adjust or tamper with any control or component in a way not specifically explained within this manual. Improper adjustment can result in tool failure or other serious hazards.

1. Attach Dust Collection Hose (46) to the Exhaust/Dust Collection Port (35). Attach Dust Bag (47) or dust collector to other end of hose.
2. 6" sandpaper discs (sold separately) attach to the Backing Pad (41) using a hook & loop system. Line up the six holes in the sanding disc with the six holes in the Backing Pad and press them together.

## General Operating Instructions

1. If an automatic oiler is not used, add a few drops of Pneumatic Tool Oil to the airline connection before use. Add a few drops more after each hour of continual use.
2. Wipe the work surface clean of all dirt and debris, especially that of previous coarser sanding sessions, which will scratch the surface of a finer grit sanding session.
3. Attach the desired grit sanding disc (sold separately) onto the Backing Pad.
4. Attach the air supply.
5. Pressing down on the Trigger with the palm of your hand starts the Sander. Grip the Sander but with the palm of the hand not pressing down. With the sanding pad placed flat on the working surface, press down on the Trigger with the palm of the hand to begin the sanding operation.
7. Keep heavy pressure off of the Sander when operating. Allow the sanding disc to do the work.
8. Move the Sander in a uniform pattern up and down or side to side to ensure even sanding.
9. Periodically, stop the Sander and check for possible disc wear. Replace used or worn sanding discs when necessary.
10. If the tool requires more force to accomplish the task, verify that the tool receives sufficient, unobstructed airflow (CFM) and increase the pressure (PSI) output of the regulator up to the maximum air pressure rating of this tool.

**Note:** Do not allow free, no-load rotating at high speed to avoid possible injury or damage to the tool.

**CAUTION!** Always start and stop the Sander while it is held firmly against the work surface. Applying the Sander to the workpiece while running with the sanding pad tilted will sand a groove into the workpiece and may cause the Sander to move in the direction of rotation, resulting in loss of control of the tool.

6. The speed of the Sander may be varied by turning the Air Regulator.

### **CAUTION! TO PREVENT INJURY FROM TOOL OR ACCESSORY FAILURE:**

**Do not exceed the tool's maximum air pressure rating.**

If the tool still does not have sufficient force at maximum pressure and sufficient airflow, then a larger tool may be required.

11. To prevent accidents, after use, release the Trigger, detach the air supply and then safely discharge any residual air pressure in the tool. Clean external surfaces of the tool with a clean, dry cloth. Then store the tool indoors out of children's reach.

## User-Maintenance Instructions



Procedures not specifically explained in this manual must be performed only by a qualified technician.

### **⚠ WARNING**

#### **TO PREVENT SERIOUS INJURY FROM ACCIDENTAL OPERATION:**

Turn off the tool, detach the air supply, safely discharge any residual air pressure in the tool, and release the trigger before performing any inspection, maintenance, or cleaning procedures.

#### **TO PREVENT SERIOUS INJURY FROM TOOL FAILURE: Do not use damaged equipment.**

If abnormal noise, vibration, or leaking air occurs, have the problem corrected before further use.



#### **TO PREVENT SERIOUS INJURY FROM EXPLOSION:**

Lubricate the tool only with specified lubricants. Lubricate the air inlet using only pneumatic tool oil. Other lubricants may damage the mechanism and may be highly flammable, causing an explosion.

## Cleaning, Maintenance, and Lubrication

**Note:** These procedures are in addition to the regular checks and maintenance explained as part of the regular operation of the air-operated tool.

- BEFORE EACH USE**, inspect the general condition of the tool. Check for:
  - loose hardware or housing
  - misalignment or binding of moving parts
  - cracked or broken parts
  - any other condition that may affect its safe operation.
- Daily - Air Supply Maintenance:**

Every day, maintain the air supply according to the component manufacturers' instructions. Maintain the lubricator's oil level. Drain the moisture filter regularly. Performing routine air supply maintenance will allow the tool to operate more safely and will also reduce wear on the tool.
- Weekly - Tool Maintenance:**

Drop some pneumatic tool oil into the air inlet of the tool and run the tool slowly for a minute before beginning work.

Check the inner dust collection port for sawdust buildup that would reduce the dust collection efficiency:

  - Remove the Backing Pad (41) as described in *Replacing the Backing Pad* below.
    - Inside the tool is the inner dust collection port where sawdust may accumulate. Keep this port opening clear using a toothpick and clean up with an old toothbrush.
    - Replace and secure the Backing Pad.
- Quarterly (every 3 months) – Tool Disassembly, Cleaning, and Inspection:**

Have the internal mechanism cleaned, inspected, and lubricated by a qualified technician. If the vanes need replacement, replace them all as a set.

### **Replacing the Backing Pad**

- Disconnect from air source.
- Slide the Wrench (39) between the Backing Pad (41) and the Flexible Rubber Cover (37) and engage the Backing Pad Retainer (28). Holding Wrench firmly, grasp Backing Pad and unscrew from Sander.
- Grasp Backing Pad Retainer firmly with Wrench and firmly screw new Backing Pad into Backing Pad Retainer.

# Troubleshooting

Problem	Possible Causes	Likely Solutions
Decreased output	<ol style="list-style-type: none"> <li>1. Not enough air pressure and/ or air flow.</li> <li>2. Obstructed Trigger.</li> <li>3. Incorrect lubrication or not enough lubrication.</li> <li>4. Blocked air inlet screen (if equipped).</li> <li>5. Air leaking from loose housing.</li> <li>6. Mechanism contaminated.</li> <li>7. Vane wear or damage.</li> </ol>	<ol style="list-style-type: none"> <li>1. Check for loose connections and make sure that air supply is providing enough air flow (CFM) at required pressure (PSI) to the tool's air inlet. <b>Do not exceed maximum air pressure.</b></li> <li>2. Clean around Trigger to ensure free movement.</li> <li>3. Lubricate using air tool oil according to directions.</li> <li>4. Clean air inlet screen of buildup.</li> <li>5. Make sure housing is properly assembled and tight.</li> <li>6. Have qualified technician clean and lubricate mechanism. Install in-line filter in air supply as stated in <i>Air Supply Setup</i> on page 7.</li> <li>7. Replace all vanes as set.</li> </ol>
Severe air leakage. (Slight air leakage is normal, especially on older tools.)	<ol style="list-style-type: none"> <li>1. Cross-threaded housing components.</li> <li>2. Loose housing.</li> <li>3. Damaged valve or housing.</li> <li>4. Dirty, worn or damaged valve.</li> </ol>	<ol style="list-style-type: none"> <li>1. Check for incorrect alignment and uneven gaps. If cross-threaded, disassemble and replace damaged parts before use.</li> <li>2. Tighten housing assembly. If housing cannot tighten properly, internal parts may be misaligned.</li> <li>3. Replace damaged components.</li> <li>4. Clean or replace valve assembly.</li> </ol>
Housing heats during use.	<ol style="list-style-type: none"> <li>1. Incorrect lubrication or not enough lubrication.</li> <li>2. Worn parts.</li> </ol>	<ol style="list-style-type: none"> <li>1. Lubricate using air tool oil according to directions.</li> <li>2. Have qualified technician inspect internal mechanism and replace parts as needed.</li> </ol>
<div style="display: flex; align-items: center;">  <p><b>Follow all safety precautions whenever diagnosing or servicing the tool. Disconnect air supply before service.</b></p> </div>		

## Parts List and Diagram

### Parts List

Part	Description	Qty
1	Trigger	1
2	Trigger Bolt	1
3	Outer Housing	1
4	Casing	1
5	Valve Core	1
7	Seal Ring	2
8	Seal Ring	1
9	Valve Needle	1
10	Spring	1
11	Bolt	1
12	Control Valve	1
13	Screw	2
14	Washer	1
15	Bearing 6000	1
16	Rear Plate	1
17	Rear Spacer	1
18	Cylinder	1
18-1	Spring Pin	3
19	Rotor	1
20	Vane	5
21	Bolt	3
22	O-Ring	1
23	Front Plate	1
24	Bearing 6000	1

Part	Description	Qty
25	Front Spacer	1
26	Spindle	1
27	Shaft Key	1
28	Backing Pad Retainer	1
29	Bearing 6001	1
30	Bearing 6001	1
31	Felt Ring	1
32	Cover	1
33	Clip Ring	1
34	Washer	1
35	Exhaust/Dust Collection Port	1
36	Base Ring	1
37	Flexible Rubber Cover	1
38	Set Screw	4
39	Wrench	1
40	Hex Screw	4
41	Backing Pad	1
42	Air Regulator	1
43	Seal Ring	1
44	Air Regulator Knob	1
45	O-Ring	1
46	Dust Collection Hose	1
47	Dust Bag	1

Record Product's Serial Number Here: \_\_\_\_\_

**Note:** If product has no serial number, record month and year of purchase instead.

**Note:** Some parts are listed and shown for illustration purposes only, and are not available individually as replacement parts.

# Assembly Diagram

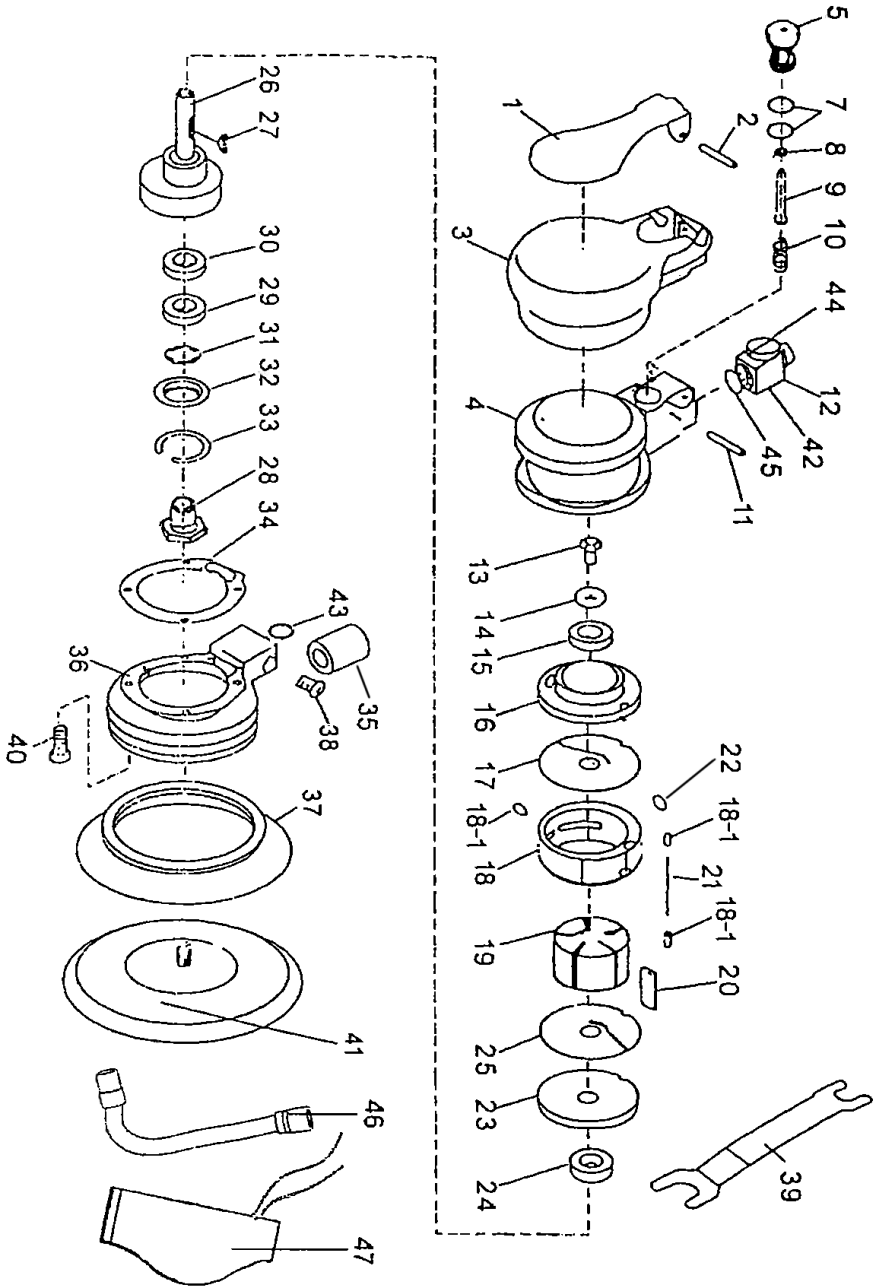

## PLEASE READ THE FOLLOWING CAREFULLY

---

THE MANUFACTURER AND/OR DISTRIBUTOR HAS PROVIDED THE PARTS LIST AND ASSEMBLY DIAGRAM IN THIS MANUAL AS A REFERENCE TOOL ONLY. NEITHER THE MANUFACTURER OR DISTRIBUTOR MAKES ANY REPRESENTATION OR WARRANTY OF ANY KIND TO THE BUYER THAT HE OR SHE IS QUALIFIED TO MAKE ANY REPAIRS TO THE PRODUCT, OR THAT HE OR SHE IS QUALIFIED TO REPLACE ANY PARTS OF THE PRODUCT. IN FACT, THE MANUFACTURER AND/OR DISTRIBUTOR EXPRESSLY STATES THAT ALL REPAIRS AND PARTS REPLACEMENTS SHOULD BE UNDERTAKEN BY CERTIFIED AND LICENSED TECHNICIANS, AND NOT BY THE BUYER. THE BUYER ASSUMES ALL RISK AND LIABILITY ARISING OUT OF HIS OR HER REPAIRS TO THE ORIGINAL PRODUCT OR REPLACEMENT PARTS THERETO, OR ARISING OUT OF HIS OR HER INSTALLATION OF REPLACEMENT PARTS THERETO.

### Limited 90 Day Warranty

Harbor Freight Tools Co. makes every effort to assure that its products meet high quality and durability standards, and warrants to the original purchaser that this product is free from defects in materials and workmanship for the period of 90 days from the date of purchase. This warranty does not apply to damage due directly or indirectly, to misuse, abuse, negligence or accidents, repairs or alterations outside our facilities, criminal activity, improper installation, normal wear and tear, or to lack of maintenance. We shall in no event be liable for death, injuries to persons or property, or for incidental, contingent, special or consequential damages arising from the use of our product. Some states do not allow the exclusion or limitation of incidental or consequential damages, so the above limitation of exclusion may not apply to you. THIS WARRANTY IS EXPRESSLY IN LIEU OF ALL OTHER WARRANTIES, EXPRESS OR IMPLIED, INCLUDING THE WARRANTIES OF MERCHANTABILITY AND FITNESS.

To take advantage of this warranty, the product or part must be returned to us with transportation charges prepaid. Proof of purchase date and an explanation of the complaint must accompany the merchandise. If our inspection verifies the defect, we will either repair or replace the product at our election or we may elect to refund the purchase price if we cannot readily and quickly provide you with a replacement. We will return repaired products at our expense, but if we determine there is no defect, or that the defect resulted from causes not within the scope of our warranty, then you must bear the cost of returning the product.

This warranty gives you specific legal rights and you may also have other rights which vary from state to state.

# CENTRALPNEUMATIC®